



FEATURES

- RoHS compliant
- Toroidal construction minimizes EMI
- Compact size
- Surface mount
- UL94 V-0 package materials
- Pick & place compatible
- J-STD-020C reflow
- Backward compatible with Sn/Pb soldering systems

DESCRIPTION

The 4300 series is a range of surface mount dual-winding toroidal inductors designed for use in switching power supplies and DC/DC converters. These devices can also be used as common-mode chokes, as the windings have a 1:1 ratio. They are ideal for applications requiring low profile compact components in a surface mount package.

SELECTION GUIDE

Order Code	Inductance (100kHz, 0.1V _{AC}) ¹ ±15% μH	DC Current ² Max. A	DC Resistance Max. mΩ	SRF Min. MHz	Package Dimensions (Max.)		Pad Dimensions		Carrier Tape Dimensions		Package Weight Typ. g
					A mm	B mm	C mm	D mm	E mm	F mm	
43212C	2.10	21	2.22	106	20.30	23.10	11.18	20.57	32.0	10.3	7.4
43402C	4.00	22.4	3.10	69	25.40	28.20	15.75	25.65	36.0	10.6	12.5

ABSOLUTE MAXIMUM RATINGS

Isolation voltage (flash tested for 1 second), pins 1 & 2	500V _{DC}
Operating temperature range	-40°C to +125°C
Storage temperature range	-40°C to +130°C

SOLDERING INFORMATION³

Peak reflow temperature	245°C
Pin finish	Pure tin dip
Moisture sensitivity level	1

PACKAGING INFORMATION

	43212C	43402C
Tape & Reel (add suffix -R to part No. e.g. 43212C-R)	180 per reel	160 per reel
Box	35 per box	20 per box

All specifications typical at T_A=25°C

- 1 When connecting windings in series, inductance will be 4 times the figure shown.
- 2 With windings connected in parallel. Maximum DC current occurs when the temperature rise reaches 55°C.
- 3 For further information, please visit www.murata-ps.com/rohs



INDUCTANCE Vs CURRENT

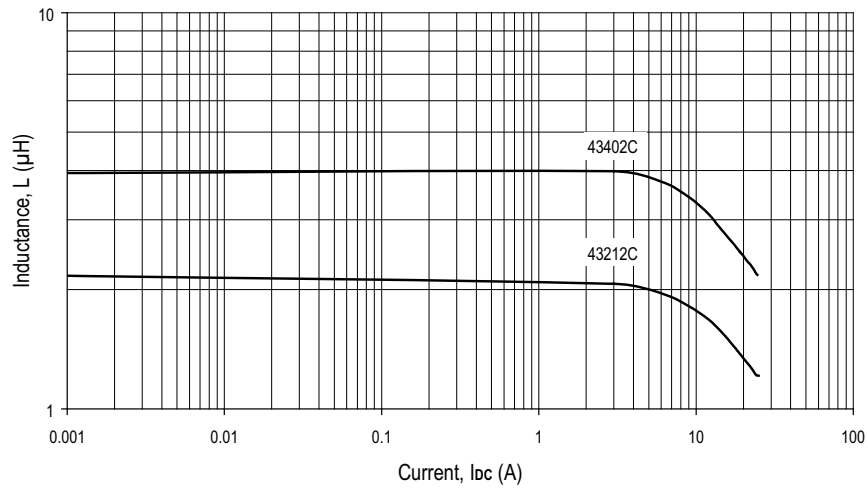

TEMPERATURE Vs CURRENT

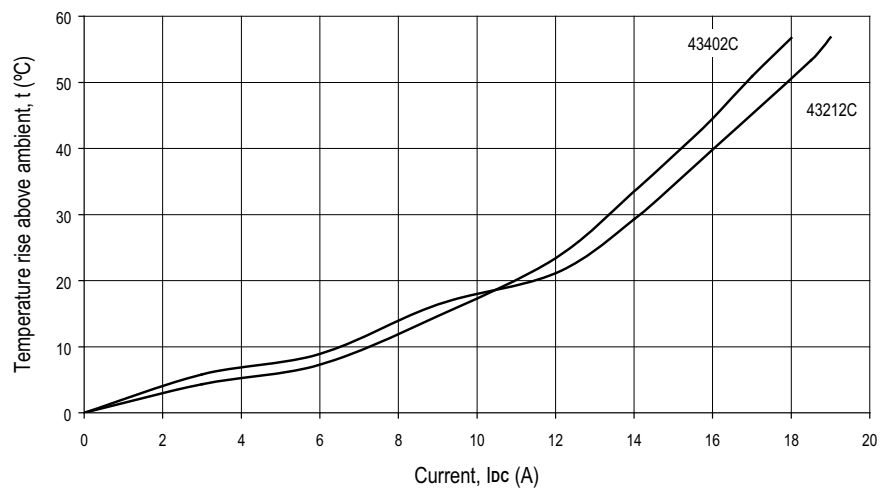

INDUCTANCE Vs FREQUENCY

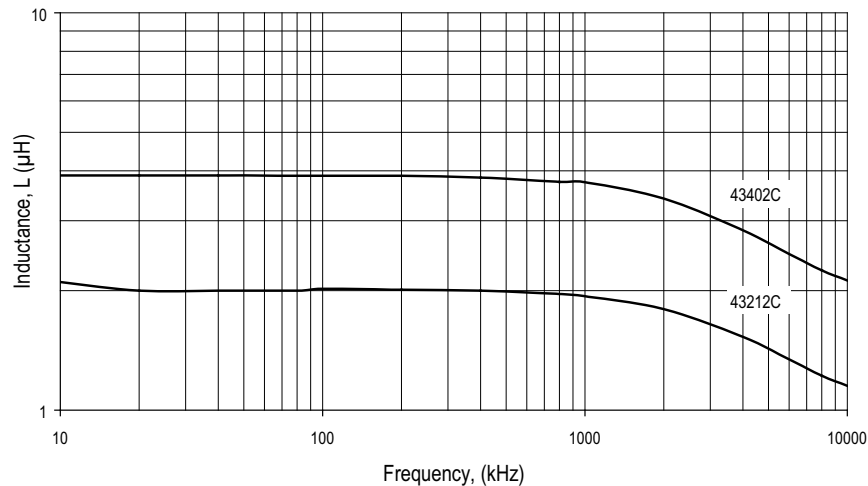

PACKAGE SPECIFICATIONS

MECHANICAL DIMENSIONS

See Selection Guide for dimensions.

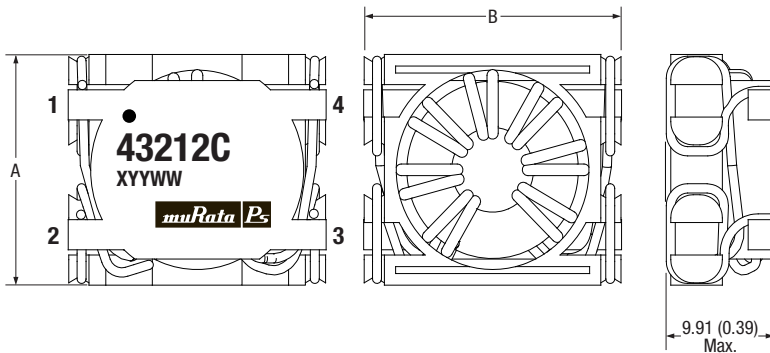

RECOMMENDED FOOTPRINT DETAILS

See Selection Guide for dimensions.

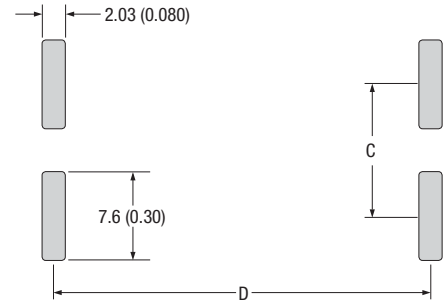

All dimensions in mm (inches).

SCHEMATIC

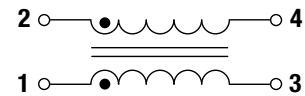

TAPE & REEL SPECIFICATIONS

TAPE OUTLINE DIMENSIONS

See Selection Guide for dimensions.

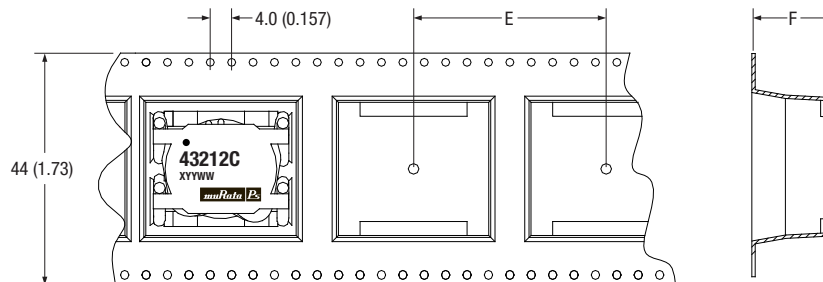

All dimensions in mm (inches).
 See Selection Guide for package quantities.

Murata Power Solutions, Inc.
 11 Cabot Boulevard, Mansfield, MA 02048-1151 U.S.A.
 Tel: (508) 339-3000 (800) 233-2765 Fax: (508) 339-6356
www.murata-ps.com email: sales@murata-ps.com ISO 9001 REGISTERED

Murata Power Solutions, Inc. makes no representation that the use of its products in the circuits described herein, or the use of other technical information contained herein, will not infringe upon existing or future patent rights. The descriptions contained herein do not imply the granting of licenses to make, use, or sell equipment constructed in accordance therewith. Specifications are subject to change without notice.
 © 2008 Murata Power Solutions, Inc.

- USA:** Mansfield (MA), Tel: (800) 233 2765, email: sales@murata-ps.com
- Canada:** Toronto, Tel: (866) 740 1232, email: toronto@murata-ps.com
- UK:** Milton Keynes, Tel: +44 (0)1908 615232, email: mk@murata-ps.com
- France:** Montigny Le Bretonneux, Tel: +33 (0)1 34 60 01 01, email: france@murata-ps.com
- Germany:** München, Tel: +49 (0)89-544334-0, email: munich@murata-ps.com
- Japan:** Tokyo, Tel: 3-3779-1031, email: sales_tokyo@murata-ps.com
 Osaka, Tel: 6-6354-2025, email: sales_osaka@murata-ps.com
Website: www.murata-ps.jp
- China:** Shanghai, Tel: +86 215 027 3678, email: shanghai@murata-ps.com
 Guangzhou, Tel: +86 208 221 8066, email: guangzhou@murata-ps.com