

Optocoupler, Phototransistor Output, Very High Isolation Voltage

Features

- Rated isolation voltage (RMS includes DC)
 $V_{IOWM} = 1000 V_{RMS}$ (1450 V peak)
- Rated recurring peak voltage (repetitive)
 $V_{IORM} = 1000 V_{RMS}$
- Thickness through insulation ≥ 3 mm
- Creepage current resistance according to VDE 0303/IEC 60112 Comparative Tracking Index:
CTI ≥ 200
- Lead-free component
- Component in accordance to RoHS 2002/95/EC and WEEE 2002/96/EC

Agency Approvals

- UL1577, File No. E76222 System Code H,J &K, Double Protection
- DIN EN 60747-5-2 (VDE0884)
 DIN EN 60747-5-5 pending
- VDE related features:
- Rated impulse voltage (transient overvoltage)
 $V_{IOTM} = 8$ kV peak
- Isolation test voltage (partial discharge test voltage) $V_{pd} = 2.8$ kV peak

Applications

Circuits for safe protective separation against electrical shock according to safety class II (reinforced isolation):

For appl. class I - IV at mains voltage ≤ 300 V

For appl. class I - IV at mains voltage ≤ 600 V

For appl. class I - III at mains voltage ≤ 1000 V according to DIN EN 60747-5-2(VDE0884)/ DIN EN 60747-5-5 pending, table 2, suitable for:

Switch-mode power supplies, line receiver, computer peripheral interface, microprocessor system interface.

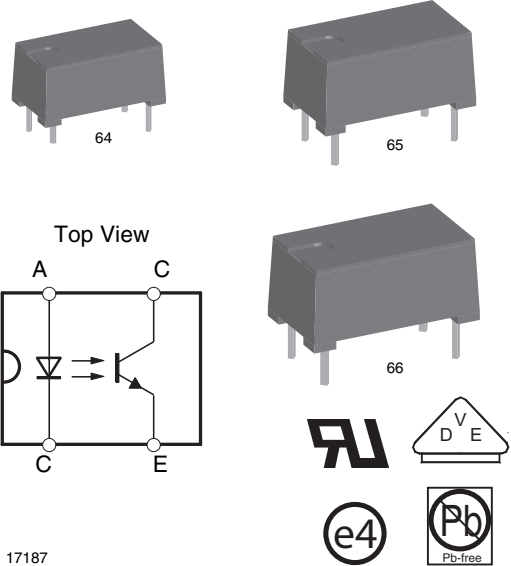

17187

Order Information

Part	Remarks
CNY64	CTR 50 - 300 %, High Isolation Distance, 4 PIN
CNY65	CTR 50 - 300 %, High Isolation Distance, 4 PIN
CNY66	CTR 50 - 300 %, High Isolation Distance, 4 PIN
CNY64A	CTR 63 - 125 %, High Isolation Distance, 4 PIN
CNY65A	CTR 63 - 125 %, High Isolation Distance, 4 PIN
CNY64B	CTR 100 - 200 %, High Isolation Distance, 4 PIN
CNY65B	CTR 100 - 200 %, High Isolation Distance, 4 PIN

Description

The CNY64/ CNY65/ CNY66 consist of a phototransistor optically coupled to a gallium arsenide infrared-emitting diode in a 4-pin plastic package.

The single components are mounted opposite one another, providing a distance between input and output for highest safety requirements of > 3 mm.

VDE Standards

These couplers perform safety functions according to the following equipment standards:

DIN EN 60747-5-2(VDE0884)/ DIN EN 60747-5-5 pending

Optocoupler for electrical safety requirements
IEC 60950/EN 60950

Office machines (applied for reinforced isolation for mains voltage ≤ 400 VRMS)

VDE 0804

Telecommunication apparatus and data processing

IEC 60065

Safety for mains-operated electronic and related household apparatus

VDE 0700/IEC 60335

Household equipment

VDE 0160

Electronic equipment for electrical power installation

VDE 0750/IEC 60601

Medical equipment

Absolute Maximum Ratings

$T_{amb} = 25$ °C, unless otherwise specified

Stresses in excess of the absolute Maximum Ratings can cause permanent damage to the device. Functional operation of the device is not implied at these or any other conditions in excess of those given in the operational sections of this document. Exposure to absolute Maximum Rating for extended periods of the time can adversely affect reliability.

Input

Parameter	Test condition	Symbol	Value	Unit
Reverse voltage		V_R	5	V
Forward current		I_F	75	mA
Forward surge current	$t_p \leq 10$ μ s	I_{FSM}	1.5	A
Power dissipation		P_{diss}	120	mW
Junction temperature		T_j	100	°C

Output

Parameter	Test condition	Symbol	Value	Unit
Collector emitter voltage		V_{CEO}	32	V
Emitter collector voltage		V_{ECO}	7	V
Collector current		I_C	50	mA
Collector peak current	$t_p/T = 0.5$, $t_p \leq 10$ ms	I_{CM}	100	mA
Power dissipation		P_{diss}	130	mW
Junction temperature		T_j	100	°C

Coupler

Parameter	Test condition	Symbol	Value	Unit
AC isolation test voltage (RMS)	$t = 1$ min	V_{ISO}	8.2	kV
Total power dissipation		P_{tot}	250	mW
Ambient temperature range		T_{amb}	- 55 to + 85	°C
Storage temperature range		T_{stg}	- 55 to + 100	°C
Soldering temperature	2 mm from case, $t \leq 10$ s	T_{sld}	260	°C

Electrical Characteristics

$T_{amb} = 25\text{ }^{\circ}\text{C}$, unless otherwise specified

Minimum and maximum values are testing requirements. Typical values are characteristics of the device and are the result of engineering evaluation. Typical values are for information only and are not part of the testing requirements.

Input

Parameter	Test condition	Symbol	Min	Typ.	Max	Unit
Forward voltage	$I_F = 50\text{ mA}$	V_F		1.25	1.6	V
Junction capacitance	$V_R = 0, f = 1\text{ MHz}$	C_j		50		pF

Output

Parameter	Test condition	Symbol	Min	Typ.	Max	Unit
Collector emitter voltage	$I_C = 1\text{ mA}$	V_{CEO}	32			V
Emitter collector voltage	$I_E = 100\text{ }\mu\text{A}$	V_{ECO}	7			V
Collector-emitter leakage current	$V_{CE} = 20\text{ V}, I_f = 0$	I_{CEO}			200	nA

Coupler

Parameter	Test condition	Symbol	Min	Typ.	Max	Unit
Collector emitter saturation voltage	$I_F = 10\text{ mA}, I_C = 1\text{ mA}$	V_{CEsat}			0.3	V
Cut-off frequency	$V_{CE} = 5\text{ V}, I_F = 10\text{ mA}, R_L = 100\text{ }\Omega$	f_c		110		kHz
Coupling capacitance	$f = 1\text{ MHz}$	C_k		0.3		pF

Current Transfer Ratio

Parameter	Test condition	Part	Symbol	Min	Typ.	Max	Unit
I_C/I_F	$V_{CE} = 5\text{ V}, I_F = 10\text{ mA}$		CTR	50		300	%
		CNY64A	CTR	63		125	%
		CNY65A	CTR	63		125	%
		CNY64B	CTR	100		200	%
		CNY65B	CTR	100		200	%

Maximum Safety Ratings

(according to DIN EN 60747-5-2(VDE0884)/ DIN EN 60747-5-5 pending) see figure 1

This optocoupler is suitable for safe electrical isolation only within the safety ratings.

Compliance with the safety ratings shall be ensured by means of suitable protective circuits.

Input

Parameter	Test condition	Symbol	Min	Typ.	Max	Unit
Forward current		I_F			120	mA

Output

Parameter	Test condition	Symbol	Min	Typ.	Max	Unit
Power dissipation		P_{diss}			250	mW

Coupler

Parameter	Test condition	Symbol	Min	Typ.	Max	Unit
Rated impulse voltage		V_{IOTM}			8	kV
Safety temperature		T_{si}			150	°C

Insulation Rated Parameters

Parameter	Test condition	Symbol	Min	Typ.	Max	Unit
Partial discharge test voltage - Routine test	100 %, $t_{test} = 1$ s	V_{pd}	2.8			kV
Partial discharge test voltage - Lot test (sample test)	$t_{Tr} = 60$ s, $t_{test} = 10$ s, (see figure 2)	V_{IOTM}	8			kV
		V_{pd}	2.2			kV
Insulation resistance	$V_{IO} = 500$ V, $T_{amb} = 25$ °C	R_{IO}	10^{12}			Ω
	$V_{IO} = 500$ V, $T_{amb} = 100$ °C	R_{IO}	10^{11}			Ω
	$V_{IO} = 500$ V, $T_{amb} = 150$ °C (construction test only)	R_{IO}	10^9			Ω

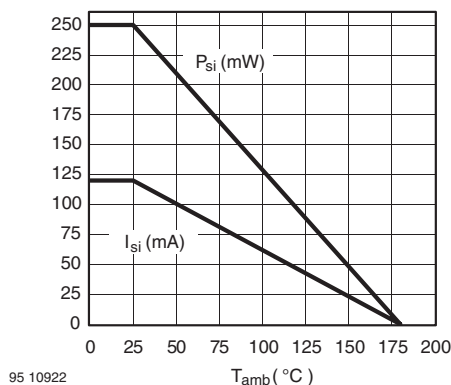

Figure 1. Derating diagram



Figure 2. Test pulse diagram for sample test according to DIN EN 60747-5-2(VDE0884)/ DIN EN 60747-; IEC60747

Switching Characteristics

Parameter	Test condition	Symbol	Min	Typ.	Max	Unit
Delay time	$V_S = 5\text{ V}$, $I_C = 5\text{ mA}$, $R_L = 100\ \Omega$ (see figure 3)	t_d		2.6		μS
Rise time	$V_S = 5\text{ V}$, $I_C = 5\text{ mA}$, $R_L = 100\ \Omega$ (see figure 3)	t_r		2.4		μS
Fall time	$V_S = 5\text{ V}$, $I_C = 5\text{ mA}$, $R_L = 100\ \Omega$ (see figure 3)	t_f		2.7		μS
Storage time	$V_S = 5\text{ V}$, $I_C = 5\text{ mA}$, $R_L = 100\ \Omega$ (see figure 3)	t_s		0.3		μS
Turn-on time	$V_S = 5\text{ V}$, $I_C = 5\text{ mA}$, $R_L = 100\ \Omega$ (see figure 3)	t_{on}		5.0		μS
Turn-off time	$V_S = 5\text{ V}$, $I_C = 5\text{ mA}$, $R_L = 100\ \Omega$ (see figure 3)	t_{off}		3.0		μS
Turn-on time	$V_S = 5\text{ V}$, $I_F = 10\text{ mA}$, $R_L = 1\text{ k}\Omega$ (see figure 4)	t_{on}		25.0		μS
Turn-off time	$V_S = 5\text{ V}$, $I_F = 10\text{ mA}$, $R_L = 1\text{ k}\Omega$ (see figure 4)	t_{off}		42.5		μS

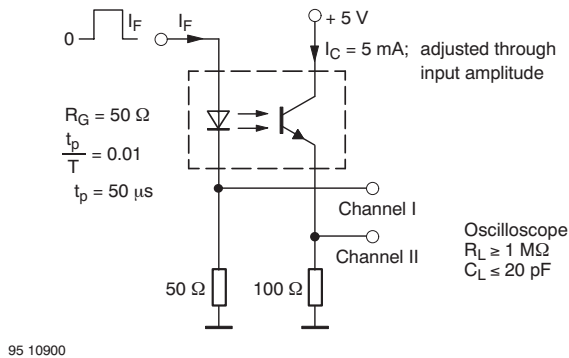

Figure 3. Test circuit, non-saturated operation

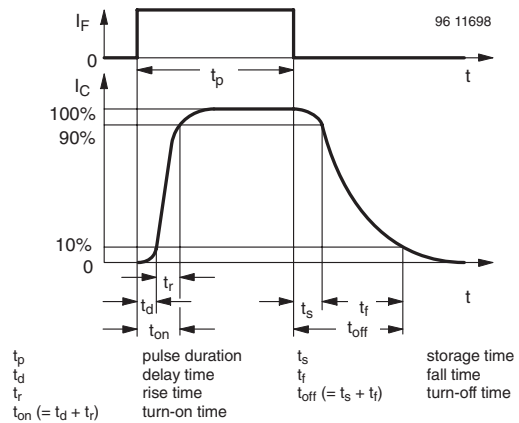

Figure 5. Switching Times

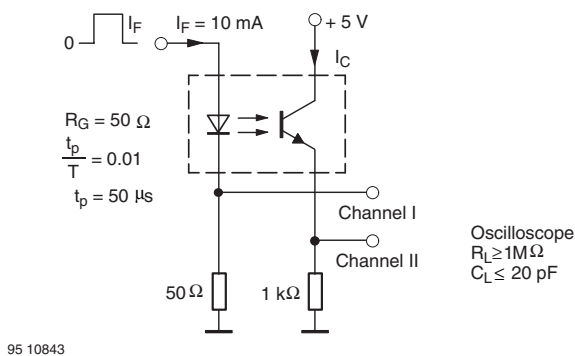

Figure 4. Test circuit, saturated operation

Typical Characteristics (T_{amb} = 25 °C unless otherwise specified)

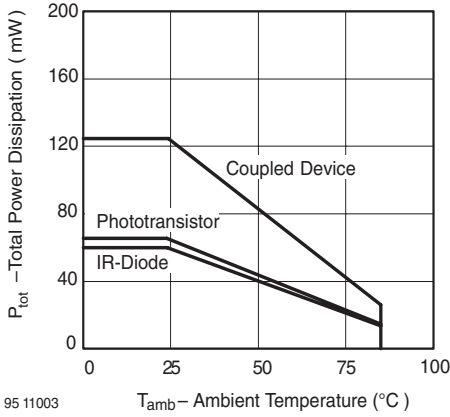

Figure 6. Total Power Dissipation vs. Ambient Temperature

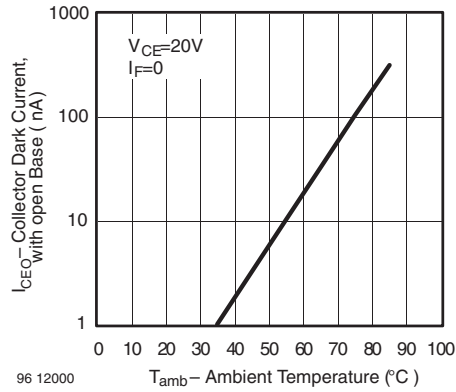

Figure 9. Collector Dark Current vs. Ambient Temperature

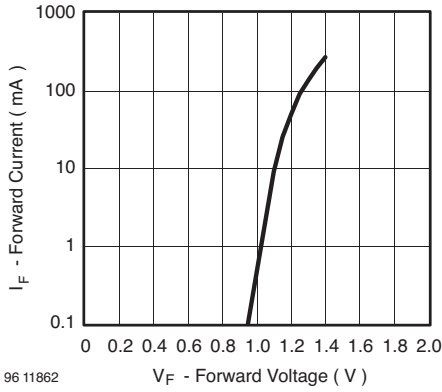

Figure 7. Forward Current vs. Forward Voltage

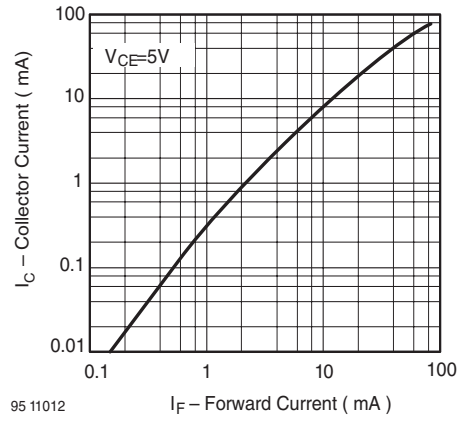

Figure 10. Collector Current vs. Forward Current

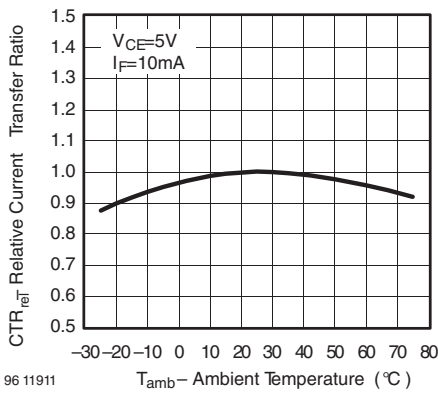

Figure 8. Relative Current Transfer Ratio vs. Ambient Temperature

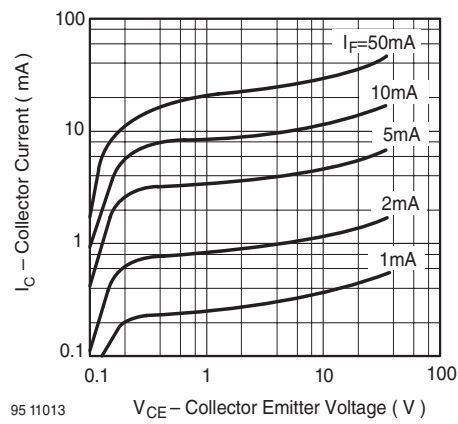
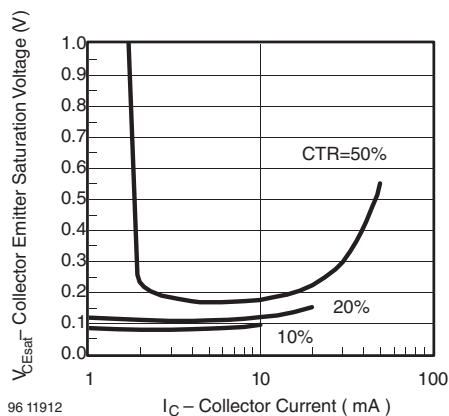
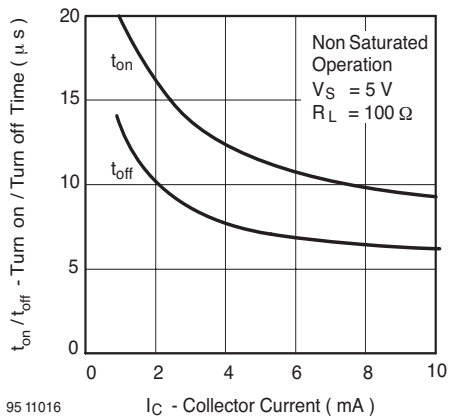

Figure 11. Collector Current vs. Collector Emitter Voltage



96 11912

Figure 12. Collector Emitter Saturation Voltage vs. Collector Current



95 11016

Figure 15. Turn on / off Time vs. Collector Current

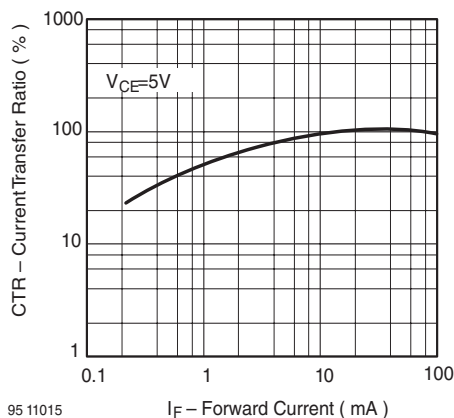

95 11015

Figure 13. Current Transfer Ratio vs. Forward Current

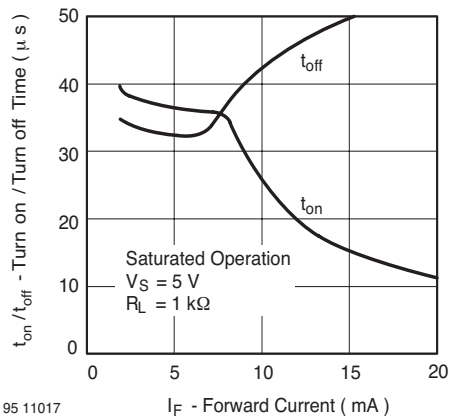

95 11017

Figure 14. Turn on / off Time vs. Forward Current

CNY64/ CNY65/ CNY66



Visay Semiconductor 查询CNY64,65,66供应商

Package Dimensions in mm

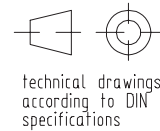
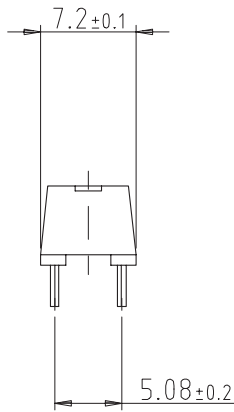
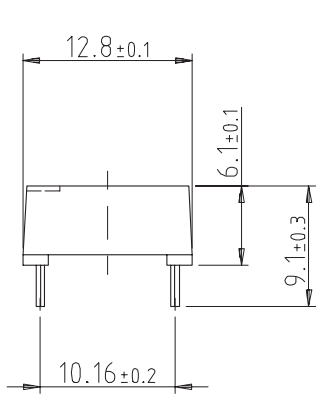

technical drawings according to DIN specifications

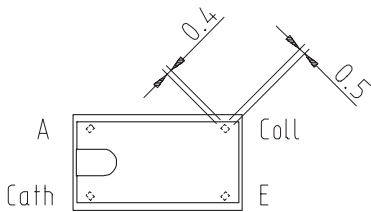

weight : ca 0.73g
 creepage distance : > 9.5mm
 air path : > 9.5mm
 after mounting on PC board

14765

Package Dimensions in mm

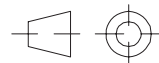
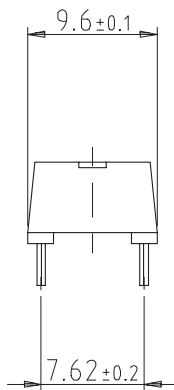
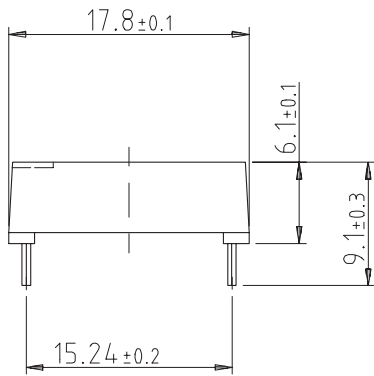

technical drawings according to DIN specifications

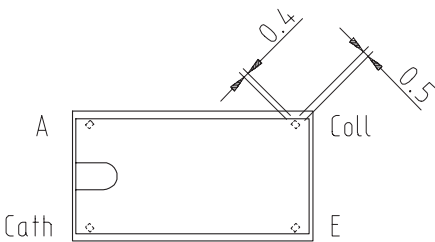

weight : ca 1.40g
 creepage distance : > 14mm
 air path : > 14mm
 after mounting on PC board

14763

Package Dimensions in mm

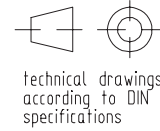
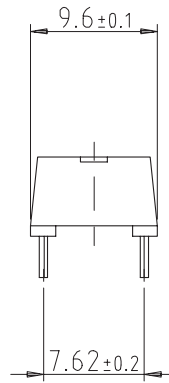
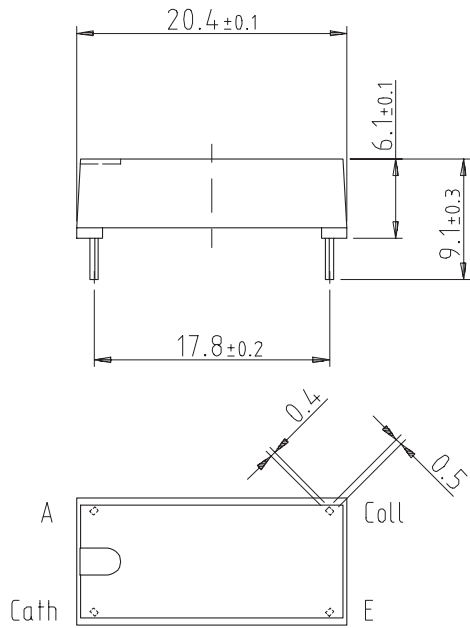

weight : ca 1.70g
 creepage distance : > 17mm
 air path : > 17mm
 after mounting on PC board

14764

Ozone Depleting Substances Policy Statement

It is the policy of Vishay Semiconductor GmbH to

1. Meet all present and future national and international statutory requirements.
2. Regularly and continuously improve the performance of our products, processes, distribution and operating systems with respect to their impact on the health and safety of our employees and the public, as well as their impact on the environment.

It is particular concern to control or eliminate releases of those substances into the atmosphere which are known as ozone depleting substances (ODSs).

The Montreal Protocol (1987) and its London Amendments (1990) intend to severely restrict the use of ODSs and forbid their use within the next ten years. Various national and international initiatives are pressing for an earlier ban on these substances.

Vishay Semiconductor GmbH has been able to use its policy of continuous improvements to eliminate the use of ODSs listed in the following documents.

1. Annex A, B and list of transitional substances of the Montreal Protocol and the London Amendments respectively
2. Class I and II ozone depleting substances in the Clean Air Act Amendments of 1990 by the Environmental Protection Agency (EPA) in the USA
3. Council Decision 88/540/EEC and 91/690/EEC Annex A, B and C (transitional substances) respectively.

Vishay Semiconductor GmbH can certify that our semiconductors are not manufactured with ozone depleting substances and do not contain such substances.

We reserve the right to make changes to improve technical design and may do so without further notice.

Parameters can vary in different applications. All operating parameters must be validated for each customer application by the customer. Should the buyer use Vishay Semiconductors products for any unintended or unauthorized application, the buyer shall indemnify Vishay Semiconductors against all claims, costs, damages, and expenses, arising out of, directly or indirectly, any claim of personal damage, injury or death associated with such unintended or unauthorized use.

Vishay Semiconductor GmbH, P.O.B. 3535, D-74025 Heilbronn, Germany
Telephone: 49 (0)7131 67 2831, Fax number: 49 (0)7131 67 2423



Notice

Specifications of the products displayed herein are subject to change without notice. Vishay Intertechnology, Inc., or anyone on its behalf, assumes no responsibility or liability for any errors or inaccuracies.

Information contained herein is intended to provide a product description only. No license, express or implied, by estoppel or otherwise, to any intellectual property rights is granted by this document. Except as provided in Vishay's terms and conditions of sale for such products, Vishay assumes no liability whatsoever, and disclaims any express or implied warranty, relating to sale and/or use of Vishay products including liability or warranties relating to fitness for a particular purpose, merchantability, or infringement of any patent, copyright, or other intellectual property right.

The products shown herein are not designed for use in medical, life-saving, or life-sustaining applications. Customers using or selling these products for use in such applications do so at their own risk and agree to fully indemnify Vishay for any damages resulting from such improper use or sale.