



查询"100175DC"供应商

Not Intended For New Designs

T-46-07-01

100175 Quint Latch 100K In/10K Out

General Description

The 100175 is a 5-bit latch with temperature and voltage compensated 100K compatible inputs and voltage compensated 10K compatible outputs. Each latch has one data input and one output. All five latches share a common clear input and one output. All inputs have 50 kΩ pull-down resistors.

Features

- Outputs specified to drive a 50Ω load
- Available in 16-pin ceramic DIP
- 100K compatible inputs/10K compatible outputs

Ordering Code: See Section 6

Logic Symbol

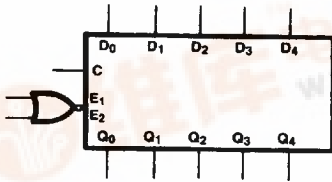

TL/F/9870-2

Pin Names	Description
D ₀ -D ₄	100K Data Inputs
E ₁ , E ₂	100K Enable Inputs
C	100K Common Clear Input
Q ₀ -Q ₄	10K Data Outputs

Connection Diagram

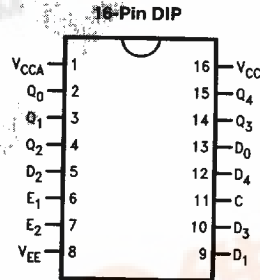

TL/F/9870-1

Logic Diagram

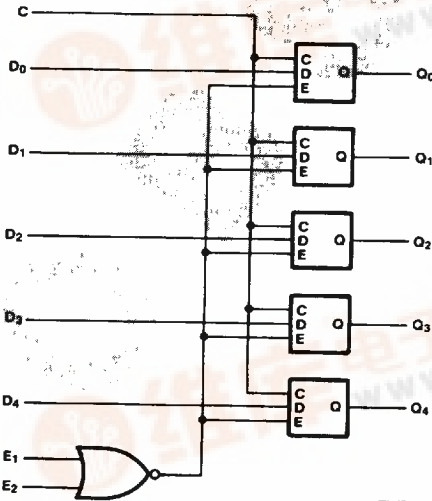

TL/F/9870-3

Truth Table

Inputs				Output
D _n	E ₁	E ₂	C	Q _n
H	L	L	X	H
L	L	L	X	L
X	H	X	L	Q _{n-1}
X	X	H	L	Q _{n-1}
X	H	X	H	L
X	X	H	H	L

H = HIGH Voltage Level

L = LOW Voltage Level

X = Don't Care

Q_{n-1} = Previous State

100175

Absolute Maximum Ratings

Above which the useful life may be impaired

For Military/Aerospace specified devices are required, please contact the National Semiconductor Sales Office/Distributors for availability and specifications.

Storage Temperature	-65°C to +150°C
Ambient Temperature Under Bias (T _A)	-55°C to +125°C
Maximum Junction Temperature (T _J)	+150°C
Supply Voltage	-8V
Input Voltage (DC)	-5.2V to +0V
Output Current (DC Output HIGH)	-55 mA
Operating Range	-5.72V to -4.68V
Lead Temperature (Soldering, 10 sec.)	300°C

Recommended Operating Conditions

	Min	Typ	Max
Supply Voltage (V _{EE})	-5.72V	-5.2V	-4.68V
Ambient Temperature (T _A)	0°C		+75°C

DC Electrical Characteristics

V_{EE} = -5.2V, V_{CC} = V_{CCA} = GND, T_A = 0°C to +75°C (Notes 1, 2)

Symbol	Parameter	Temp	Min	Typ	Max	Units	Conditions
V _{OH}	Output HIGH Voltage	T _A = 0°C	-1000		-840	mV	V _{IN} = V _{IH} (Max) or V _{IL} (Min)
		T _A = +25°C	-960		-810	mV	
		T _A = +75°C	-900		-720	mV	
V _{OL}	Output LOW Voltage	T _A = 0°C	-1870		-1665	mV	V _{IN} = V _{IH} (Max) or V _{IL} (Min)
		T _A = +25°C	-1850		-1650	mV	
		T _A = +75°C	-1830		-1625	mV	
V _{OHC}	Output HIGH Voltage	T _A = 0°C	-1020			mV	V _{IN} = V _{IH} (Min) or V _{IL} (Max)
		T _A = +25°C	-980			mV	
		T _A = +75°C	-920			mV	
V _{OLC}	Output LOW Voltage	T _A = 0°C			-1645	mV	V _{IN} = V _{IH} (Min) or V _{IL} (Max)
		T _A = +25°C			-1630	mV	
		T _A = +75°C			-1605	mV	
V _{IH}	Input HIGH Voltage		-1165		-880	mV	Guaranteed HIGH Signal for All Inputs
V _{IL}	Input LOW Voltage		-1810		-1475	mV	Guaranteed LOW Signal for All Inputs
I _{IH}	Input HIGH Current				290		V _{IN} = V _{IH} (Max)
I _{IL}	Input LOW Current		0.50			μA	V _{IN} = V _{IL} (Min)
I _{EE}	V _{EE} Supply Current		-125	-90	-50	mA	Inputs Open

Note 1: The specified limits represent the "worst case" value for the parameter. Since these "worst case" values normally occur at the temperature extremes, additional noise immunity and guard banding can be achieved by decreasing the allowable system operating ranges.

Note 2: The specified limits shown in the DC Characteristics can be met only after thermal equilibrium has been established. Thermal equilibrium is established by applying power for at least 2 minutes while maintaining transverse air flow of 2.5 meters/s (500 linear feet/min) over the device either mounted in the test socket or on the printed circuit board. Test voltage values are given in the DC Operating Conditions and defined in Figure 4.

100175

DC Electrical Characteristics

$V_{EE} = -4.68V$, $V_{CC} = V_{CCA} = GND$, $T_A = 0^{\circ}C$ to $+75^{\circ}C$ (Notes 1, 2)

Symbol	Parameter	Temp	Min	Typ	Max	Units	Conditions
V_{OH}	Output HIGH Voltage	$T_A = 0^{\circ}C$	-1000		-840	mV	$V_{IN} = V_{IH} (Max)$ or $V_{IL} (Min)$
		$T_A = +25^{\circ}C$	-960		-810	mV	
		$T_A = +75^{\circ}C$	-900		-720	mV	
V_{OL}	Output LOW Voltage	$T_A = 0^{\circ}C$	-1870		-1665	mV	$V_{IN} = V_{IH} (Max)$ or $V_{IL} (Min)$
		$T_A = +25^{\circ}C$	-1850		-1650	mV	
		$T_A = +75^{\circ}C$	-1830		-1625	mV	
V_{OHC}	Output HIGH Voltage	$T_A = 0^{\circ}C$	-1020			mV	Loading with 50Ω to $-2.0V$
		$T_A = +25^{\circ}C$	-980			mV	
		$T_A = +75^{\circ}C$	-920			mV	
V_{OLC}	Output LOW Voltage	$T_A = 0^{\circ}C$			-1645	mV	$V_{IN} = V_{IH} (Min)$ or $V_{IL} (Max)$
		$T_A = +25^{\circ}C$			-1630	mV	
		$T_A = +75^{\circ}C$			-1605	mV	
V_{IH}	Input HIGH Voltage		-1150		-880	mV	Guaranteed HIGH Signal for All Inputs
V_{IL}	Input LOW Voltage		-1810		-1475	mV	Guaranteed LOW Signal for All Inputs
I_{IH}	Input HIGH Current				290		$V_{IN} = V_{IH} (Max)$
I_{IL}	Input LOW Current		0.50			μA	$V_{IN} = V_{IL} (Min)$
I_{EE}	V_{EE} Supply Current		-125	-90	-50	mA	Inputs Open

Note 1: The specified limits represent the "worst case" value for the parameter. Since these "worst case" values normally occur at the temperature extremes, additional noise immunity and guard banding can be achieved by decreasing the allowable system operating ranges.

Note 2: The specified limits shown in the DC Characteristics can be met only after thermal equilibrium has been established. Thermal equilibrium is established by applying power for at least 2 minutes while maintaining transverse air flow of 2.5 meters/s (500 linear feet/min) over the device either mounted in the test socket or on the printed circuit board. Test voltage values are given in the DC Operating Conditions and defined in Figure 4.

3

100175

DC Electrical Characteristics

$V_{EE} = -5.72V, V_{CC} = V_{CCA} = GND, T_A = 0^\circ C \text{ to } +75^\circ C$ (Notes 1, 2)

Symbol	Parameter	Temp	Min	Typ	Max	Units	Conditions
V _{OH}	Output HIGH Voltage	T _A = 0°C	-1000		-840	mV	V _{IN} = V _{IH} (Max) or V _{IL} (Min)
		T _A = +25°C	-960		-810	mV	
		T _A = +75°C	-900		-720	mV	
V _{OL}	Output LOW Voltage	T _A = 0°C	-1870		-1665	mV	V _{IN} = V _{IH} (Max) or V _{IL} (Min)
		T _A = +25°C	-1850		-1650	mV	
		T _A = +75°C	-1830		-1625	mV	
V _{OHC}	Output HIGH Voltage	T _A = 0°C	-1020			mV	V _{IN} = V _{IH} (Min) or V _{IL} (Max)
		T _A = +25°C	-980			mV	
		T _A = +75°C	-920			mV	
V _{OLC}	Output LOW Voltage	T _A = 0°C			-1645	mV	V _{IN} = V _{IH} (Min) or V _{IL} (Max)
		T _A = +25°C			-1630	mV	
		T _A = +75°C			-1605	mV	
V _{IH}	Input HIGH Voltage		-1165		-880	mV	Guaranteed HIGH Signal for All Inputs
V _{IL}	Input LOW Voltage		-1810		-1490	mV	Guaranteed LOW Signal for All Inputs
I _{IH}	Input HIGH Current				290	μA	V _{IN} = V _{IH} (Max)
I _{IL}	Input LOW Current		0.50			μA	V _{IN} = V _{IL} (Min)
I _{EE}	V _{EE} Supply Current		-125	-90	-50	mA	Inputs Open

Note 1: The specified limits represent the "worst case" value for the parameter. Since these "worst case" values normally occur at the temperature extremes, additional noise immunity and guard banding can be achieved by decreasing the allowable system operating ranges.

Note 2: The specified limits shown in the DC Characteristics can be met only after thermal equilibrium has been established. Thermal equilibrium is established by applying power for at least 2 minutes while maintaining transverse air flow of 2.5 meters/s (500 linear feet/min) over the device either mounted in the test socket or on the printed circuit board. Test voltage values are given in the DC Operating Conditions and defined in Figure 4.

AC Electrical Characteristics

$V_{EE} = -5.2V \pm 10\%, V_{CC} = V_{CCA} = GND$

Symbol	Parameter	T _A = 0°C		T _A = +25°C		T _A = +75°C		Units	Conditions
		Min	Max	Min	Max	Min	Max		
t _{PDH} t _{PDHL}	Propagation Delay Data to Output	1.10	2.60	1.10	2.75	1.10	3.00	ns	Figures 1 & 2
t _{PDH} t _{PDHL}	Propagation Delay Enable to Output	1.20	3.40	1.20	3.50	1.20	3.75	ns	Figures 1 & 3
t _{PDHL}	Propagation Delay Clear to Output	1.30	3.20	1.30	3.20	1.30	3.20	ns	Figures 1, 3 & 4
t _S	Setup Time D ₀ - D ₄		2.50		2.50		2.50	ns	Figures 1 & 5
t _H	Hold Time D ₀ - D ₄		0.50		0.50		0.50	ns	
t _{TLH} t _{THL}	Transition Time 20% to 80%, 80% to 20%	1.10	3.25	1.20	3.25	1.20	3.50	ns	Figures 1, 2, 3 & 4

[查询"100175DC"供应商](#)

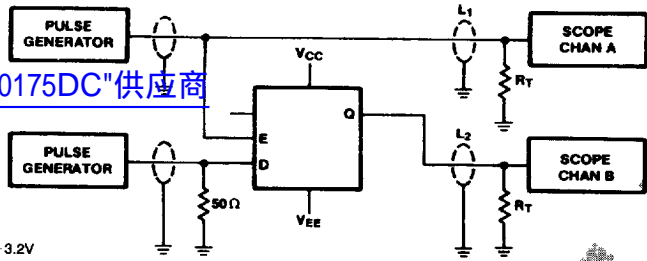

Notes:

- V_{CC}, V_{CCA} = +2V, V_{EE} = -3.2V
- L1 and L2 = equal length 50Ω impedance lines
- R_T = 50Ω terminator internal to scope
- Decoupling 0.1 μf from GND to V_{CC} and V_{EE}
- All unused outputs are loaded with 50Ω to GND
- C_L = Fixture and stray capacitance ≤ 3 pF

TL/F/9870-4

FIGURE 1. AC Test Circuit

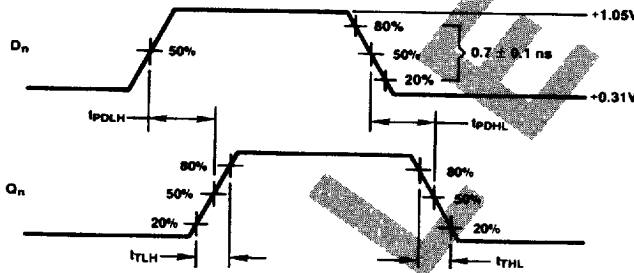

TL/F/9870-5

FIGURE 2. Data Propagation Delay @ T_A = +25°C

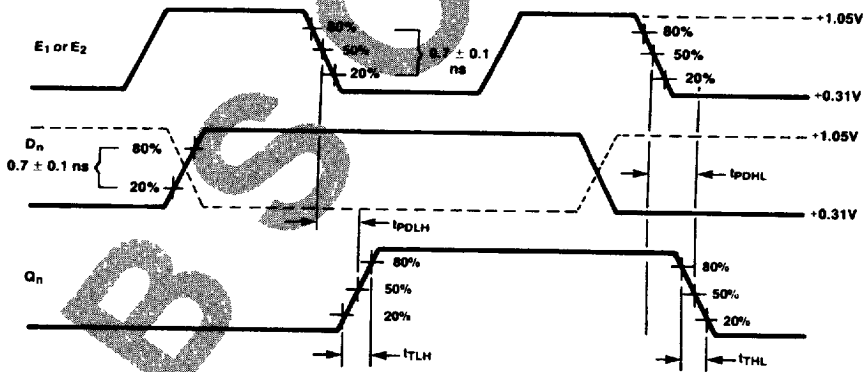

TL/F/9870-6

FIGURE 3. Enable Propagation Delay @ T_A = +25°C

100175

[查询"100175DC"供应商](#)

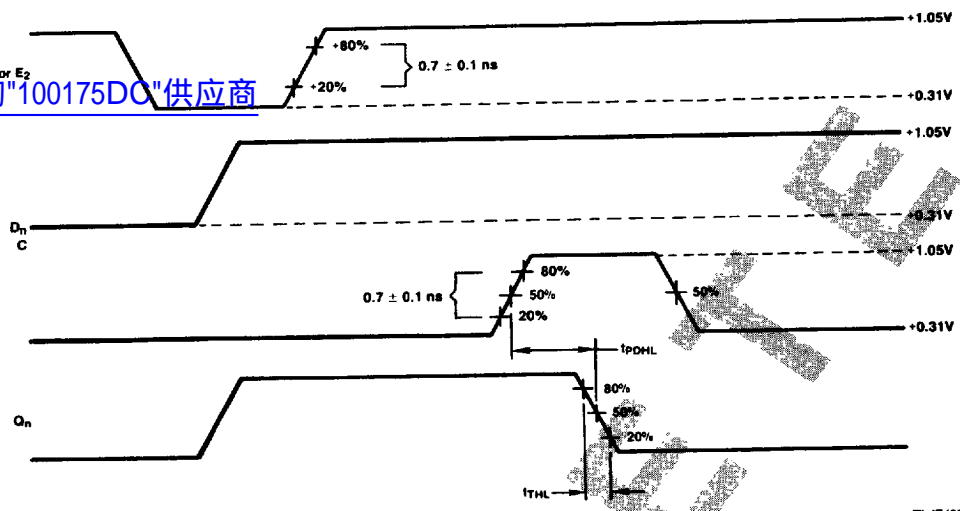

FIGURE 4. Clear Propagation Delay @ $T_A = +25^\circ\text{C}$

TL/F/9870-7

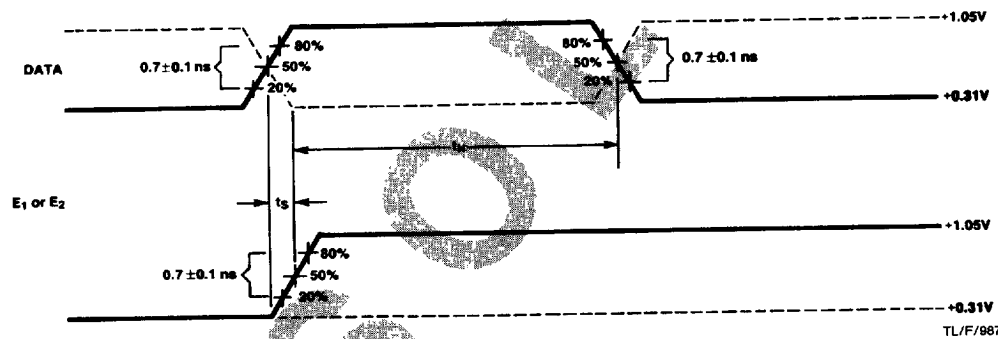

FIGURE 5. Data Setup and Hold Time

TL/F/9870-8