

LM9036

Ultra-Low Quiescent Current Voltage Regulator

General Description

The LM9036 ultra-low quiescent current regulator features low dropout voltage and low current in the standby mode. With less than 25µA Ground Pin current at a 0.1mA load, the LM9036 is ideally suited for automotive and other battery operated systems. The LM9036 retains all of the features that are common to low dropout regulators including a low dropout PNP pass device, short circuit protection, reverse battery protection, and thermal shutdown. The LM9036 has a 40V maximum operating voltage limit, a -40°C to +125°C operating temperature range, and ±5% output voltage tolerance over the entire output current, input voltage, and temperature range.

Features

- Ultra low Ground Pin current ($I_{GND} \leq 25\mu A$ for $I_{OUT} = 0.1mA$)
- Fixed 5V, 3.3V, 50mA output
- Output tolerance ±5% over line, load, and temperature
- Dropout voltage typically 200mV @ $I_{OUT} = 50mA$
- -45V reverse transient protection
- Internal short circuit current limit
- Internal thermal shutdown protection
- 40V operating voltage limit

Typical Application

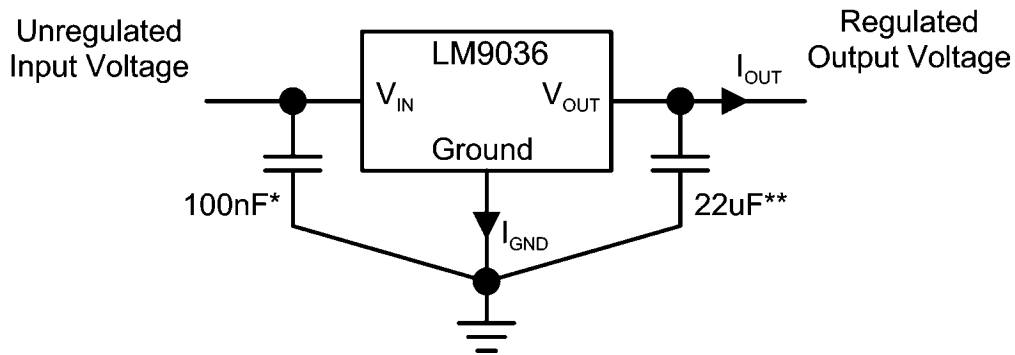

20001101

* Required if regulator is located more than 2 from power supply filter capacitor.

** Required for stability. Must be rated over intended operating temperature range. Effective series resistance (ESR) is critical, see Electrical Characteristics. Locate capacitor as close as possible to the regulator output and ground pins. Capacitance may be increased without bound.

Connection Diagrams

[查询"LM9036MX-3.3"供应商](#)

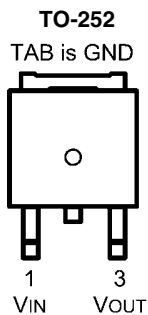

20001125

Top View

**Order Number LM9036DT-5.0, LM9036DTX-5.0,
LM9036DT-3.3, LM9036DTX-3.3
See NS Package Number TD03B**

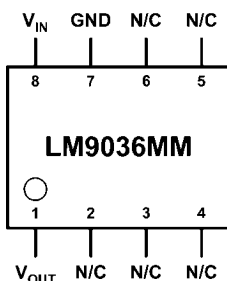

20001127

Top View

**LM9036MM-3.3, LM9036MMX-3.3, LM9036MM-5.0,
LM9036MMX-5.0
See NS Package Number MUA08A**

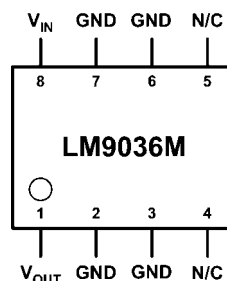

20001128

Top View

**LM9036M-3.3, LM9036MX-3.3, LM9036M-5.0, LM9036MX-5.0
See NS Package Number M08A**

Ordering Information

Output Voltage	Order	Package Type	Package Drawing	Transport Media
3.3V	LM9036M-3.3	8-Lead SOIC	M08A	Rail
	LM9036MX-3.3	8-Lead SOIC	M08A	Tape/Reel
	LM9036DT-3.3	TO-252	TD03B	Rail
	LM9036DTX-3.3	TO-252	TD03B	Tape/Reel
	LM9036MM-3.3	8-Lead Mini SOIC	MUA08A	Rail
	LM9036MMX-3.3	8-Lead Mini SOIC	MUA08A	Tape/Reel
5.0V	LM9036M-5.0	8-Lead SOIC	M08A	Rail
	LM9036MX-5.0	8-Lead SOIC	M08A	Tape/Reel
	LM9036DT-5.0	TO-252	TD03B	Rail
	LM9036DTX-5.0	TO-252	TD03B	Tape/Reel
	LM9036MM-5.0	8-Lead Mini SOIC	MUA08A	Rail
	LM9036MMX-5.0	8-Lead Mini SOIC	MUA08A	Tape/Reel

Absolute Maximum Ratings (Note 1)

查询"LM9036MX-3.3"供应商
If Military/Aerospace specified devices are required, please contact the National Semiconductor Sales Office/Distributors for availability and specifications.

Input Voltage (Survival)	+55V, -45V
ESD Susceptibility (Note 2)	±1.9kV
Power Dissipation (Note 3)	Internally limited
Junction Temperature (T_{Jmax})	150°C
Storage Temperature Range	-65°C to +150°C

Lead Temperature (Soldering, 10 sec.)

260°C

Operating Ratings

Operating Temperature Range	-40°C to +125°C
Maximum Input Voltage (Operational)	40V
SO-8 (M08A) θ_{JA} (Note 7)	140°C/W
TO-252 (TD03B) θ_{JA} (Note 7)	125°C/W
TO-252 (TD03B) θ_{JA} (Note 8)	50°C/W
TO-252 (TD03B) θ_{JC} (Note 7)	11°C/W
MSO-8 (MUA08A) θ_{JA} (Note 7)	200°C/W

Electrical Characteristics - LM9036-5.0

$V_{IN} = 14V$, $I_{OUT} = 10mA$, $T_J = 25°C$, unless otherwise specified. **Boldface** limits apply over entire operating temperature range

Parameter	Conditions	Min (Note 5)	Typical (Note 4)	Max (Note 5)	Units
Output Voltage (V_{OUT})		4.80	5.00	5.20	V
	$5.5V \leq V_{IN} \leq 26V$, $0.1mA \leq I_{OUT} \leq 50mA$ (Note 6)	4.75	5.00	5.25	
Quiescent Current (I_{GND})	$I_{OUT} = 0.1mA$, $8V \leq V_{IN} \leq 24V$		20	25	μA
	$I_{OUT} = 1mA$, $8V \leq V_{IN} \leq 24V$		50	100	
	$I_{OUT} = 10mA$, $8V \leq V_{IN} \leq 24V$		0.3	0.5	mA
	$I_{OUT} = 50mA$, $8V \leq V_{IN} \leq 24V$		2.0	2.5	
Line Regulation (ΔV_{OUT})	$6V \leq V_{IN} \leq 40V$, $I_{OUT} = 1mA$		10	30	mV
Load Regulation (ΔV_{OUT})	$0.1mA \leq I_{OUT} \leq 5mA$		10	30	mV
	$5mA \leq I_{OUT} \leq 50mA$		10	30	mV
Dropout Voltage (ΔV_{OUT})	$I_{OUT} = 0.1mA$		0.05	0.10	V
	$I_{OUT} = 50mA$		0.20	0.40	V
Short Circuit Current (I_{SC})	$V_{OUT} = 0V$	65	120	250	mA
Ripple Rejection (PSRR)	$V_{ripple} = 1V_{rms}$, $F_{ripple} = 120Hz$	-40	-60		dB
Output Bypass Capacitance (C_{OUT})	$0.3\Omega \leq ESR \leq 8\Omega$ $0.1mA \leq I_{OUT} \leq 50mA$	10	22		μF

Electrical Characteristics - LM9036-3.3

查询 LM9036MX-3.3 供应商

$V_{IN} = 14V$, $I_{OUT} = 10mA$, $T_J = 25^\circ C$, unless otherwise specified. **Boldface** limits apply over entire operating temperature range

Parameter	Conditions	Min (Note 5)	Typical (Note 4)	Max (Note 5)	Units
Output Voltage (V_{OUT})		3.168	3.30	3.432	V
	$5.5V \leq V_{IN} \leq 26V$, $0.1mA \leq I_{OUT} \leq 50mA$ (Note 6)	3.135	3.30	3.465	
Quiescent Current (I_{GND})	$I_{OUT} = 0.1mA$, $8V \leq V_{IN} \leq 24V$		20	25	μA
	$I_{OUT} = 1mA$, $8V \leq V_{IN} \leq 24V$		50	100	
	$I_{OUT} = 10mA$, $8V \leq V_{IN} \leq 24V$		0.3	0.5	mA
	$I_{OUT} = 50mA$, $8V \leq V_{IN} \leq 24V$		2.0	2.5	
Line Regulation (ΔV_{OUT})	$6V \leq V_{IN} \leq 40V$, $I_{OUT} = 1mA$		10	30	mV
Load Regulation (ΔV_{OUT})	$0.1mA \leq I_{OUT} \leq 5mA$		10	30	mV
	$5mA \leq I_{OUT} \leq 50mA$		10	30	mV
Dropout Voltage (ΔV_{OUT})	$I_{OUT} = 0.1mA$		0.05	0.10	V
	$I_{OUT} = 50mA$		0.20	0.40	V
Short Circuit Current (I_{SC})	$V_{OUT} = 0V$	65	120	250	mA
Ripple Rejection (PSRR)	$V_{ripple} = 1V_{rms}$, $F_{ripple} = 120Hz$	-40	-60		dB
Output Bypass Capacitance (C_{OUT})	$0.3\Omega \leq ESR \leq 8\Omega$	22	33		μF
	$0.1mA \leq I_{OUT} \leq 50mA$				

Note 1: Absolute Maximum Ratings indicate limits beyond which damage to the device may occur. DC and AC electrical specifications do not apply when operating the device beyond its specified operating ratings.

Note 2: Human body model, 100pF discharge through a 1.5k Ω resistor.

Note 3: The maximum power dissipation is a function of T_{Jmax} , θ_{JA} , and T_A . The maximum allowable power dissipation at any ambient temperature is $P_D = (T_{Jmax} - T_A)/\theta_{JA}$. If this dissipation is exceeded, the die temperature will rise above 150°C and the LM9036 will go into thermal shutdown.

Note 4: Typicals are at 25°C (unless otherwise specified) and represent the most likely parametric norm.

Note 5: Tested limits are guaranteed to National's AOQL (Average Outgoing Quality Level) and 100% tested.

Note 6: To ensure constant junction temperature, pulse testing is used.

Note 7: Worst case (Free Air) per EIA / JESD51-3.

Note 8: Typical θ_{JA} with 1 square inch of 2oz copper pad area directly under the ground tab.

Typical Performance Characteristics

[查询"LM9036MX-3.3"供应商](#)

Dropout Voltage

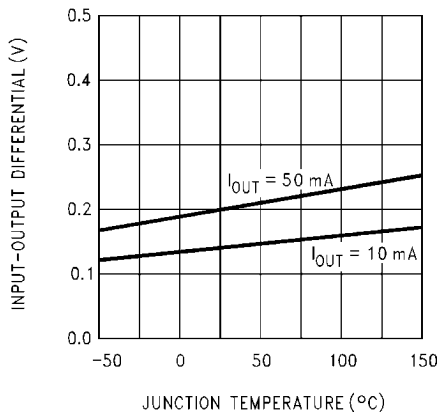

20001108

Quiescent Current

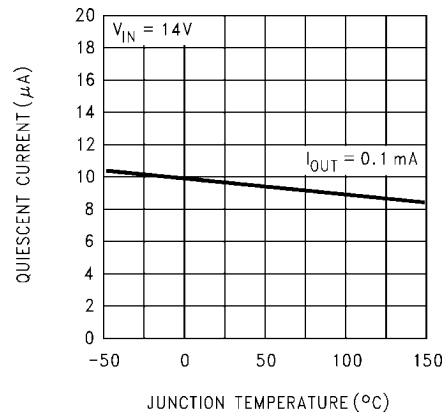

20001111

Quiescent Current

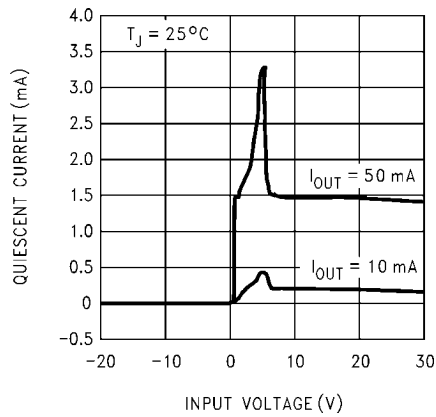

20001113

Quiescent Current

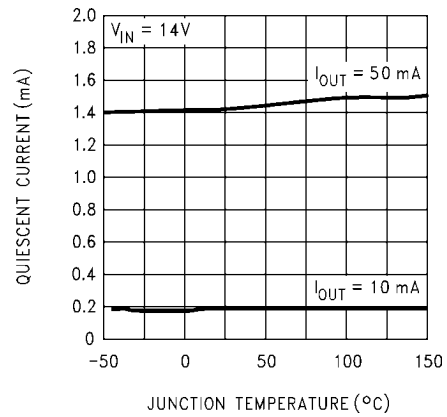

20001114

Peak Output Current

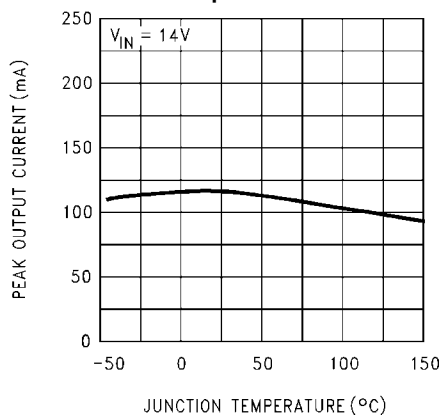

20001117

Applications Information

[查询"LM9036MX-3.3"供应商](#)

Unlike other PNP low dropout regulators, the LM9036 remains fully operational to 40V. Owing to power dissipation characteristics of the package, full output current cannot be guaranteed for all combinations of ambient temperature and input voltage.

The junction to ambient thermal resistance θ_{JA} rating has two distinct components: the junction to case thermal resistance rating θ_{JC} ; and the case to ambient thermal resistance rating θ_{CA} . The relationship is defined as: $\theta_{JA} = \theta_{JC} + \theta_{CA}$.

On the TO-252 package the ground tab is thermally connected to the backside of the die. Adding 1 square inch of 2 oz. copper pad area directly under the ground tab will improve the θ_{JA} rating to approximately 50°C/W.

While the LM9036 has an internally set thermal shutdown point of typically 150°C, this is intended as a safety feature only. Continuous operation near the thermal shutdown temperature should be avoided as it may have a negative affect on the life of the device.

Using the θ_{JA} for a LM9036DT mounted on a circuit board as defined at (Note 8), and using the formula for maximum allowable dissipation given in (Note 3) for an ambient temperature (T_A) of +85°C, we find that $P_{DMAX} = 1.3W$. Including the small contribution of the quiescent current I_Q to the total power dissipation, the maximum input voltage (while still delivering 50mA output current) is 29.5V. The LM9036DT will go into thermal shutdown when attempting to deliver the full output current of 50mA, with an ambient temperature of +85°C, and the input voltage is greater than 29.5V. Similarly, with an ambient temperature of 25°C the $P_{DMAX} = 2.5W$, and the LM9036DT can deliver the full output current of 50mA with an input voltage of up to 40V.

While the LM9036 maintains regulation to 55V, it will not withstand a short circuit above 40V because of safe operating area limitations in the internal PNP pass device. Above 55V the LM9036 will break down with catastrophic effects on the regulator and possibly the load as well. Do not use this device in a design where the input operating voltage may exceed 40V, or where transients are likely to exceed 55V.

Physical Dimensions inches (millimeters) unless otherwise noted

[查询"LM9036MX-3.3"供应商](#)

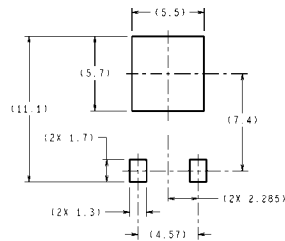

LAND PATTERN RECOMMENDATION

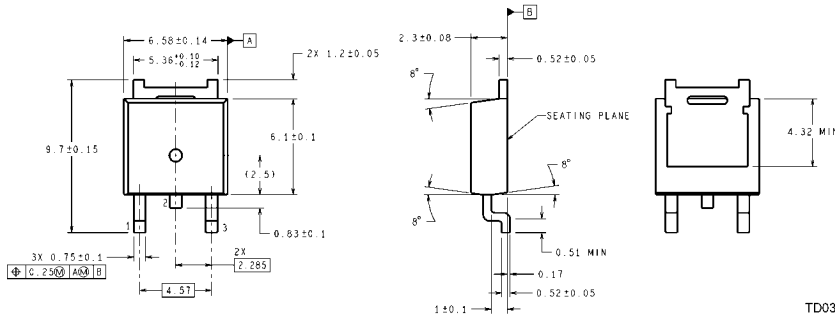

TD03B (Rev C)

**TO-252 Package (DT)
NS Package Number TD03B**

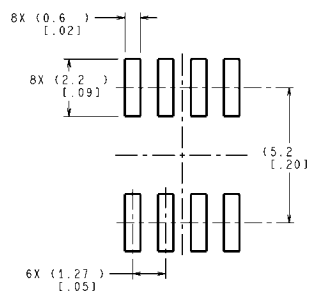
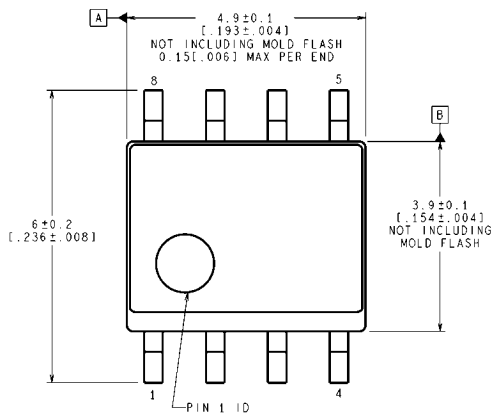

RECOMMENDED LAND PATTERN

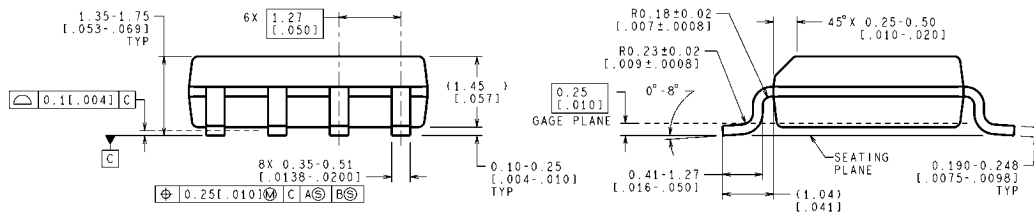

CONTROLLING DIMENSION IS MILLIMETER
VALUES IN [] ARE INCHES
DIMENSIONS IN () FOR REFERENCE ONLY

M08A (Rev L)

**8 Lead Small Outline Molded Package (M)
NS Package Number M08A**

查询"LM9036MX-3.3"供应商

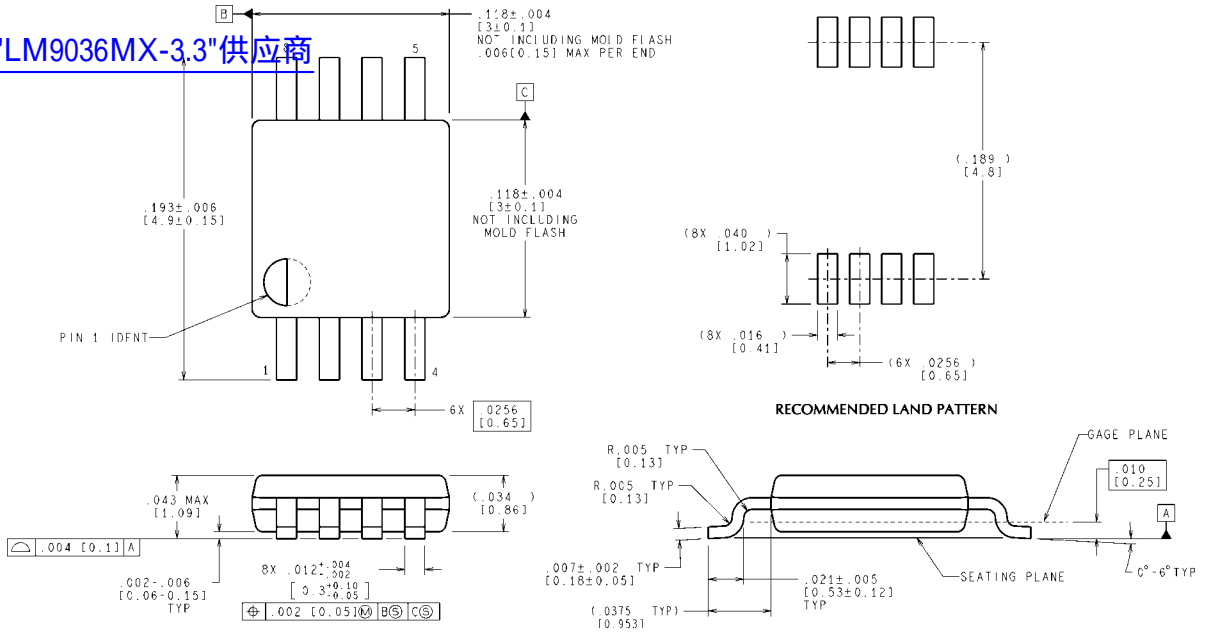

CONTROLLING DIMENSION IS INCH
 VALUES IN [] ARE MILLIMETERS

8 Lead Mini SOIC (MM)
NS Package Number MUA08A

MUA08A (Rev F)

[查询"LM9036MX-3.3"供应商](#)

Notes

[查询"LM9036MX-3.3"供应商](#)

Notes

For more National Semiconductor product information and proven design tools, visit the following Web sites at:

Products		Design Support	
Amplifiers	www.national.com/amplifiers	WEBENCH	www.national.com/webench
Audio	www.national.com/audio	Analog University	www.national.com/AU
Clock Conditioners	www.national.com/timing	App Notes	www.national.com/appnotes
Data Converters	www.national.com/adc	Distributors	www.national.com/contacts
Displays	www.national.com/displays	Green Compliance	www.national.com/quality/green
Ethernet	www.national.com/ethernet	Packaging	www.national.com/packaging
Interface	www.national.com/interface	Quality and Reliability	www.national.com/quality
LVDS	www.national.com/lvds	Reference Designs	www.national.com/refdesigns
Power Management	www.national.com/power	Feedback	www.national.com/feedback
Switching Regulators	www.national.com/switchers		
LDOs	www.national.com/lido		
LED Lighting	www.national.com/led		
PowerWise	www.national.com/powerwise		
Serial Digital Interface (SDI)	www.national.com/sdi		
Temperature Sensors	www.national.com/tempsensors		
Wireless (PLL/VCO)	www.national.com/wireless		

THE CONTENTS OF THIS DOCUMENT ARE PROVIDED IN CONNECTION WITH NATIONAL SEMICONDUCTOR CORPORATION ("NATIONAL") PRODUCTS. NATIONAL MAKES NO REPRESENTATIONS OR WARRANTIES WITH RESPECT TO THE ACCURACY OR COMPLETENESS OF THE CONTENTS OF THIS PUBLICATION AND RESERVES THE RIGHT TO MAKE CHANGES TO SPECIFICATIONS AND PRODUCT DESCRIPTIONS AT ANY TIME WITHOUT NOTICE. NO LICENSE, WHETHER EXPRESS, IMPLIED, ARISING BY ESTOPPEL OR OTHERWISE, TO ANY INTELLECTUAL PROPERTY RIGHTS IS GRANTED BY THIS DOCUMENT.

TESTING AND OTHER QUALITY CONTROLS ARE USED TO THE EXTENT NATIONAL DEEMS NECESSARY TO SUPPORT NATIONAL'S PRODUCT WARRANTY. EXCEPT WHERE MANDATED BY GOVERNMENT REQUIREMENTS, TESTING OF ALL PARAMETERS OF EACH PRODUCT IS NOT NECESSARILY PERFORMED. NATIONAL ASSUMES NO LIABILITY FOR APPLICATIONS ASSISTANCE OR BUYER PRODUCT DESIGN. BUYERS ARE RESPONSIBLE FOR THEIR PRODUCTS AND APPLICATIONS USING NATIONAL COMPONENTS. PRIOR TO USING OR DISTRIBUTING ANY PRODUCTS THAT INCLUDE NATIONAL COMPONENTS, BUYERS SHOULD PROVIDE ADEQUATE DESIGN, TESTING AND OPERATING SAFEGUARDS.

EXCEPT AS PROVIDED IN NATIONAL'S TERMS AND CONDITIONS OF SALE FOR SUCH PRODUCTS, NATIONAL ASSUMES NO LIABILITY WHATSOEVER, AND NATIONAL DISCLAIMS ANY EXPRESS OR IMPLIED WARRANTY RELATING TO THE SALE AND/OR USE OF NATIONAL PRODUCTS INCLUDING LIABILITY OR WARRANTIES RELATING TO FITNESS FOR A PARTICULAR PURPOSE, MERCHANTABILITY, OR INFRINGEMENT OF ANY PATENT, COPYRIGHT OR OTHER INTELLECTUAL PROPERTY RIGHT.

LIFE SUPPORT POLICY

NATIONAL'S PRODUCTS ARE NOT AUTHORIZED FOR USE AS CRITICAL COMPONENTS IN LIFE SUPPORT DEVICES OR SYSTEMS WITHOUT THE EXPRESS PRIOR WRITTEN APPROVAL OF THE CHIEF EXECUTIVE OFFICER AND GENERAL COUNSEL OF NATIONAL SEMICONDUCTOR CORPORATION. As used herein:

Life support devices or systems are devices which (a) are intended for surgical implant into the body, or (b) support or sustain life and whose failure to perform when properly used in accordance with instructions for use provided in the labeling can be reasonably expected to result in a significant injury to the user. A critical component is any component in a life support device or system whose failure to perform can be reasonably expected to cause the failure of the life support device or system or to affect its safety or effectiveness.

National Semiconductor and the National Semiconductor logo are registered trademarks of National Semiconductor Corporation. All other brand or product names may be trademarks or registered trademarks of their respective holders.

Copyright© 2008 National Semiconductor Corporation

For the most current product information visit us at www.national.com



**National Semiconductor
Americas Technical
Support Center**
Email: support@nsc.com
Tel: 1-800-272-9959

**National Semiconductor Europe
Technical Support Center**
Email: europe.support@nsc.com
German Tel: +49 (0) 180 5010 771
English Tel: +44 (0) 870 850 4288

**National Semiconductor Asia
Pacific Technical Support Center**
Email: ap.support@nsc.com

**National Semiconductor Japan
Technical Support Center**
Email: jpn.feedback@nsc.com