



KSP2907A

PNP General Purpose Amplifier

Features

- Collector-Emitter Voltage: $V_{CE0} = 60V$
- Collector Power Dissipation: $P_c (max) = 625mW$
- Suffix "-C" means a Center Collector (1. Emitter 2. Collector 3. Base)
- Non suffix "-C" means a Side Collector (1. Emitter 2. Base 3. Collector)
- Available as PN2907A

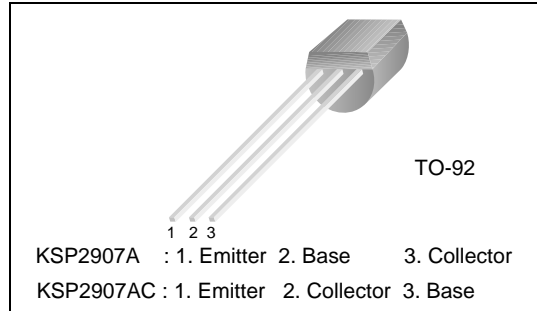

Absolute Maximum Ratings * $T_a = 25^\circ C$ unless otherwise noted

Symbol	Parameter	Value	Units
V_{CBO}	Collector-Base Voltage	-60	V
V_{CEO}	Collector-Emitter Voltage	-60	V
V_{EBO}	Emitter-Base Voltage	-5	V
I_C	Collector current	-600	mA
T_J	Junction Temperature	+150	$^\circ C$
T_{stg}	Storage Temperature	-55 ~ +150	$^\circ C$

* 1. These ratings are limiting values above which the serviceability of any semiconductor device may be impaired.
2. These are steady state limits. The factory should be consulted on applications involving pulsed or low duty cycle operations.

Thermal Characteristics $T_a = 25^\circ C$ unless otherwise noted

Symbol	Parameter	Max	Units
P_C	Collector Power Dissipation, by $R_{\theta JA}$	625	mW
$R_{\theta JC}$	Thermal Resistance, Junction to Case(note1)	83.3	$^\circ C/W$
$R_{\theta JA}$	Thermal Resistance, Junction to Ambient(note2)	200	$^\circ C/W$

Note1. Infinite heat sink.
Note2. Minimum Land pad size.

Electrical Characteristics * $T_a = 25^\circ C$ unless otherwise noted

Symbol	Parameter	Test Condition	Min.	Typ.	Max.	Units
$V_{(BR)CBO}$	Collector-Base Breakdown Voltage	$I_C = -10\mu A, I_E = 0$	-60			V
$V_{(BR)CEO}$	Collector-Emitter Breakdown Voltage	$I_C = -10mA, I_B = 0$	-60			V
$V_{(BR)EBO}$	Emitter-Base Breakdown Voltage	$I_E = -10\mu A, I_C = 0$	-5.0			V
I_{CBO}	Collector Cutoff Current	$V_{CB} = -50V, I_E = 0$			-10	nA
h_{FE}	DC Current Gain	$V_{CE} = -10V, I_C = -0.1mA,$ $V_{CE} = -10V, I_C = -1mA,$ $V_{CE} = -10V, I_C = -10mA,$ $V_{CE} = -10V, I_C = -150mA,$ $V_{CE} = -10V, I_C = -500mA,$	75 100 100 100 50		300	
$V_{CE(sat)}$	Collector-Emitter Saturation Voltage	$I_C = -150mA, I_B = -15mA$ $I_C = -500mA, I_B = -50mA$			-0.4 -1.6	V V
$V_{BE(sat)}$	Base-Emitter Saturation Voltage	$I_C = -150mA, I_B = -15mA$ $I_C = -500mA, I_B = -50mA$			-1.3 -2.6	V V
C_{obo}	Output Capacitance	$V_{CB} = -10V, I_E = 0, f = 1.0MHz$			8	pF
f_T	Current Gain Bandwidth Product	$I_C = -50mA, V_{CE} = -20V,$ $f = 100MHz$	200			MHz
t_{ON}	Turn On Time	$V_{CC} = -30V, I_C = -150mA, I_{B1} = -15mA$			45	ns
t_{OFF}	Turn Off Time	$V_{CC} = -6V, I_C = -150mA, I_{B1} = -15mA$			100	ns

* DC Item are tested by Pulse Test: Pulse Width $\leq 300\mu s$, Duty Cycle $\leq 2\%$

Package Marking and Ordering Information

Device ^(note)	Device Marking	Package	Packing Method	Qty(pcs)	Pin Definitions
KSP2907ABU	KSP2907A	TO-92	BULK	--	1.Emitter 2.Base 3.Collector
KSP2907ACBU	KSP2907AC	TO-92	BULK	--	1.Emitter 2.Collector 3.Base
KSP2907ATA	KSP2907A	TO-92	TAPE & AMMO	2,000	1.Emitter 2.Base 3.Collector
KSP2907ACTA	KSP2907AC	TO-92	TAPE & AMMO	2,000	1.Emitter 2.Collector 3.Base
KSP2907ATF	KSP2907A	TO-92	TAPE & REEL	2,000	1.Emitter 2.Base 3.Collector

Note : Affix "-C-" - center collector pin.
Suffix "-BU" - Bulk packing, straight lead form.(see package dimensions)
Suffix "-TF" - Tape& Reel packing, 0.200 In-Line Spacing lead form. (see package dimensions)
Suffix "-TA" - Tape& AMMO packing, 0.200 In-Line Spacing lead form. (see package dimensions)

Typical Characteristics

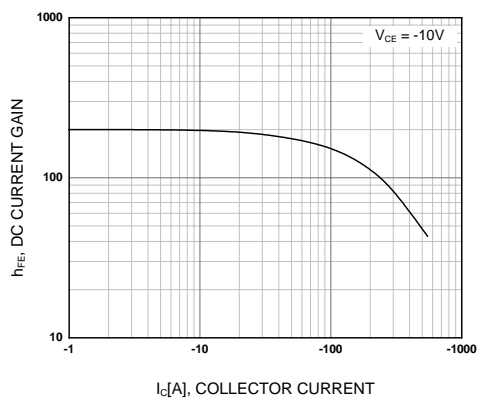

Figure 1. DC current Gain

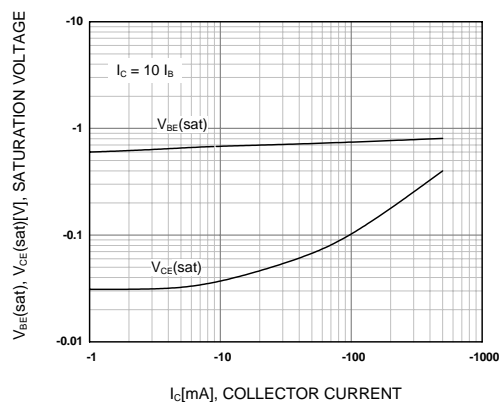

Figure 2. Collector-Emitter Saturation Voltage
Base-Emitter Saturation Voltage

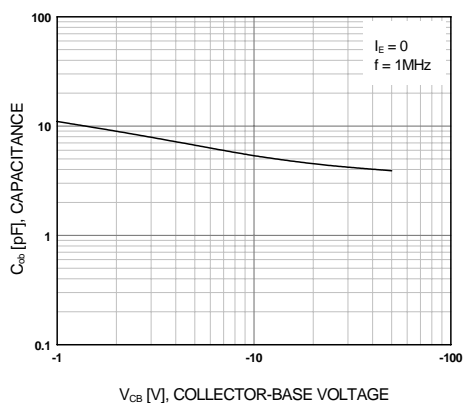

Figure 3. Output Capacitance

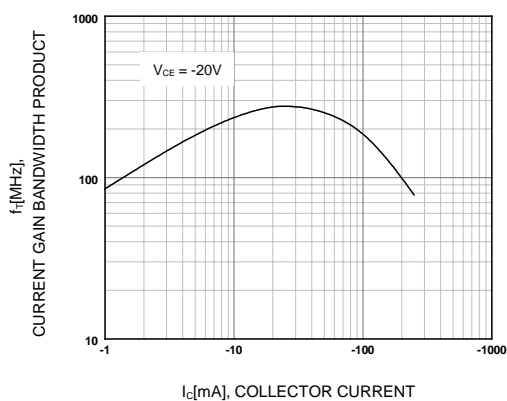
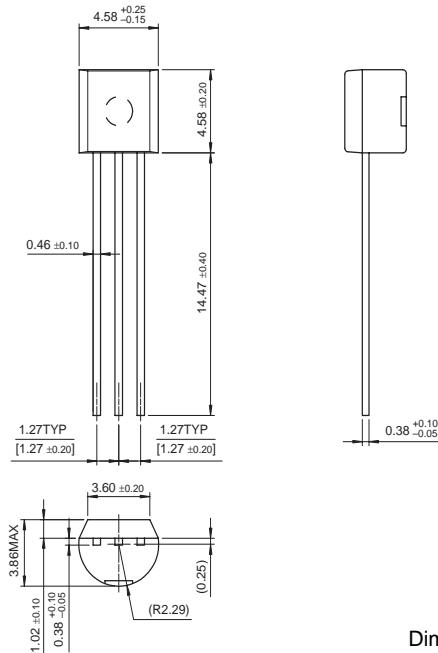

Figure 4. Current Gain Bandwidth Product

Package Dimensions

TO-92 Straight Lead Form



Dimensions in Millimeters

TO-92 0.200 In-Line Spacing Lead Form

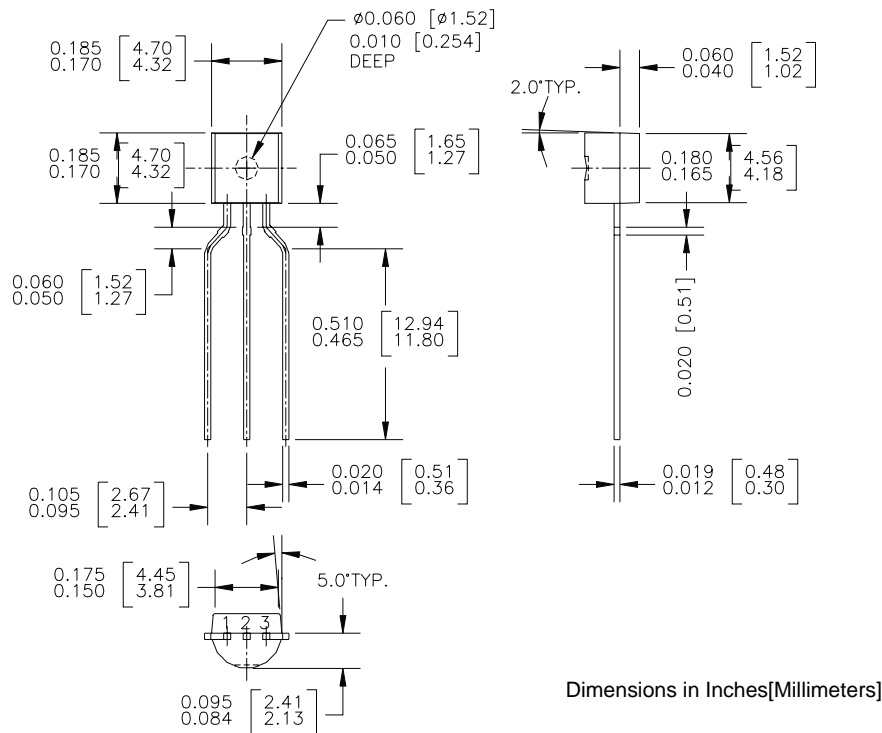

Dimensions in Inches[Millimeters]

TRADEMARKS

The following are registered and unregistered trademarks Fairchild Semiconductor owns or is authorized to use and is not intended to be an exhaustive list of all such trademarks.

ACEx™	FACT Quiet Series™	OCX™	SILENT SWITCHER®	UltraFET®
ActiveArray™	GlobalOptoisolator™	OCXPro™	SMART START™	UniFET™
Bottomless™	GTO™	OPTOLOGIC®	SPM™	VCX™
Build it Now™	HiSeC™	OPTOPLANAR™	Stealth™	Wire™
CoolFET™	l ² C™	PACMAN™	SuperFET™	
CROSSVOLT™	i-Lo™	POP™	SuperSOT™-3	
DOMETM	ImpliedDisconnect™	Power247™	SuperSOT™-6	
EcoSPARK™	IntelliMAX™	PowerEdge™	SuperSOT™-8	
E ² CMOS™	ISOPLANAR™	PowerSaver™	SyncFET™	
EnSigna™	LittleFET™	PowerTrench®	TCM™	
FACT™	MICROCOUPLER™	QFET®	TinyBoost™	
FAST®	MicroFET™	QS™	TinyBuck™	
FASTr™	MicroPak™	QT Optoelectronics™	TinyPWM™	
FPS™	MICROWIRE™	Quiet Series™	TinyPower™	
FRFET™	MSX™	RapidConfigure™	TinyLogic®	
	MSXPro™	RapidConnect™	TINYOPTO™	
Across the board. Around the world.™		μSerDes™	TruTranslation™	
The Power Franchise®		ScalarPump™	UHC™	
Programmable Active Droop™				

DISCLAIMER

FAIRCHILD SEMICONDUCTOR RESERVES THE RIGHT TO MAKE CHANGES WITHOUT FURTHER NOTICE TO ANY PRODUCTS HEREIN TO IMPROVE RELIABILITY, FUNCTION OR DESIGN. FAIRCHILD DOES NOT ASSUME ANY LIABILITY ARISING OUT OF THE APPLICATION OR USE OF ANY PRODUCT OR CIRCUIT DESCRIBED HEREIN; NEITHER DOES IT CONVEY ANY LICENSE UNDER ITS PATENT RIGHTS, NOR THE RIGHTS OF OTHERS. THESE SPECIFICATIONS DO NOT EXPAND THE TERMS OF FAIRCHILD'S WORLDWIDE TERMS AND CONDITIONS, SPECIFICALLY THE WARRANTY THEREIN, WHICH COVERS THESE PRODUCTS.

LIFE SUPPORT POLICY

FAIRCHILD'S PRODUCTS ARE NOT AUTHORIZED FOR USE AS CRITICAL COMPONENTS IN LIFE SUPPORT DEVICES OR SYSTEMS WITHOUT THE EXPRESS WRITTEN APPROVAL OF FAIRCHILD SEMICONDUCTOR CORPORATION.

As used herein:

- Life support devices or systems are devices or systems which, (a) are intended for surgical implant into the body, or (b) support or sustain life, or (c) whose failure to perform when properly used in accordance with instructions for use provided in the labeling, can be reasonably expected to result in significant injury to the user.
- A critical component is any component of a life support device or system whose failure to perform can be reasonably expected to cause the failure of the life support device or system, or to affect its safety or effectiveness.

PRODUCT STATUS DEFINITIONS

Definition of Terms

Datasheet Identification	Product Status	Definition
Advance Information	Formative or In Design	This datasheet contains the design specifications for product development. Specifications may change in any manner without notice.
Preliminary	First Production	This datasheet contains preliminary data, and supplementary data will be published at a later date. Fairchild Semiconductor reserves the right to make changes at any time without notice in order to improve design.
No Identification Needed	Full Production	This datasheet contains final specifications. Fairchild Semiconductor reserves the right to make changes at any time without notice in order to improve design.
Obsolete	Not In Production	This datasheet contains specifications on a product that has been discontinued by Fairchild semiconductor. The datasheet is printed for reference information only.

Rev. I20