

Technical Data Sheet

Mini TOP View LEDs

65-21SYGC/S530-XX/TR8

Features

- White SMT package.
- Optical indicator.
- Wide viewing angle.
- Soldering methods: reflow soldering
- Available on tape and reel
- Pb-free
- The product itself will remain within RoHS compliant version.

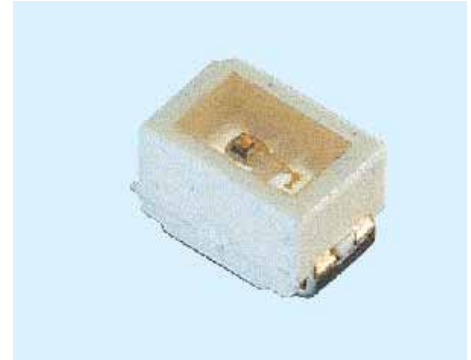

Descriptions

- The 65-21 series is available in soft orange, green, blue, and yellow. Due to the package design, the LED has wide viewing angle and optimized light coupling by inter reflector. This feature makes it ideal for light pipe application.

Applications

- Optical indicators.
- Coupling into light guides.
- Backlighting (LCD, cellular phones, switches, keys, displays, illuminated advertising, general lighting).
- Coupling into light guides; Interior automotive lighting (e.g. dashboard backlighting, etc.).

Device Selection Guide

Chip		Lens Color
Material	Emitted Color	
AlGaInP	Brilliant Yellow Green	Water Clear

65-21SYGC/S530-XX/TR8

Package Outline Dimensions

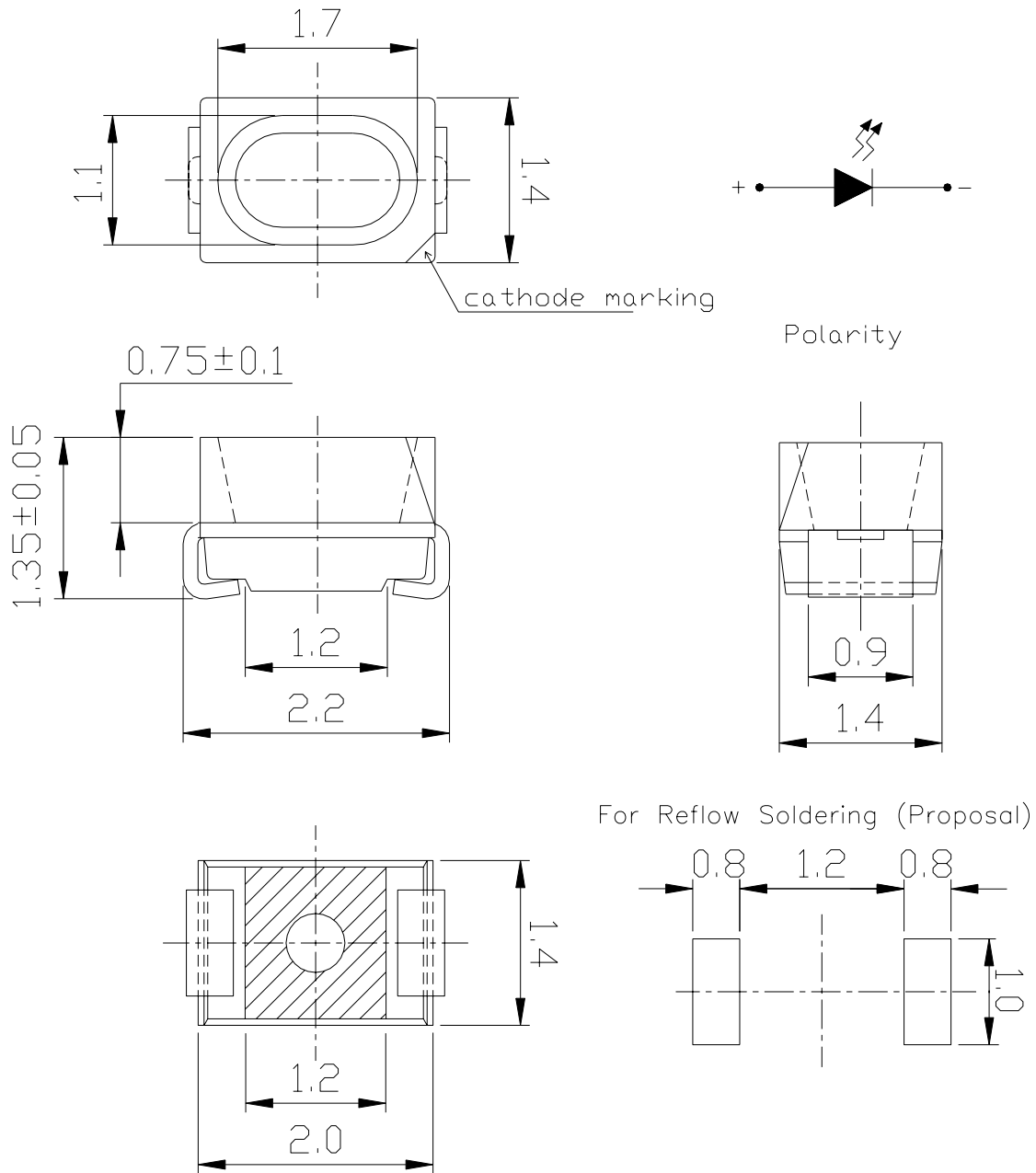

Notes: All dimensions are in millimeters.
Tolerances unspecified are ±0.1mm.

65-21SYGC/S530-XX/TR8
Absolute Maximum Ratings (Ta=25°C)

Parameter	Symbol	Rating	Unit
Reverse Voltage	V _R	5	V
Forward Current	I _F	25	mA
Operating Temperature	T _{opr}	-40 ~ +85	°C
Storage Temperature	T _{stg}	-40 ~ +90	°C
Electrostatic Discharge(HBM)	ESD	2000	V
Power Dissipation	P _d	60	mW
Peak Forward Current (Duty 1/10 @1KHz)	I _{FP}	60	mA
Soldering Temperature	T _{sol}	Reflow Soldering : 260 °C for 10 sec. Hand Soldering : 350 °C for 3 sec.	

65-21SYGC/S530-XX/TR8
Electro-Optical Characteristics (Ta=25°C)

Parameter	Symbol	*Chip Rank	Min.	Typ.	Max.	Unit	Condition
Luminous Intensity	Iv	E2	14.5	20	-----	mcd	IF=20mA
		E3	32	46	-----		
		E4	40	60	-----		
		E5	50	75	-----		
Viewing Angle	2θ 1/2	-----	-----	120	-----	deg	IF=20mA
Peak Wavelength	λp	-----	-----	575	-----	nm	IF=20mA
Dominant Wavelength	λd	-----	-----	573	-----	nm	IF=20mA
Spectrum Radiation Bandwidth	Δλ	-----	-----	20	-----	nm	IF=20mA
Forward Voltage	VF	-----	-----	2.0	2.4	V	IF=20mA
Reverse Current	IR	-----	-----	-----	10	μA	VR=5V

*65-21SYGC/S530-XX/TR8

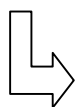

Chip Rank

65-21SYGC/S530-XX/TR8

Typical Electro-Optical Characteristics Curves

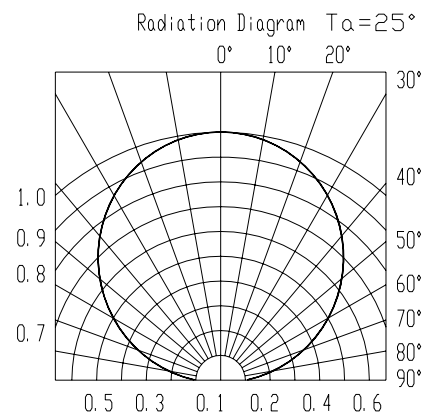
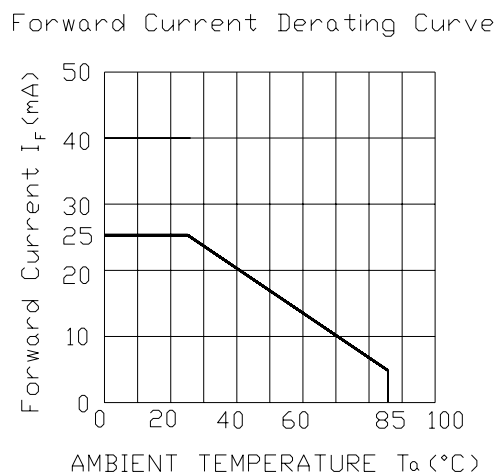
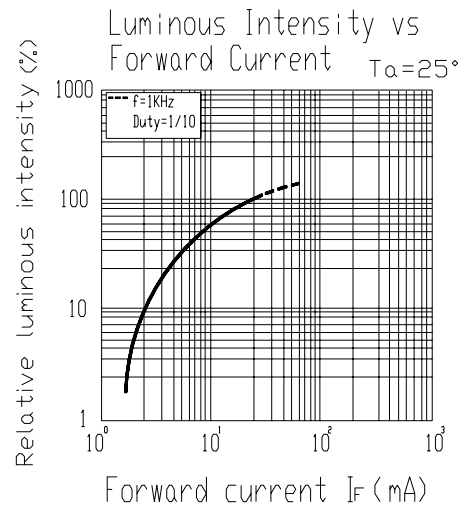
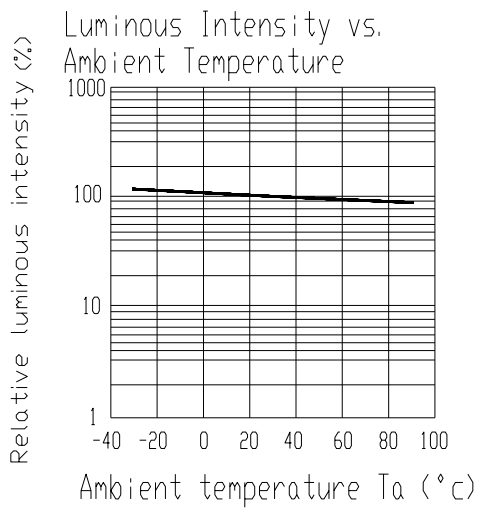
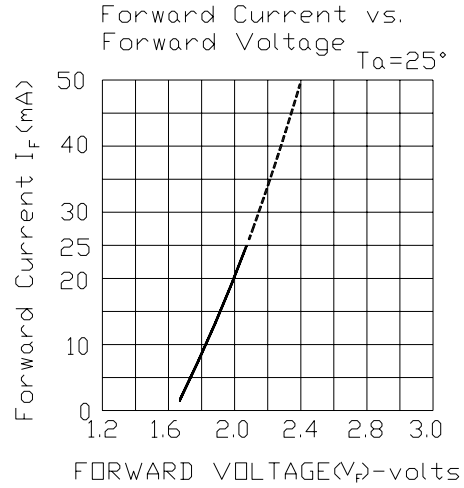
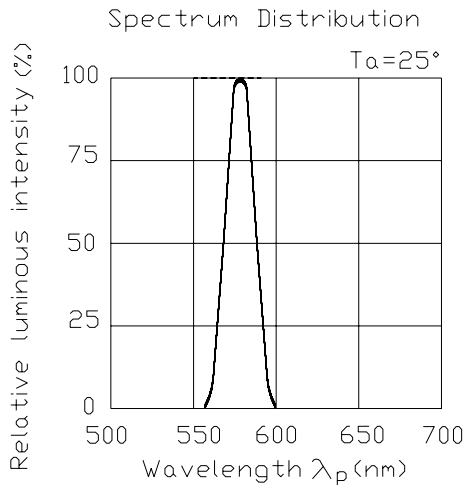

65-21SYGC/S530-XX/TR8

Label explanation

CAT: Luminous Intensity Rank

HUE: Dom. Wavelength Rank

REF: Forward Voltage Rank

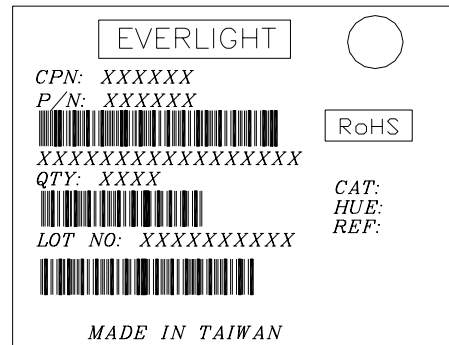

Reel Dimensions

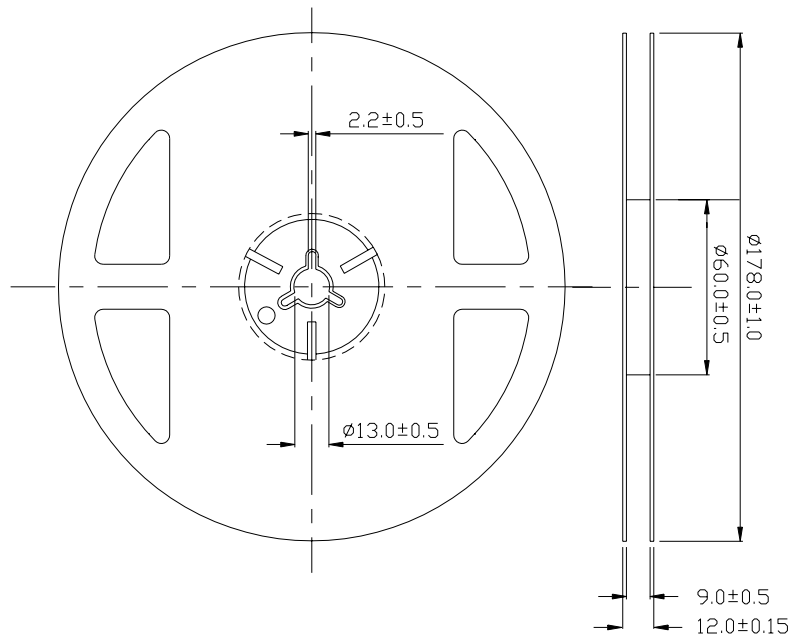

Note: The tolerances unless mentioned is $\pm 0.1\text{mm}$,Unit = mm

65-21SYGC/S530-XX/TR8

Carrier Tape Dimensions: Loaded quantity 3000 PCS per reel.

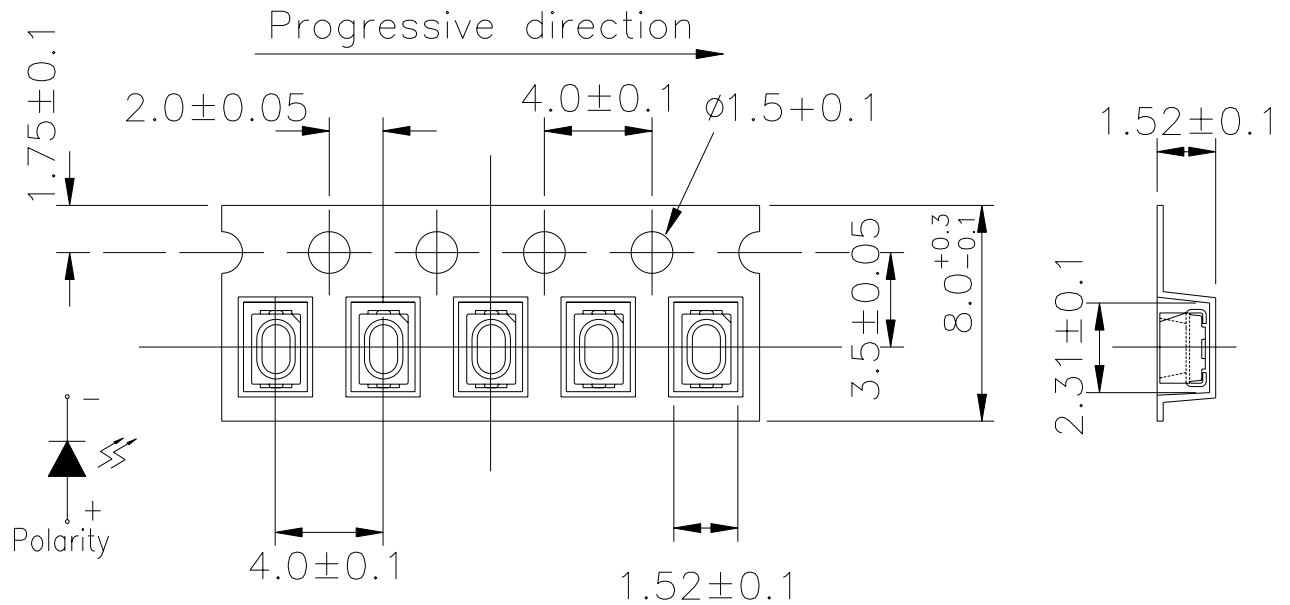

Note: The tolerances unless mentioned is $\pm 0.1\text{mm}$, Unit = mm

Moisture Resistant Packaging

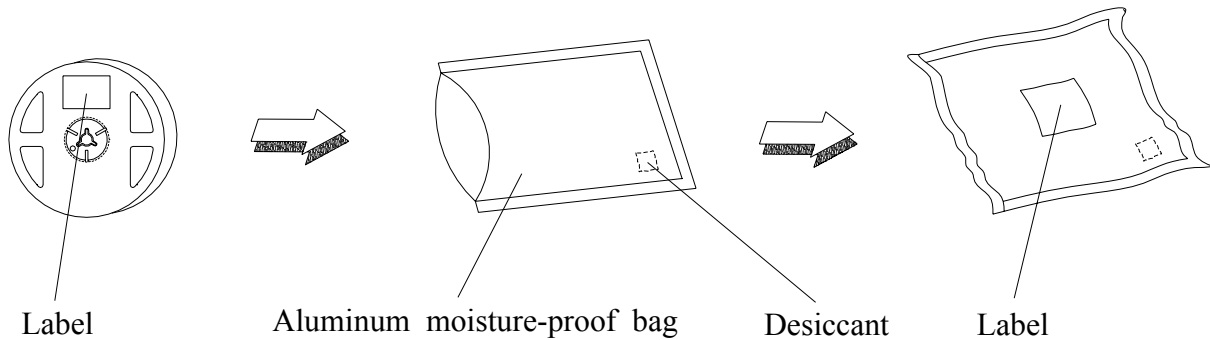

65-21SYGC/S530-XX/TR8
Reliability Test Items And Conditions

The reliability of products shall be satisfied with items listed below.

Confidence level : 90%

LTPD : 10%

No.	Items	Test Condition	Test Hours/Cycles	Sample Size	Ac/Re
1	Reflow Soldering	Temp. : 260°C±5°C Min. 5sec.	6 Min.	22 PCS.	0/1
2	Temperature Cycle	H : +100°C 15min ∫ 5 min L : -40°C 15min	300 Cycles	22 PCS.	0/1
3	Thermal Shock	H : +100°C 5min ∫ 10 sec L : -10°C 5min	300 Cycles	22 PCS.	0/1
4	High Temperature Storage	Temp. : 100°C	1000 Hrs.	22 PCS.	0/1
5	Low Temperature Storage	Temp. : -40°C	1000 Hrs.	22 PCS.	0/1
6	DC Operating Life	IF = 20 mA	1000 Hrs.	22 PCS.	0/1
7	High Temperature / High Humidity	85°C / 85%RH	1000 Hrs.	22 PCS.	0/1

65-21SYGC/S530-XX/TR8**Precautions For Use**

1. Over-current-proof

Customer must apply resistors for protection, otherwise slight voltage shift will cause big current change (Burn out will happen).

2. Storage

2.1 Do not open moisture proof bag before the products are ready to use.

2.2 Before opening the package: The LEDs should be kept at 30°C or less and 90%RH or less.

2.3 After opening the package: The LED's floor life is 1 year under 30 deg C or less and 60% RH or less.

If unused LEDs remain, it should be stored in moisture proof packages.

2.4 If the moisture absorbent material (silica gel) has faded away or the LEDs have exceeded the storage time, baking treatment should be performed using the following conditions.

Baking treatment : 60±5°C for 24 hours.

3. Soldering Condition

3.1 Pb-free solder temperature profile

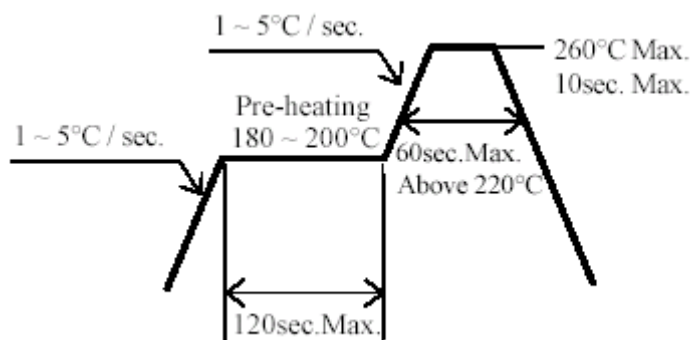

3.2 Reflow soldering should not be done more than two times.

3.3 When soldering, do not put stress on the LEDs during heating.

3.4 After soldering, do not warp the circuit board.

4. Soldering Iron

Each terminal is to go to the tip of soldering iron temperature less than 350°C for 3 seconds within once in less than the soldering iron capacity 25W. Leave two seconds and more intervals, and do soldering of each terminal. Be careful because the damage of the product is often started at the time of the hand solder.

5.Repairing

Repair should not be done after the LEDs have been soldered. When repairing is unavoidable, a double-head soldering iron should be used (as below figure). It should be confirmed beforehand whether the characteristics of the LEDs will or will not be damaged by repairing.

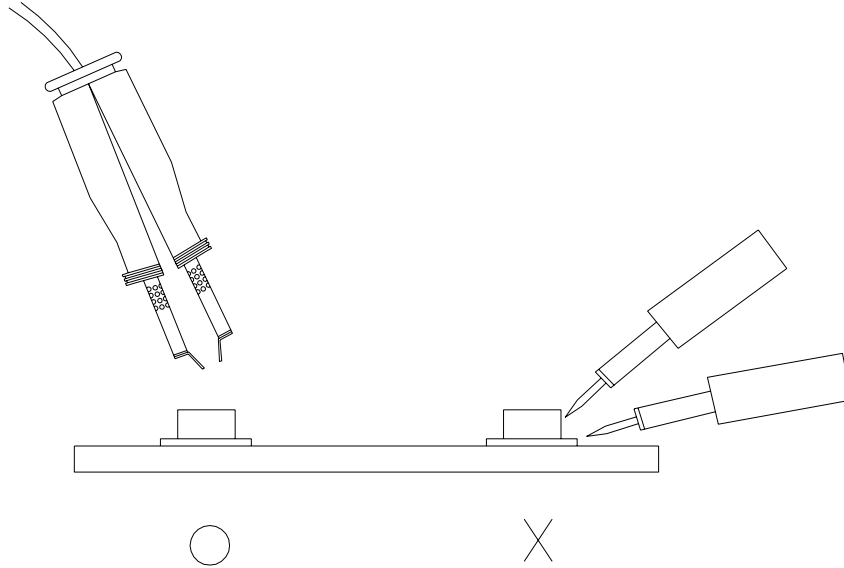

EVERLIGHT ELECTRONICS CO., LTD.
Office: No 25, Lane 76, Sec 3, Chung Yang Rd,
Tucheng, Taipei 236, Taiwan, R.O.C

Tel: 886-2-2267-2000, 2267-9936
Fax: 886-2267-6244, 2267-6189, 2267-6306
<http://www.everlight.com>