

N-Channel Logic Level Enhancement Mode Field Effect Transistor

PRODUCT SUMMARY		
V _{DSS}	I _D	R _{DS(ON)} (mΩ) Max
30V	42A	10 @ V _{GS} = 10V
		16 @ V _{GS} = 4.5V

FEATURES

- Super high dense cell design for low R_{DS(ON)}.
- Rugged and reliable.
- TO-252 and TO-251 Package.

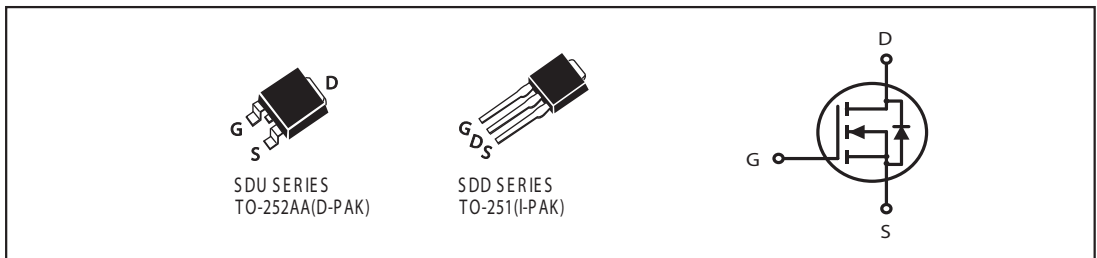

ABSOLUTE MAXIMUM RATINGS (T_C=25°C unless otherwise noted)

Parameter	Symbol	Limit	Unit
Drain-Source Voltage	V _{DS}	30	V
Gate-Source Voltage	V _{GS}	±20	V
Drain Current-Continuous @ T _J =125°C -Pulsed ^a	I _D	42	A
	I _{DM}	105	A
Drain-Source Diode Forward Current	I _S	40	A
Maximum Power Dissipation @ T _C =25°C	P _D	50	W
Operating and Storage Temperature Range	T _J , T _{STG}	-55 to 175	°C

THERMAL CHARACTERISTICS

Thermal Resistance, Junction-to-Case	R _{θJC}	3	°C/W
Thermal Resistance, Junction-to-Ambient	R _{θJA}	50	°C/W

SDU/D40N03L

查询"SDU/D40N03L"供应商

ELECTRICAL CHARACTERISTICS (T_c=25°C unless otherwise noted)

Parameter	Symbol	Condition	Min	Typ	Max	Unit
OFF CHARACTERISTICS						
Drain-Source Breakdown Voltage	BV _{DSS}	V _{GS} = 0V, I _D = 250uA	30			V
Zero Gate Voltage Drain Current	I _{DSS}	V _{DS} = 24V, V _{GS} = 0V			10	uA
Gate-Body Leakage	I _{GSS}	V _{GS} = ±20V, V _{DS} = 0V			±100	nA
ON CHARACTERISTICS^a						
Gate Threshold Voltage	V _{GS(th)}	V _{DS} = V _{GS} , I _D = 250uA	1	1.5	3	V
Drain-Source On-State Resistance	R _{DS(ON)}	V _{GS} = 10V, I _D = 20A		9	10	m ohm
		V _{GS} = 4.5V, I _D = 10A		13	16	m ohm
On-State Drain Current	I _{D(ON)}	V _{DS} = 10V, V _{GS} = 10V	40			A
Forward Transconductance	g _{FS}	V _{DS} = 10V, I _D = 20A		30		S
DYNAMIC CHARACTERISTICS^b						
Input Capacitance	C _{ISS}	V _{DD} = 15V, V _{GS} = 0V f = 1.0MHz		1375		pF
Output Capacitance	C _{OSS}			670		pF
Reverse Transfer Capacitance	C _{RSS}			200		pF
SWITCHING CHARACTERISTICS^b						
Turn-On Delay Time	t _{D(ON)}	V _{DD} = 15V I _D = 1A V _{GS} = 10V R _{GEN} = 6 ohm		30		ns
Rise Time	t _r			32		ns
Turn-Off Delay Time	t _{D(OFF)}			132		ns
Fall time	t _f			30		ns
Total Gate Charge	Q _g	V _{DS} = 10V, I _D = 40A, V _{GS} = 10V		40		nC
		V _{DS} = 10V, I _D = 40A, V _{GS} = 4.5V		19.5		nC
Gate-Source Charge	Q _{gs}	V _{DS} = 10V, I _D = 40A V _{GS} = 10V		8.2		nC
Gate-Drain Charge	Q _{gd}			5.3		nC

SDU/D40N03L

ELECTRICAL CHARACTERISTICS ($T_c=25^{\circ}\text{C}$ unless otherwise noted)

Parameter	Symbol	Condition	Min	Typ	Max	Unit
DRAIN-SOURCE DIODE CHARACTERISTICS^a						
Diode Forward Voltage	V_{SD}	$V_{GS} = 0V, I_s = 25A$			1.3	V

Notes

- a. Pulse Test: Pulse Width $\leq 300\mu s$, Duty Cycle $\leq 2\%$.
- b. Guaranteed by design, not subject to production testing.

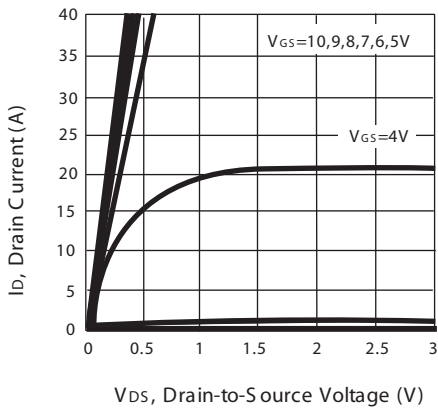

Figure 1. Output Characteristics

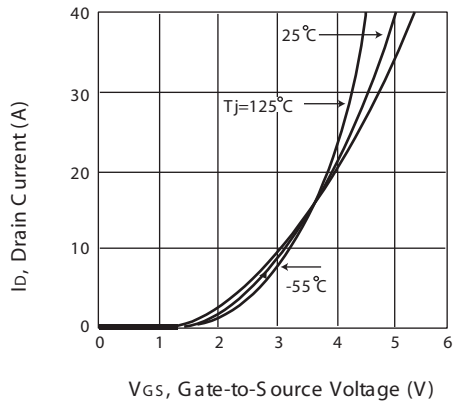

Figure 2. Transfer Characteristics

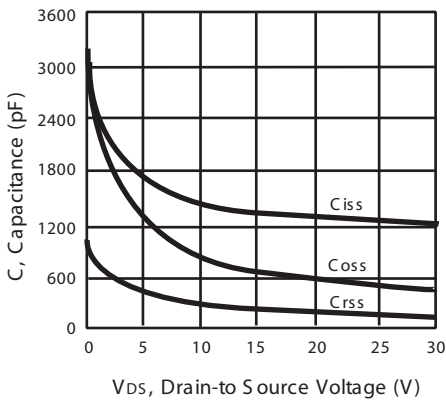

Figure 3. Capacitance

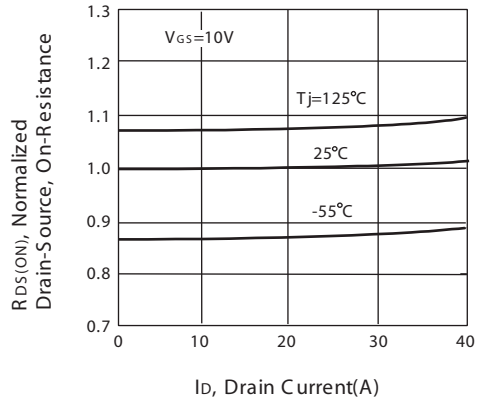

Figure 4. On-Resistance Variation with Drain Current and Temperature

SDU/D40N03L

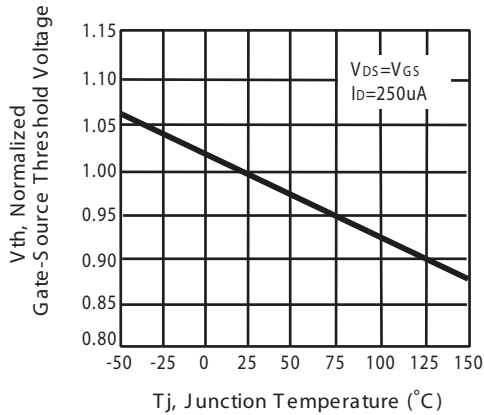

Figure 5. Gate Threshold Variation with Temperature

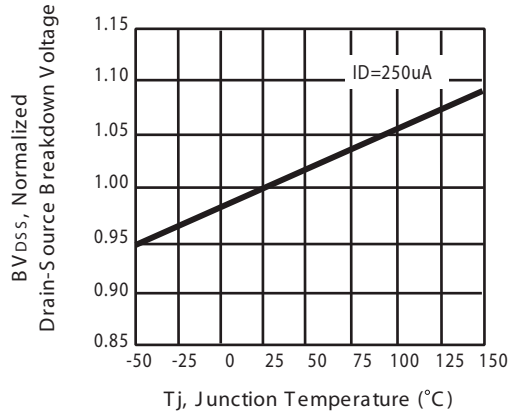

Figure 6. Breakdown Voltage Variation with Temperature

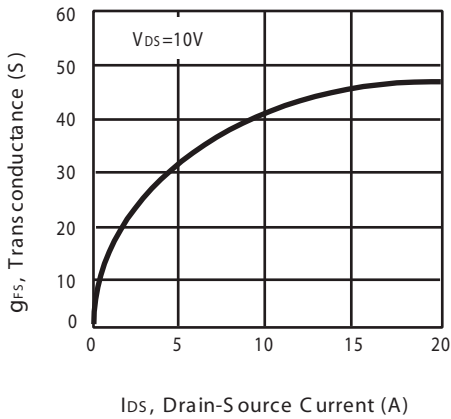

Figure 7. Transconductance Variation with Drain Current

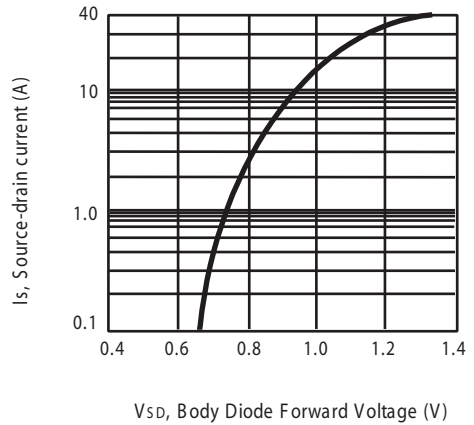

Figure 8. Body Diode Forward Voltage Variation with Source Current

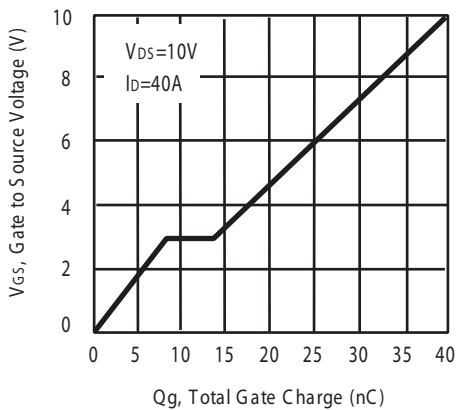

Figure 9. Gate Charge

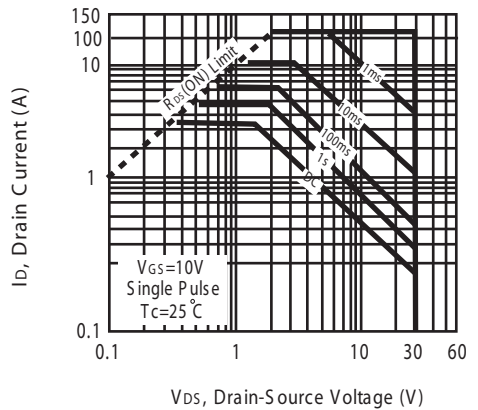

Figure 10. Maximum Safe Operating Area

SDU/D40N03L

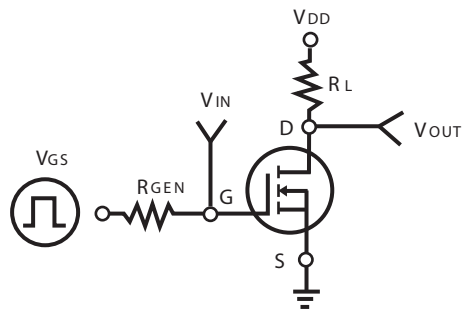

Figure 11. S switching Test Circuit

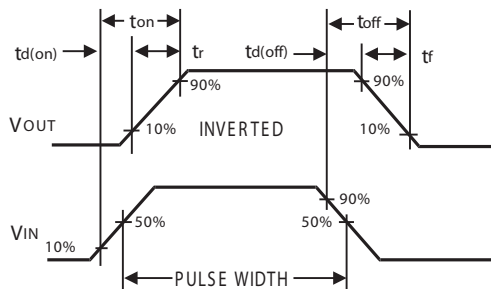

Figure 12. S switching Waveforms

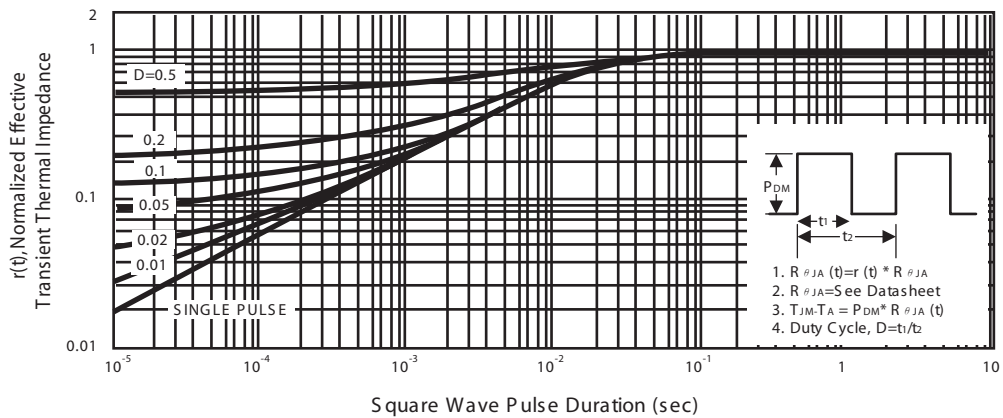

Figure 13. Normalized Thermal Transient Impedance Curve

[查询"SDU40N03L"供应商](#)

[查询"SDU40N03L"供应商](#)

[查询"SDU40N03L"供应商](#)