

2.25MHz, 800mA Synchronous Step-Down Regulator in ThinSOT

FEATURES

- High Efficiency: Up to 95%
- Low Output Ripple (<math><20\text{mV}_{\text{P-P}}</math>): Burst Mode[®] Operation: $I_Q = 16\mu\text{A}$
- 2.5V to 5.5V Input Voltage Range
- 2.25MHz Constant Frequency Operation
- Synchronizable to External Clock
- No Schottky Diode Required
- Stable with Ceramic Capacitors
- Low Dropout Operation: 100% Duty Cycle
- 0.6V Reference Allows Low Output Voltages
- Shutdown Mode Draws <math><1\mu\text{A}</math> Supply Current
- $\pm 2\%$ Output Voltage Accuracy
- Current Mode Operation for Excellent Line and Load Transient Response
- Overtemperature Protected
- Low Profile (1mm) ThinSOT[™] Package

APPLICATIONS

- Cellular Telephones
- Wireless and DSL Modems
- Digital Still Cameras
- Media Players
- Portable Instruments

DESCRIPTION

The LTC[®]3560 is a high efficiency monolithic synchronous buck regulator using a constant frequency, current mode architecture. Supply current during operation is only $16\mu\text{A}$, dropping to $<1\mu\text{A}$ in shutdown. The 2.5V to 5.5V input voltage range makes the LTC3560 ideally suited for single Li-Ion/Li-Polymer battery-powered applications. 100% duty cycle provides low dropout operation, extending battery life in portable systems.

Switching frequency is internally set at 2.25MHz, allowing the use of small surface mount inductors and capacitors. For noise sensitive applications the LTC3560 can be externally synchronized from 1MHz to 3MHz. Burst Mode operation is inhibited during synchronization or when the SYNC/MODE pin is pulled high, preventing low frequency ripple from interfering with audio circuitry.

The internal synchronous switch increases efficiency and eliminates the need for an external Schottky diode. Low output voltages are easily supported with the 0.6V feedback reference voltage. The LTC3560 is available in a low profile (1mm) ThinSOT package.

LT, LTC, LT and Burst Mode are registered trademarks of Linear Technology Corporation. ThinSOT is a trademark of Linear Technology Corporation. All other trademarks are the property of their respective owners. Protected by U.S. Patents, including 6580258, 5481178, 5994885, 6304066, 6498466, 6611131

TYPICAL APPLICATION

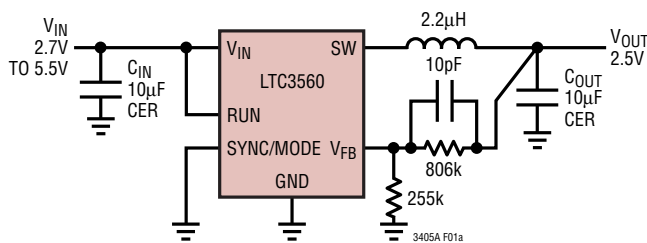

Figure 1a. High Efficiency Step-Down Converter

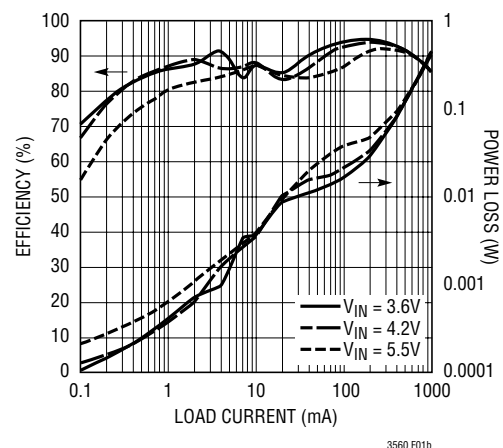

Figure 1b. Efficiency vs Load Current

ABSOLUTE MAXIMUM RATINGS

(Note 1)

Input Supply Voltage	-0.3V to 6V
SYNC/MODE, RUN, V_{FB} Voltages	-0.3V to V_{IN}
SW Voltage (DC)	-0.3V to ($V_{IN} + 0.3V$)
P-Channel Switch Source Current (DC) (Note 6) ...	1.2A
N-Channel Switch Sink Current (DC) (Note 6)	1.2A
Peak SW Sink and Source Current (Note 6)	2.1A
Operating Temperature Range (Note 2) ..	-40°C to 85°C
Junction Temperature (Note 3)	125°C
Storage Temperature Range	-65°C to 150°C
Lead Temperature (Soldering, 10 sec)	300°C

PACKAGE/ORDER INFORMATION

<p>TOP VIEW</p> <p>S6 PACKAGE 6-LEAD PLASTIC TSOT-23 $T_{JMAX} = 125^{\circ}C$, $\theta_{JA} = 250^{\circ}C/W$</p>	
ORDER PART NUMBER	S6 PART MARKING
LTC3560ES6	LTCFY
Order Options Tape and Reel: Add #TR Lead Free: Add #PBF Lead Free Tape and Reel: Add #TRPBF Lead Free Part Marking: http://www.linear.com/leadfree/	

Consult LTC Marketing for parts specified with wider operating temperature ranges.

ELECTRICAL CHARACTERISTICS

The ● denotes specifications which apply over the full operating temperature range, otherwise specifications are $T_A = 25^{\circ}C$.
 $V_{IN} = 3.6V$ unless otherwise specified.

SYMBOL	PARAMETER	CONDITIONS	MIN	TYP	MAX	UNITS	
I_{VFB}	Feedback Current		●		±30	nA	
I_{PK}	Peak Inductor Current	$V_{IN} = 3V$, $V_{FB} = 0.5V$, Duty Cycle < 35%		1.0	1.5	2.0	A
V_{FB}	Regulated Feedback Voltage	(Note 4)	●	0.588	0.6	0.612	V
ΔV_{FB}	Reference Voltage Line Regulation	$V_{IN} = 2.5V$ to $5.5V$ (Note 4)	●		0.04	0.4	%/V
$V_{LOADREG}$	Output Voltage Load Regulation				0.5	%	
V_{IN}	Input Voltage Range		●	2.5		5.5	V
I_S	Input DC Bias Current	(Note 5)					
	Pulse Skipping Mode	$V_{FB} = 0.63V$, Mode = High, $I_{LOAD} = 0A$			200	300	μA
	Burst Mode® Operation	$V_{FB} = 0.63V$, Mode = Low, $I_{LOAD} = 0A$			16	30	μA
	Shutdown	$V_{RUN} = 0V$, $V_{IN} = 5.5V$			0.1	1	μA
f_{OSC}	Oscillator Frequency	$V_{FB} = 0.6V$	●	1.8	2.25	2.7	MHz
f_{SYNC}	SYNC Frequency Range		●	1		3	MHz
R_{PFET}	$R_{DS(ON)}$ of P-Channel FET	$I_{SW} = 100mA$			0.23	0.35	Ω
R_{NFET}	$R_{DS(ON)}$ of N-Channel FET	$I_{SW} = -100mA$			0.21	0.35	Ω
I_{LSW}	SW Leakage	$V_{RUN} = 0V$, $V_{SW} = 0V$ or $5.5V$, $V_{IN} = 5.5V$			±0.01	±1	μA
V_{RUN}	RUN Threshold		●	0.3	1	1.5	V
I_{RUN}	RUN Leakage Current		●		±0.01	±1	μA
$V_{SYNC/MODE}$	SYNC/MODE Threshold		●	0.3	1.0	1.5	V
$I_{SYNC/MODE}$	SYNC/MODE Leakage Current		●		±0.01	±1	μA
$t_{SOFTSTART}$	Soft-Start Time	V_{FB} from 10% to 90% Full Scale		0.6	0.9	1.2	ms

Note 1: Stresses beyond those listed under Absolute Maximum Ratings may cause permanent damage to the device. Exposure to any Absolute Maximum Rating condition for extended periods may affect device reliability and lifetime.

Note 2: The LTC3560E is guaranteed to meet performance specifications from 0°C to 85°C. Specifications over the -40°C to 85°C operating temperature range are assured by design, characterization and correlation with statistical process controls.

ELECTRICAL CHARACTERISTICS

Note 3: T_J is calculated from the ambient temperature T_A and power dissipation P_D according to the following formula:

$$LTC3560: T_J = T_A + (P_D)(250^{\circ}C/W)$$

Note 4: The LTC3560 is tested in a proprietary test mode that connects V_{FB} to the output of the error amplifier.

Note 5: Dynamic supply current is higher due to the gate charge being delivered at the switching frequency.

Note 6: Guaranteed by long-term current density limitations.

Note 7: This IC includes overtemperature protection that is intended to protect the device during momentary overload conditions. Junction temperature will exceed $125^{\circ}C$ when overtemperature protection is active. Continuous operation above the specified maximum operating junction temperature may impair device reliability.

TYPICAL PERFORMANCE CHARACTERISTICS

(From Figure 1a Except for the Resistive Divider Resistor Values)

Efficiency vs Input Voltage

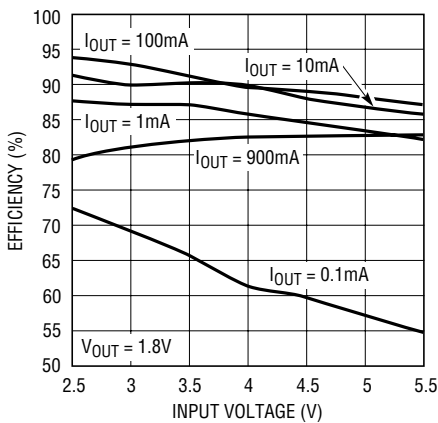

3560 G01

Efficiency vs Output Current

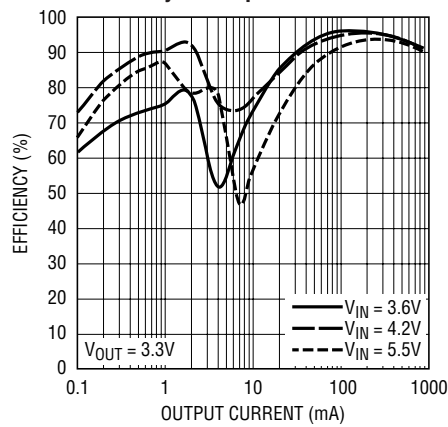

3560 G24

Efficiency vs Output Current

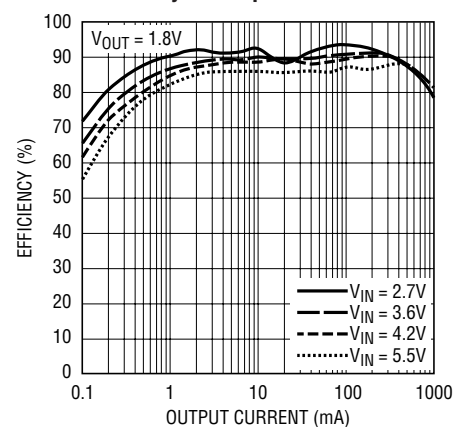

3560 G02

Efficiency vs Output Current

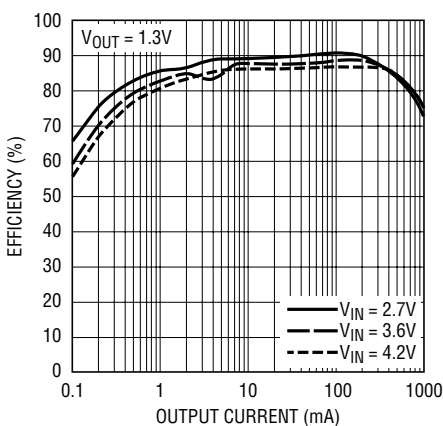

3560 G03

Efficiency vs Output Current

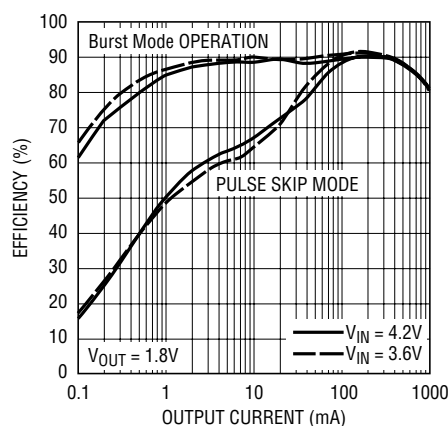

3560 G04

Reference Voltage vs Temperature

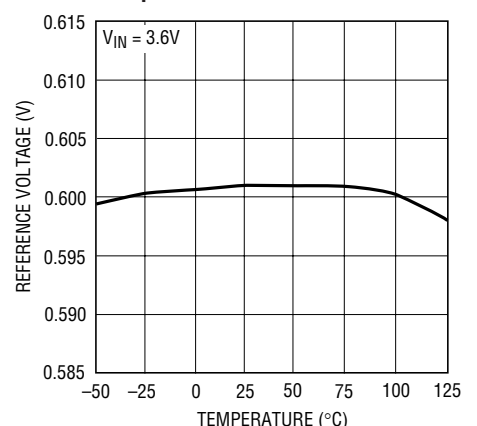

3560 G05

TYPICAL PERFORMANCE CHARACTERISTICS

(From Figure 1a Except for the Resistive Divider Resistor Values)

Oscillator Frequency vs Temperature

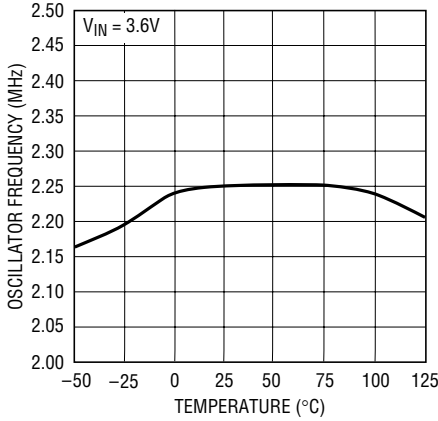

3560 G06

Oscillator Frequency vs Supply Voltage

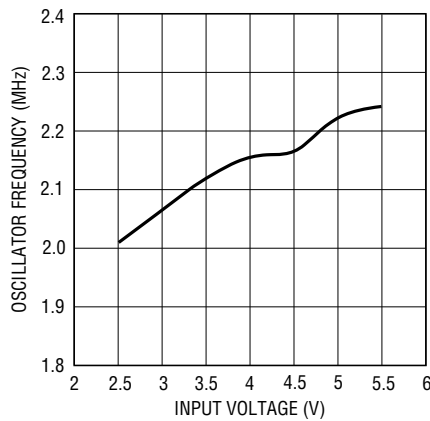

3560 G07

Output Voltage vs Load Current

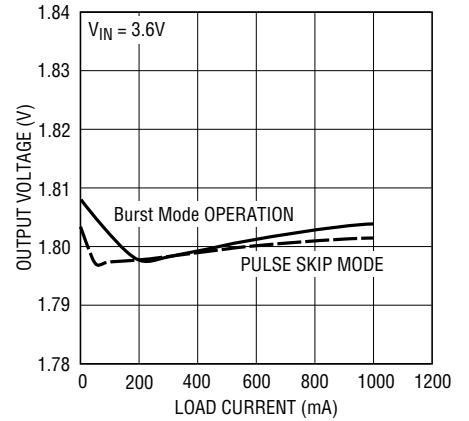

3560 G08

R_{DS(ON)} vs Input Voltage

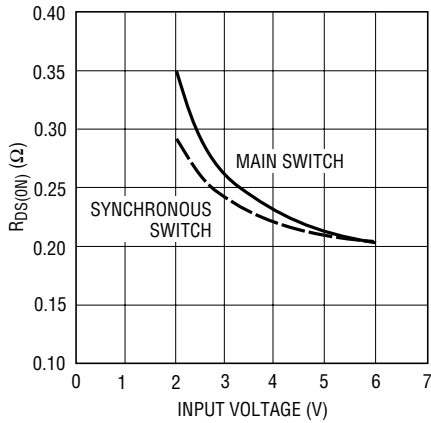

3560 G10

R_{DS(ON)} vs Temperature

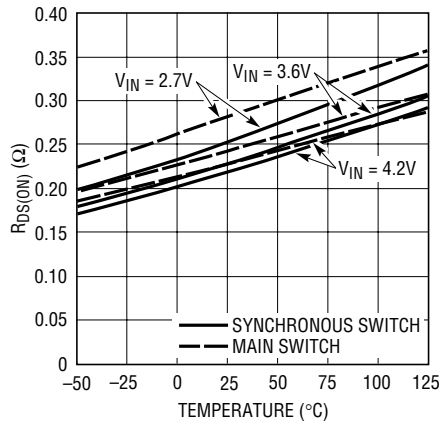

3560 G09

Dynamic Supply Current

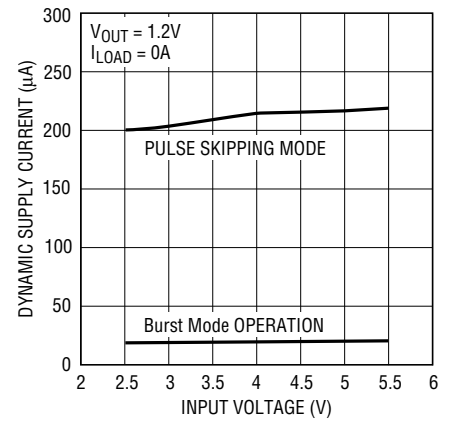

3560 G12

Dynamic Supply Current vs Temperature

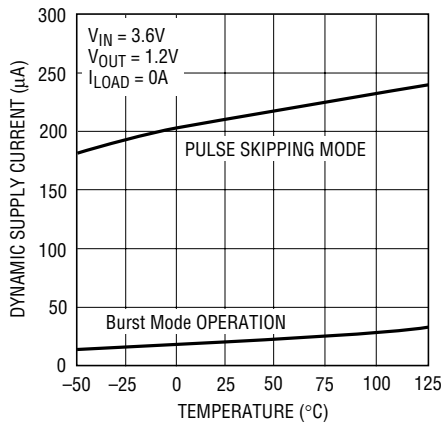

3560 G11

Switch Leakage vs Temperature

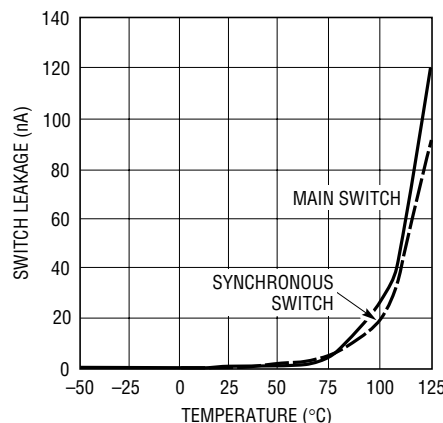

3560 G13

Switch Leakage vs Input Voltage

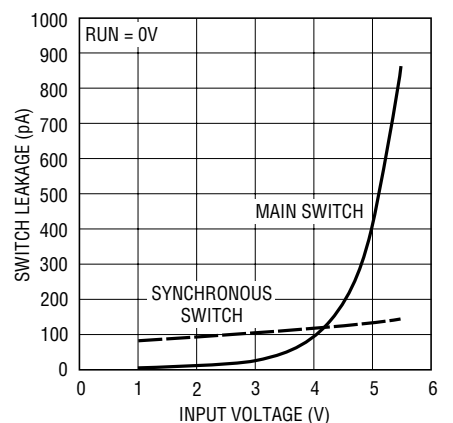

3560 G14

TYPICAL PERFORMANCE CHARACTERISTICS

(From Figure 1a Except for the Resistive Divider Resistor Values)

Burst Mode Operation

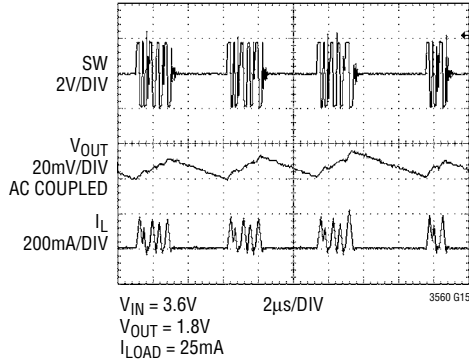

Pulse Skipping Mode Operation

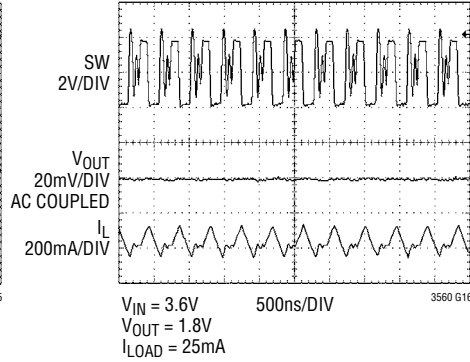

Start-Up from Shutdown

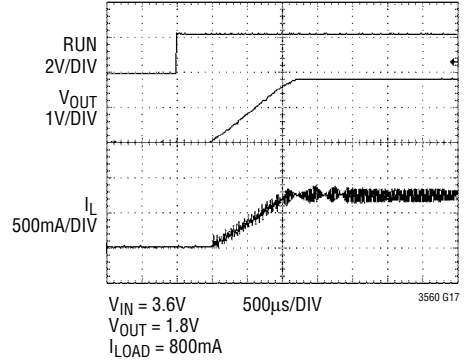

Load Step

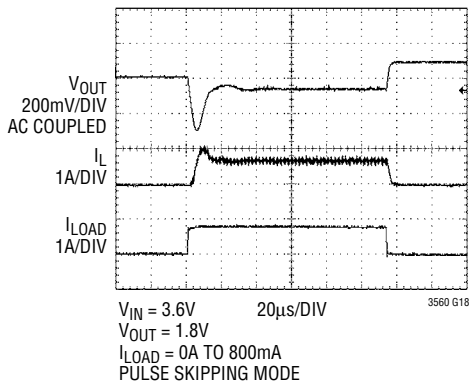

Load Step

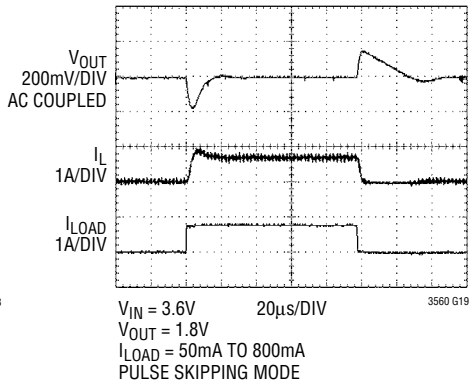

Load Step

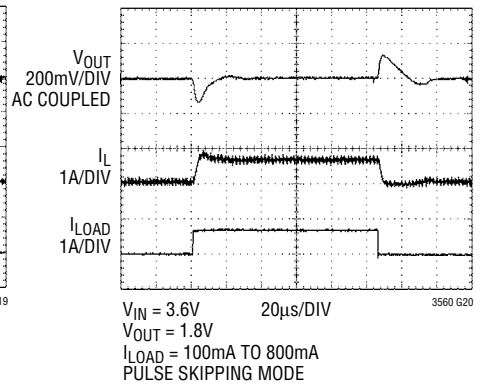

Load Step

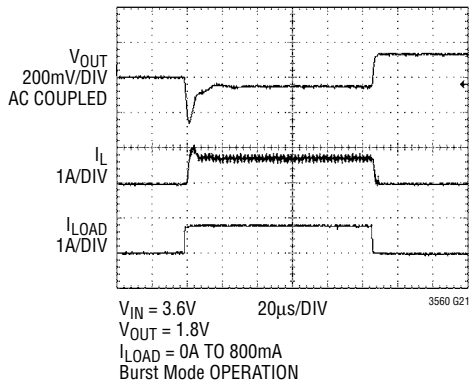

Load Step

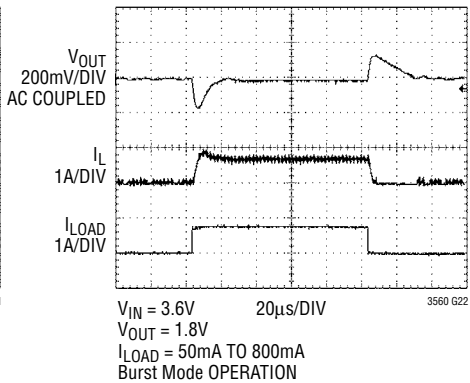

Load Step

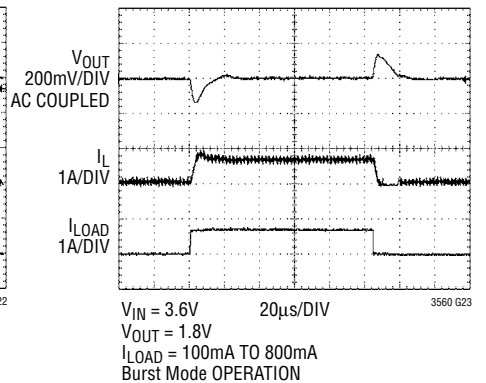

PIN FUNCTIONS

RUN (Pin 1): Run Control Input. Forcing this pin above 1.5V enables the part. Forcing this pin below 0.3V shuts down the device. In shutdown, all functions are disabled drawing $<1\mu\text{A}$ supply current. Do not leave RUN floating.

GND (Pin 2): Ground Pin.

SW (Pin 3): Switch Node Connection to Inductor. This pin connects to the drains of the internal main and synchronous power MOSFET switches.

V_{IN} (Pin 4): Main Supply Pin. Must be closely decoupled to GND, Pin 2, with a $10\mu\text{F}$ or greater ceramic capacitor.

V_{FB} (Pin 5): Feedback Pin. Receives the feedback voltage from an external resistive divider across the output.

SYNC/MODE (Pin 6): External Clock Synchronization and Mode Select Input. To synchronize with an external clock, apply a clock with a frequency between 1MHz and 3MHz. To select pulse skipping mode, tie to V_{IN} . Grounding this pin selects Burst Mode operation. Do not leave this pin floating.

FUNCTIONAL DIAGRAM

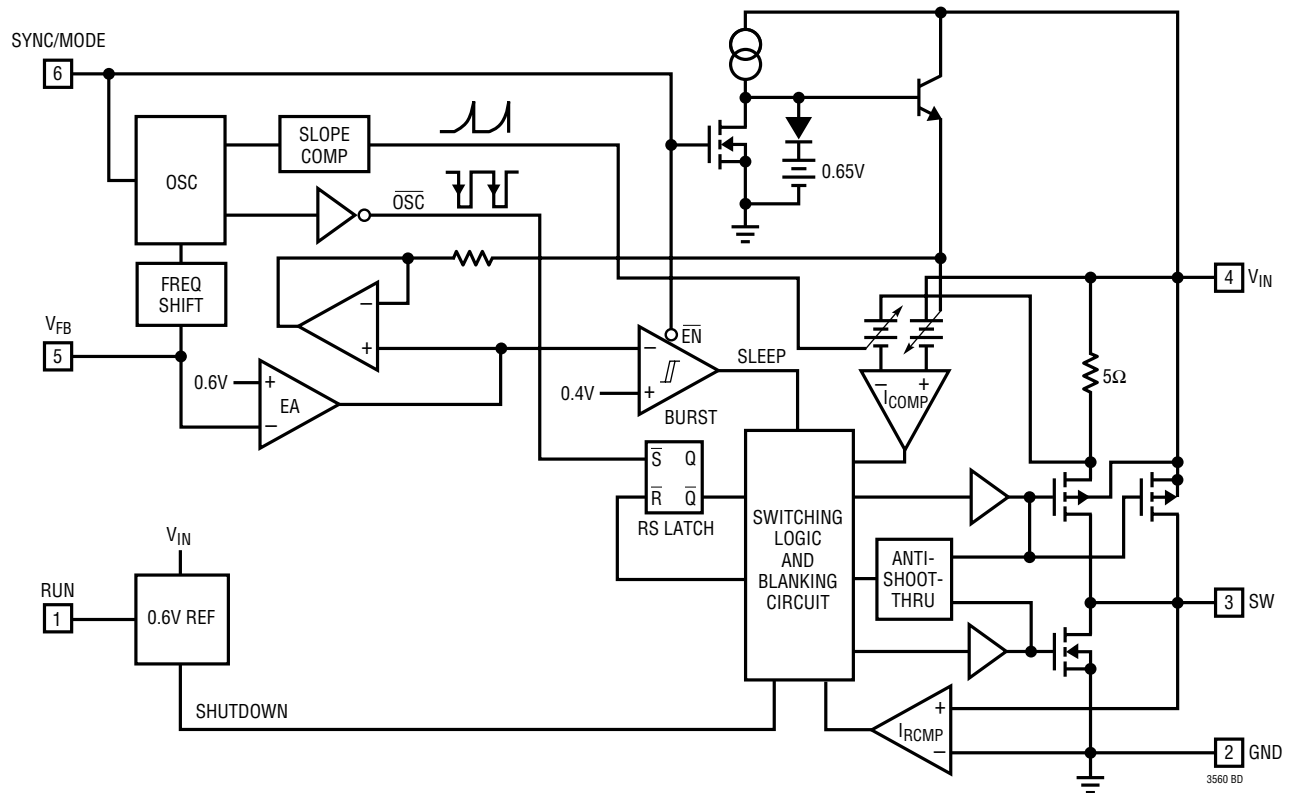

OPERATION (Refer to Functional Diagram)

Main Control Loop

The LTC3560 uses a constant frequency, current mode step-down architecture. Both the main (P-channel MOSFET) and synchronous (N-channel MOSFET) switches are internal. During normal operation, the internal top power MOSFET is turned on each cycle when the oscillator sets the RS latch, and turned off when the current comparator, I_{COMP} , resets the RS latch. The peak inductor current at which I_{COMP} resets the RS latch, is controlled by the output of error amplifier EA. The V_{FB} pin, described in the Pin Functions section, allows EA to receive an output feedback voltage from an external resistive divider. When the load current increases, it causes a slight decrease in the feedback voltage relative to the 0.6V reference, which in turn, causes the EA amplifier's output voltage to increase until the average inductor current matches the new load current. While the top MOSFET is off, the bottom MOSFET is turned on until either the inductor current starts to reverse, as indicated by the current reversal comparator I_{RCMP} , or the beginning of the next clock cycle.

The main control loop is shut down by grounding RUN, resetting the internal soft-start. Re-enabling the main control loop by pulling RUN high activates the internal soft-start, which slowly ramps the output voltage over approximately 0.9ms until it reaches regulation.

Burst Mode Operation

The LTC3560 is capable of Burst Mode operation in which the internal power MOSFETs operate intermittently based on load demand. To enable Burst Mode operation, simply connect the SYNC/MODE pin to GND. To disable Burst Mode operation and enable PWM pulse skipping mode, connect the SYNC/MODE pin to V_{IN} or drive it with a logic high ($V_{MODE} > 1.5V$). In this mode, the efficiency is lower at light loads, but becomes comparable to Burst Mode operation when the output load exceeds 100mA. The advantage of pulse skipping mode is lower output ripple and less interference to audio circuitry.

When the converter is in Burst Mode operation, the peak current of the inductor is set to approximately 150mA regardless of the output load. Each burst event can last from a few cycles at light loads to almost continuously cycling with short sleep intervals at moderate loads. In between these burst events, the power MOSFETs and any unneeded circuitry are turned off, reducing the quiescent current to 16 μ A. In this sleep state, the load current is being supplied solely from the output capacitor. As the output voltage droops, the EA amplifier's output rises above the sleep threshold signaling the BURST comparator to trip and turn the top MOSFET on. This process repeats at a rate that is dependent on the load demand.

Frequency Synchronization

When the LTC3560 is clocked by an external source, Burst Mode operation is disabled; the LTC3560 then operates in PWM pulse-skipping mode. In this mode, when the output load is very low, current comparator I_{COMP} may remain tripped for several cycles and force the main switch to stay off for the same number of cycles. Increasing the output load slightly allows constant frequency PWM operation to resume. This mode exhibits low output ripple as well as low audio noise and reduced RF interference while providing reasonable low current efficiency.

Dropout Operation

As the input supply voltage decreases to a value approaching the output voltage, the duty cycle increases toward the maximum on time. Further reduction of the supply voltage forces the main switch to remain on for more than one cycle until it reaches 100% duty cycle. The output voltage will then be determined by the input voltage minus the voltage drop across the P-channel MOSFET and the inductor.

Another important detail to remember is that at low input supply voltages, the $R_{DS(ON)}$ of the P-channel switch increases (see Typical Performance Characteristics). Therefore, the user should calculate the power dissipation when the LTC3560 is used at 100% duty cycle with low input voltage (See Thermal Considerations in the Applications Information section).

OPERATION (Refer to Functional Diagram)

Slope Compensation and Inductor Peak Current

Slope compensation provides stability in constant frequency architectures by preventing subharmonic oscillations at high duty cycles. It is accomplished internally by adding a compensating ramp to the inductor current signal at duty cycles in excess of 40%. Normally, this

results in a reduction of maximum inductor peak current for duty cycles >40%. However, the LTC3560 uses a patented scheme that counteracts this compensating ramp, which allows the maximum inductor peak current to remain unaffected throughout all duty cycles.

APPLICATIONS INFORMATION

The basic LTC3560 application circuit is shown in Figure 1. External component selection is driven by the load requirement and begins with the selection of L followed by C_{IN} and C_{OUT}.

Inductor Selection

For most applications, the value of the inductor will fall in the range of 1μH to 3.3μH. Its value is chosen based on the desired ripple current. Large value inductors lower ripple current and small value inductors result in higher ripple currents. Higher V_{IN} or V_{OUT} also increases the ripple current as shown in equation 1. A reasonable starting point for setting ripple current is ΔI_L = 320mA (40% of 800mA).

$$\Delta I_L = \frac{1}{(f)(L)} V_{OUT} \left(1 - \frac{V_{OUT}}{V_{IN}} \right) \quad (1)$$

The DC current rating of the inductor should be at least equal to the maximum load current plus half the ripple

current to prevent core saturation. Thus, a 960mA rated inductor should be enough for most applications (800mA + 160mA). For better efficiency, choose a low DC-resistance inductor.

The inductor value also has an effect on Burst Mode operation. The transition to low current operation begins when the inductor current peaks fall to approximately 200mA. Lower inductor values (higher ΔI_L) will cause this to occur at lower load currents, which can cause a dip in efficiency in the upper range of low current operation. In Burst Mode operation, lower inductance values will cause the burst frequency to increase.

Inductor Core Selection

Different core materials and shapes will change the size/current and price/current relationship of an inductor. Toroid or shielded pot cores in ferrite or permalloy materials are small and don't radiate much energy, but generally cost

Table 1. Representative Surface Mount Inductors

MANUFACTURER	PART NUMBER	VALUE	MAX DC CURRENT	DCR	HEIGHT
Toko	A960AW-1R2M-518LC	1.2μH	1.8A	46mΩ	1.8mm
	A960AW-2R3M-518LC	2.3μH	1.5A	63mΩ	1.8mm
	A997AS-3R3M-DB318L	3.3μH	1.2A	70mΩ	1.8mm
Sumida	CDRH2D11/HP-1R5	1.5μH	1.35A	64mΩ	1.2mm
	CDRH3D11/HP-1R5	1.5μH	2A	80mΩ	1.2mm
	CDRH2D18/HP-2R2	2.2μH	1.6A	48mΩ	2.0mm
	CDRH2D14-3R3	3.3μH	1.2A	100mΩ	1.55mm
TDK	VLF3010AT-1R5M1R2	1.5μH	1.2A	68mΩ	1.0mm
	VLF3010AT-2R2M1R0	2.2μH	1.0A	100mΩ	1.0mm
Coilcraft	D01608C-222	2.2μH	2.3A	70mΩ	3.0mm
	LP01704-222M	2.2μH	2.4A	120mΩ	1.0mm
Cooper	SD3112-2R2	2.2μH	1.1A	140mΩ	1.2mm
EPCO	B82470A1222M	2.2μH	1.6A	90mΩ	1.2mm

APPLICATIONS INFORMATION

more than powdered iron core inductors with similar electrical characteristics. The choice of which style inductor to use often depends more on the price vs size requirements and any radiated field/EMI requirements than on what the LTC3560 requires to operate. Table 1 shows some typical surface mount inductors that work well in LTC3560 applications.

C_{IN} and C_{OUT} Selection

In continuous mode, the source current of the top MOSFET is a square wave of duty cycle V_{OUT}/V_{IN}. To prevent large voltage transients, a low ESR input capacitor sized for the maximum RMS current must be used. The maximum RMS capacitor current is given by:

$$C_{IN} \text{ required } I_{RMS} \cong I_{OMAX} \frac{[V_{OUT}(V_{IN} - V_{OUT})]^{1/2}}{V_{IN}}$$

This formula has a maximum at V_{IN} = 2V_{OUT}, where I_{RMS} = I_{OUT}/2. This simple worst-case condition is commonly used for design because even significant deviations do not offer much relief. Note that the capacitor manufacturer's ripple current ratings are often based on 2000 hours of life. This makes it advisable to further derate the capacitor, or choose a capacitor rated at a higher temperature than required. Always consult the manufacturer if there is any question.

The selection of C_{OUT} is driven by the required effective series resistance (ESR). Typically, once the ESR requirement for C_{OUT} has been met, the RMS current rating generally far exceeds the I_{RIPPLE(P-P)} requirement. The output ripple ΔV_{OUT} is determined by:

$$\Delta V_{OUT} \cong \Delta I_L \left(ESR + \frac{1}{8fC_{OUT}} \right)$$

where f = operating frequency, C_{OUT} = output capacitance and ΔI_L = ripple current in the inductor. For a fixed output voltage, the output ripple is highest at maximum input voltage since ΔI_L increases with input voltage.

If tantalum capacitors are used, it is critical that the capacitors are surge tested for use in switching power

supplies. An excellent choice is the AVX TPS series of surface mount tantalum. These are specially constructed and tested for low ESR so they give the lowest ESR for a given volume. Other capacitor types include Sanyo POSCAP, Kemet T510 and T495 series, and Sprague 593D and 595D series. Consult the manufacturer for other specific recommendations.

Using Ceramic Input and Output Capacitors

Higher values, lower cost ceramic capacitors are now becoming available in smaller case sizes. Their high ripple current, high voltage rating and low ESR make them ideal for switching regulator applications. Because the LTC3560's control loop does not depend on the output capacitor's ESR for stable operation, ceramic capacitors can be used freely to achieve very low output ripple and small circuit size.

However, care must be taken when ceramic capacitors are used at the input and the output. When a ceramic capacitor is used at the input and the power is supplied by a wall adapter through long wires, a load step at the output can induce ringing at the input, V_{IN}. At best, this ringing can couple to the output and be mistaken as loop instability. At worst, a sudden inrush of current through the long wires can potentially cause a voltage spike at V_{IN}, large enough to damage the part.

When choosing the input and output ceramic capacitors, choose the X5R or X7R dielectric formulations. These dielectrics have the best temperature and voltage characteristics of all the ceramics for a given value and size.

Output Voltage Programming

The output voltage is set by a resistive divider according to the following formula:

$$V_{OUT} = 0.6V \left(1 + \frac{R2}{R1} \right) \quad (2)$$

The external resistive divider is connected to the output, allowing remote voltage sensing as shown in Figure 2.

APPLICATIONS INFORMATION

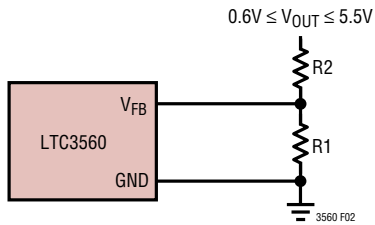

Figure 2. Setting the LTC3560 Output Voltage

Efficiency Considerations

The efficiency of a switching regulator is equal to the output power divided by the input power times 100%. It is often useful to analyze individual losses to determine what is limiting the efficiency and which change would produce the most improvement. Efficiency can be expressed as:

$$\text{Efficiency} = 100\% - (L1 + L2 + L3 + \dots)$$

where L1, L2, etc. are the individual losses as a percentage of input power.

Although all dissipative elements in the circuit produce losses, two main sources usually account for most of the losses in LTC3560 circuits: V_{IN} quiescent current and I^2R losses. The V_{IN} quiescent current loss dominates the efficiency loss at very low load currents whereas the I^2R loss dominates the efficiency loss at medium to high load currents. In a typical efficiency plot, the efficiency curve at very low load currents can be misleading since the actual power lost is of no consequence as illustrated in Figure 3.

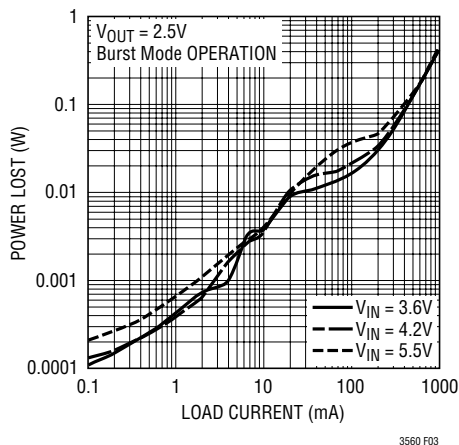

Figure 3. Power Lost vs Load Current

1. The V_{IN} quiescent current is due to two components: the DC bias current as given in the electrical characteristics and the internal main switch and synchronous switch gate charge currents. The gate charge current results from switching the gate capacitance of the internal power MOSFET switches. Each time the gate is switched from high to low to high again, a packet of charge, dQ , moves from V_{IN} to ground. The resulting dQ/dt is the current out of V_{IN} that is typically larger than the DC bias current. In continuous mode, $I_{GATECHG} = f(Q_T + Q_B)$ where Q_T and Q_B are the gate charges of the internal top and bottom switches. Both the DC bias and gate charge losses are proportional to V_{IN} and thus their effects will be more pronounced at higher supply voltages.
2. I^2R losses are calculated from the resistances of the internal switches, R_{SW} , and external inductor R_L . In continuous mode, the average output current flowing through inductor L is “chopped” between the main switch and the synchronous switch. Thus, the series resistance looking into the SW pin is a function of both top and bottom MOSFET $R_{DS(ON)}$ and the duty cycle (DC) as follows:

$$R_{SW} = (R_{DS(ON)TOP})(DC) + (R_{DS(ON)BOT})(1 - DC)$$

The $R_{DS(ON)}$ for both the top and bottom MOSFETs can be obtained from the Typical Performance Characteristics curves. Thus, to obtain I^2R losses, simply add R_{SW} to R_L and multiply the result by the square of the average output current.

Other losses including C_{IN} and C_{OUT} ESR dissipative losses and inductor core losses generally account for less than 2% total additional loss.

Thermal Considerations

In most applications the LTC3560 does not dissipate much heat due to its high efficiency. But, in applications where the LTC3560 is running at high ambient temperature with low supply voltage and high duty cycles, such as in dropout, the heat dissipated may exceed the maximum junction temperature of the part. If the junction temperature reaches approximately 150°C,

APPLICATIONS INFORMATION

both power switches will be turned off and the SW node will become high impedance.

To avoid the LTC3560 from exceeding the maximum junction temperature, the user will need to do some thermal analysis. The goal of the thermal analysis is to determine whether the power dissipated exceeds the maximum junction temperature of the part. The temperature rise is given by:

$$T_R = (P_D)(\theta_{JA})$$

where P_D is the power dissipated by the regulator and θ_{JA} is the thermal resistance from the junction of the die to the ambient temperature.

The junction temperature, T_J , is given by:

$$T_J = T_A + T_R$$

where T_A is the ambient temperature.

As an example, consider the LTC3560 in dropout at an input voltage of 2.7V, a load current of 800mA and an ambient temperature of 70°C. From the typical performance graph of switch resistance, the $R_{DS(ON)}$ of the P-channel switch at 70°C is approximately 0.31Ω. Therefore, power dissipated by the part is:

$$P_D = I_{LOAD}^2 \cdot R_{DS(ON)} = 198mW$$

For the SOT-23 package, the θ_{JA} is 250°C/W. Thus, the junction temperature of the regulator is:

$$T_J = 70^\circ C + (0.198)(250) = 120^\circ C$$

which is below the maximum junction temperature of 125°C.

Note that at higher supply voltages, the junction temperature is lower due to reduced switch resistance ($R_{DS(ON)}$).

Checking Transient Response

The regulator loop response can be checked by looking at the load transient response. Switching regulators take several cycles to respond to a step in load current. When a load step occurs, V_{OUT} immediately shifts by an amount equal to $(\Delta I_{LOAD} \cdot ESR)$, where ESR is the effective series resistance of C_{OUT} . ΔI_{LOAD} also begins to charge or discharge C_{OUT} , which generates a feedback error signal. The regulator loop then acts to return V_{OUT} to its steady-state

value. During this recovery time V_{OUT} can be monitored for overshoot or ringing that would indicate a stability problem. For a detailed explanation of switching control loop theory, see Application Note 76.

A second, more severe transient is caused by switching in loads with large ($>1\mu F$) supply bypass capacitors. The discharged bypass capacitors are effectively put in parallel with C_{OUT} , causing a rapid drop in V_{OUT} . No regulator can deliver enough current to prevent this problem if the load switch resistance is low and it is driven quickly. The only solution is to limit the rise time of the switch drive so that the load rise time is limited to approximately $(25 \cdot C_{LOAD})$. Thus, a 10μF capacitor charging to 3.3V would require a 250μs rise time, limiting the charging current to about 130mA.

PC Board Layout Checklist

When laying out the printed circuit board, the following checklist should be used to ensure proper operation of the LTC3560. These items are also illustrated graphically in Figures 4 and 5. Check the following in your layout:

1. The power traces, consisting of the GND trace, the SW trace and the V_{IN} trace should be kept short, direct and wide.
2. Does the V_{FB} pin connect directly to the feedback resistors? The resistive divider R1/R2 must be connected between the (+) plate of C_{OUT} and ground.
3. Does the (+) plate of C_{IN} connect to V_{IN} as closely as possible? This capacitor provides the AC current to the internal power MOSFETs.
4. Keep the (–) plates of C_{IN} and C_{OUT} as close as possible.
5. Keep the switching node, SW, away from the sensitive V_{FB} node.

Design Example

As a design example, assume the LTC3560 is used in a single lithium-ion battery-powered cellular phone application. The V_{IN} will be operating from a maximum of 4.2V down to about 2.7V. The load current requirement is a maximum of 0.8A but most of the time it will be in

APPLICATIONS INFORMATION

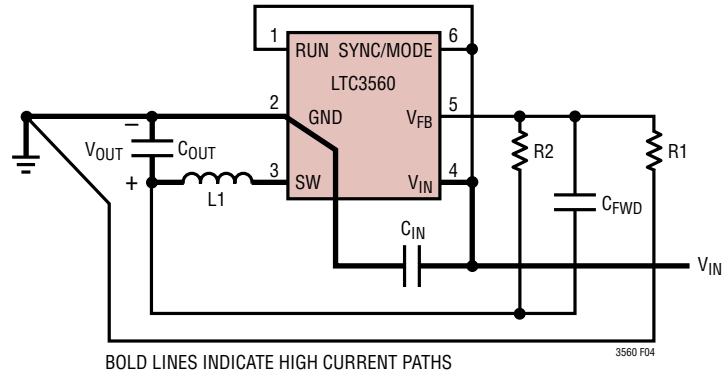

Figure 4. LTC3560 Layout Diagram

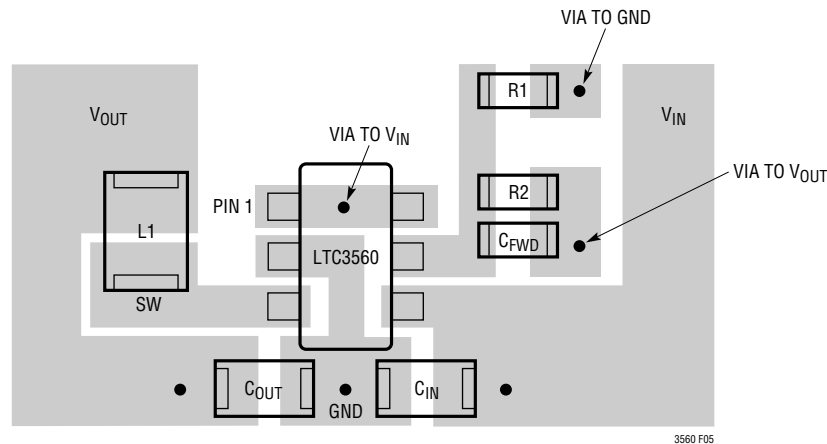

Figure 5. LTC3560 Suggested Layout

standby mode, requiring only 2mA. Efficiency at both low and high load currents is important. Output voltage is 2.5V. With this information we can calculate L using equation (1),

$$L = \frac{1}{(f)(\Delta I_L)} V_{OUT} \left(1 - \frac{V_{OUT}}{V_{IN}} \right) \quad (3)$$

Substituting $V_{OUT} = 2.5V$, $V_{IN} = 4.2V$, $\Delta I_L = 320mA$ and $f = 2.25MHz$ in equation (3) gives:

$$L = \frac{2.5V}{2.25MHz(320mA)} \left(1 - \frac{2.5V}{4.2V} \right) \cong 1.4\mu H$$

A 1.5 μH inductor works well for this application. For best efficiency choose a 960mA or greater inductor with less than 0.2 Ω series resistance.

C_{IN} will require an RMS current rating of at least $0.4A \cong I_{LOAD(MAX)}/2$ at temperature and C_{OUT} will require an ESR of less than 0.1 Ω . In most cases, a ceramic capacitor will satisfy this requirement.

For the feedback resistors, choose $R1 = 309k$. $R2$ can then be calculated from equation (2) to be:

$$R2 = \left(\frac{V_{OUT}}{0.6} - 1 \right) R1 = 978.5k; \text{ use } 976k$$

Figure 6 shows the complete circuit along with its efficiency curve.

APPLICATIONS INFORMATION

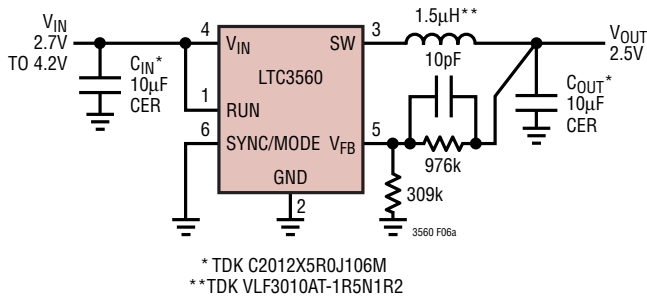

Figure 6a

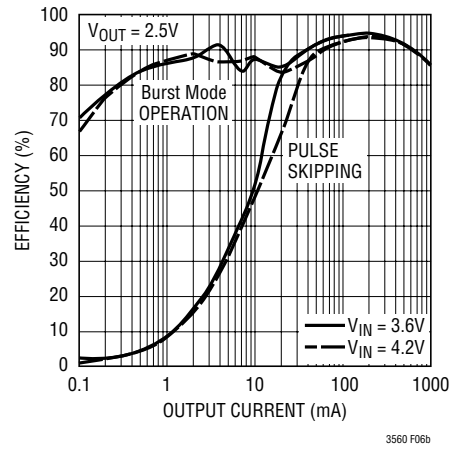

Figure 6b

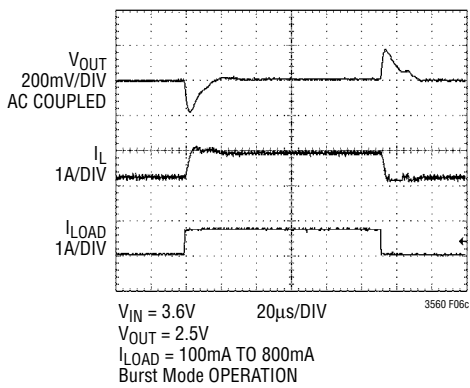

Figure 6c

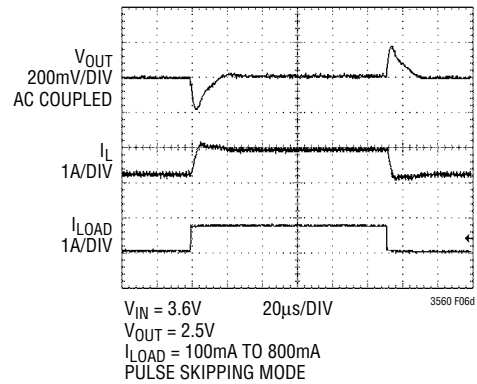

Figure 6d

APPLICATIONS INFORMATION

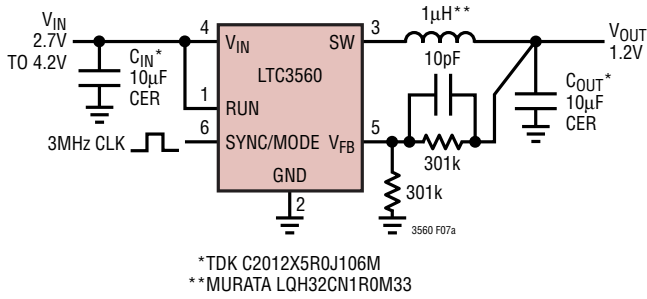

Figure 7a

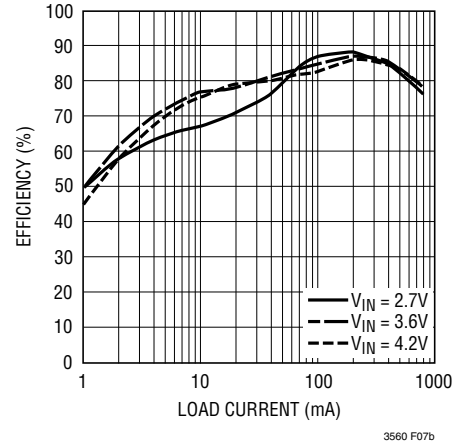

Figure 7b

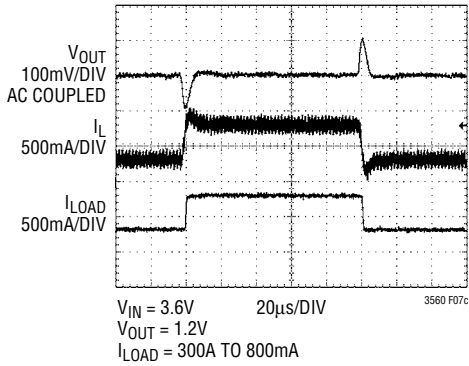

Figure 7c

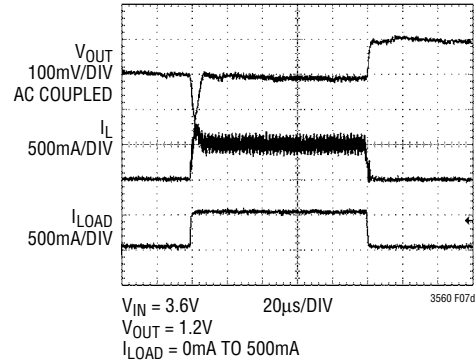
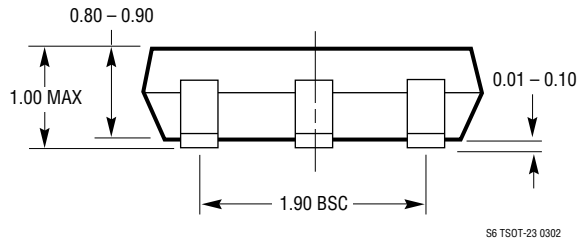
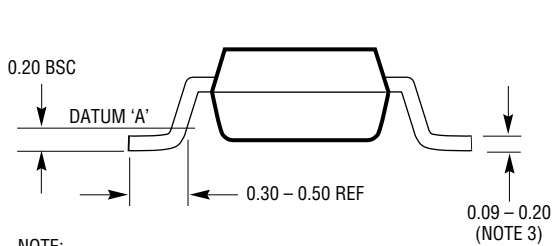
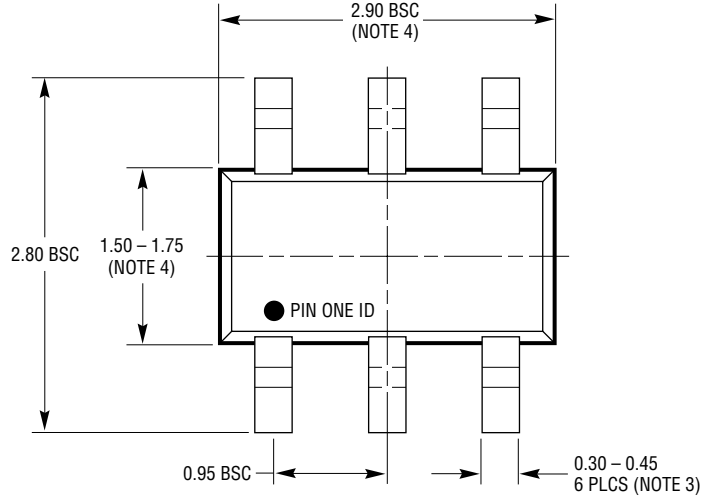
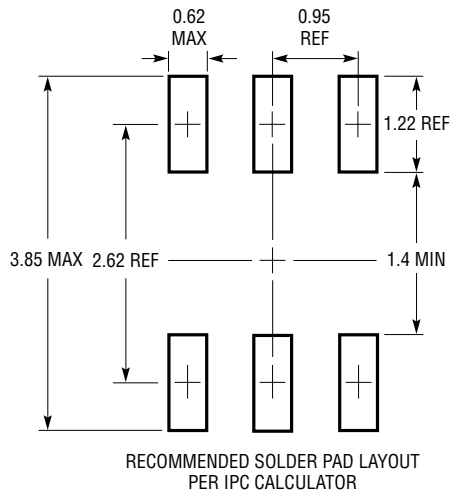

Figure 7d

PACKAGE DESCRIPTION

S6 Package
6-Lead Plastic TSOT-23
 (Reference LTC DWG # 05-08-1636)



- NOTE:
1. DIMENSIONS ARE IN MILLIMETERS
 2. DRAWING NOT TO SCALE
 3. DIMENSIONS ARE INCLUSIVE OF PLATING
 4. DIMENSIONS ARE EXCLUSIVE OF MOLD FLASH AND METAL BURR
 5. MOLD FLASH SHALL NOT EXCEED 0.254mm
 6. JEDEC PACKAGE REFERENCE IS MO-193

RELATED PARTS

PART NUMBER	DESCRIPTION	COMMENTS
LTC3405/LTC3405A	300mA (I_{OUT}), 1.5MHz, Synchronous Step-Down DC/DC Converters	95% Efficiency, V_{IN} : 2.5V to 5.5V, $V_{OUT(MIN)} = 0.8V$, $I_Q = 20\mu A$, $I_{SD} = <1\mu A$, ThinSOT Package
LTC3406/LTC3406B	600mA (I_{OUT}), 1.5MHz, Synchronous Step-Down DC/DC Converters	96% Efficiency, V_{IN} : 2.5V to 5.5V, $V_{OUT(MIN)} = 0.6V$, $I_Q = 20\mu A$, $I_{SD} = <1\mu A$, ThinSOT Package
LTC3407/LTC3407-2	Dual 600mA/800mA (I_{OUT}), 1.5MHz/2.25MHz, Synchronous Step-Down DC/DC Converters	95% Efficiency, V_{IN} : 2.5V to 5.5V, $V_{OUT(MIN)} = 0.6V$, $I_Q = 40\mu A$, $I_{SD} = <1\mu A$, MS10E, DFN Packages
LTC3409	600mA (I_{OUT}), 1.7MHz/2.6MHz, Synchronous Step-Down DC/DC Converter	96% Efficiency, V_{IN} : 1.6V to 5.5V, $V_{OUT(MIN)} = 0.6V$, $I_Q = 65\mu A$, $I_{SD} = <1\mu A$, DFN Package
LTC3410/LTC3410B	300mA (I_{OUT}), 2.25MHz, Synchronous Step-Down DC/DC Converters	95% Efficiency, V_{IN} : 2.5V to 5.5V, $V_{OUT(MIN)} = 0.8V$, $I_Q = 26\mu A$, $I_{SD} = <1\mu A$, SC70 Package
LTC3411	1.25A (I_{OUT}), 4MHz, Synchronous Step-Down DC/DC Converter	95% Efficiency, V_{IN} : 2.5V to 5.5V, $V_{OUT(MIN)} = 0.8V$, $I_Q = 60\mu A$, $I_{SD} = <1\mu A$, MS10, DFN Packages
LTC3412	2.5A (I_{OUT}), 4MHz, Synchronous Step-Down DC/DC Converter	95% Efficiency, V_{IN} : 2.5V to 5.5V, $V_{OUT(MIN)} = 0.8V$, $I_Q = 60\mu A$, $I_{SD} = <1\mu A$, TSSOP-16E Package
LTC3441/LTC3442 LTC3443	1.2A (I_{OUT}), 2MHz, Synchronous Buck-Boost DC/DC Converters	95% Efficiency, V_{IN} : 2.4V to 5.5V, $V_{OUT(MIN)}$: 2.4V to 5.25V, $I_Q = 50\mu A$, $I_{SD} = <1\mu A$, DFN Package
LTC3531/LTC3531-3 LTC3531-3.3	200mA (I_{OUT}), 1.5MHz, Synchronous Buck-Boost DC/DC Converters	95% Efficiency, V_{IN} : 1.8V to 5.5V, $V_{OUT(MIN)}$: 2V to 5V, $I_Q = 16\mu A$, $I_{SD} = <1\mu A$, ThinSOT, DFN Packages
LTC3532	500mA (I_{OUT}), 2MHz, Synchronous Buck-Boost DC/DC Converter	95% Efficiency, V_{IN} : 2.4V to 5.5V, $V_{OUT(MIN)}$: 2.4V to 5.25V, $I_Q = 35\mu A$, $I_{SD} = <1\mu A$, MS10, DFN Packages
LTC3548/LTC3548-1 LTC3548-2	Dual 400mA/800mA (I_{OUT}), 2.25MHz, Synchronous Step-Down DC/DC Converters	95% Efficiency, V_{IN} : 2.5V to 5.5V, $V_{OUT(MIN)} = 0.6V$, $I_Q = 40\mu A$, $I_{SD} = <1\mu A$, MS10E, DFN Packages
LTC3561	1.25A (I_{OUT}), 4MHz, Synchronous Step-Down DC/DC Converter	95% Efficiency, V_{IN} : 2.5V to 5.5V, $V_{OUT(MIN)} = 0.8V$, $I_Q = 240\mu A$, $I_{SD} = <1\mu A$, DFN Package