

SKM 200GB128D

查询"SKM200GB128D_06"供应商



SEMITRANS® 3

SPT IGBT Module

SKM 200GB128D

Features

- Homogeneous Si
- SPT = Soft-Punch-Through technology
- V_{CEsat} with positive temperature coefficient
- High short circuit capability, self limiting to $6 \times I_C$

Typical Applications

- AC inverter drives
- UPS
- Electronic welders f_{sw} up to 20kHz

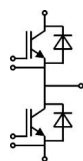

GB

Absolute Maximum Ratings		$T_C = 25^\circ\text{C}$, unless otherwise specified			
Symbol	Conditions	Values			Units
IGBT					
V_{CES}	$T_j = 150^\circ\text{C}$	1200			V
I_C	$T_j = 150^\circ\text{C}$	$T_C = 25^\circ\text{C}$	300		A
		$T_C = 80^\circ\text{C}$	220		A
I_{CRM}	$I_{CRM} = 2 \times I_{Cnom}$	300			A
V_{GES}		± 20			V
t_{psc}	$V_{CC} = 600\text{ V}; V_{GE} \leq 20\text{ V}; T_j = 125^\circ\text{C}$ $V_{CES} < 1200\text{ V}$	10			μs
Inverse Diode					
I_F	$T_j = 150^\circ\text{C}$	$T_{case} = 25^\circ\text{C}$	190		A
		$T_{case} = 80^\circ\text{C}$	130		A
I_{FRM}	$I_{FRM} = 2 \times I_{Fnom}$	300			A
I_{FSM}	$t_p = 10\text{ ms}; \text{sin.}$	$T_j = 150^\circ\text{C}$	1440		A
Module					
$I_{t(RMS)}$		500			A
T_{vj}		- 40... + 150			$^\circ\text{C}$
T_{stg}		- 40... + 125			$^\circ\text{C}$
V_{isol}	AC, 1 min.	4000			V

Characteristics		$T_C = 25^\circ\text{C}$, unless otherwise specified				
Symbol	Conditions	min.	typ.	max.	Units	
IGBT						
$V_{GE(th)}$	$V_{GE} = V_{CE}, I_C = 6\text{ mA}$	4,5	5,5	6,45	V	
I_{CES}	$V_{GE} = 0\text{ V}, V_{CE} = V_{CES}$		0,2	0,6	mA	
V_{CE0}		$T_j = 25^\circ\text{C}$	1		1,15	V
		$T_j = 125^\circ\text{C}$	0,9		1,05	V
r_{CE}	$V_{GE} = 15\text{ V}$	$T_j = 25^\circ\text{C}$	6		8	m Ω
		$T_j = 125^\circ\text{C}$	8		10	m Ω
$V_{CE(sat)}$	$I_{Cnom} = 150\text{ A}, V_{GE} = 15\text{ V}$	$T_j = 25^\circ\text{C}_{chiplev.}$	1,9		2,35	V
		$T_j = 125^\circ\text{C}_{chiplev.}$	2,1		2,55	V
C_{ies}	$V_{CE} = 25, V_{GE} = 0\text{ V}$	$f = 1\text{ MHz}$	13		nF	
C_{oes}			2		nF	
C_{res}			2		nF	
Q_G	$V_{GE} = -8\text{V} - +20\text{V}$	1700			nC	
R_{Gint}	$T_j = 25^\circ\text{C}$	2,5			Ω	
$t_{d(on)}$	$R_{Gon} = 7\ \Omega$ $di/dt = 4800\text{ A}/\mu\text{s}$	$V_{CC} = 600\text{V}$ $I_{Cnom} = 150\text{A}$	125		ns	
t_r			50		ns	
E_{on}			18		mJ	
$t_{d(off)}$	$R_{Goff} = 7\ \Omega$	$T_j = 125^\circ\text{C}$ $V_{GE} = \pm 15\text{V}$ $L_s = 20\text{ nH}$	620		ns	
t_f			55		ns	
E_{off}			15		mJ	
$R_{th(j-c)}$	per IGBT	0,095			K/W	

SKM 200GB128D

查询"SKM200GB128D_06"供应商



SEMITRANS® 3

SPT IGBT Module

SKM 200GB128D

Features

- Homogeneous Si
- SPT = Soft-Punch-Through technology
- V_{CEsat} with positive temperature coefficient
- High short circuit capability, self limiting to $6 \times I_c$

Typical Applications

- AC inverter drives
- UPS
- Electronic welders f_{sw} up to 20kHz

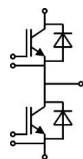

GB

Characteristics

Symbol	Conditions	min.	typ.	max.	Units
Inverse Diode					
$V_F = V_{EC}$	$I_{Fnom} = 150 \text{ A}; V_{GE} = 0 \text{ V}$	$T_j = 25 \text{ }^\circ\text{C}_{chiplev.}$	2	2,5	V
		$T_j = 125 \text{ }^\circ\text{C}_{chiplev.}$	1,8		V
V_{F0}		$T_j = 25 \text{ }^\circ\text{C}$	1,1	1,2	V
r_F		$T_j = 25 \text{ }^\circ\text{C}$	6	7,8	mΩ
I_{RRM}	$I_{Fnom} = 150 \text{ A}$	$T_j = 125 \text{ }^\circ\text{C}$	190		A
Q_{rr}	$di/dt = 4800 \text{ A}/\mu\text{s}$		24		μC
E_{rr}	$V_{GE} = -15 \text{ V}; V_{CC} = 600 \text{ V}$		8		mJ
$R_{th(j-c)D}$	per diode			0,25	K/W
Module					
L_{CE}			15	20	nH
R_{CC+EE}	res., terminal-chip	$T_{case} = 25 \text{ }^\circ\text{C}$	0,35		mΩ
		$T_{case} = 125 \text{ }^\circ\text{C}$	0,5		mΩ
$R_{th(c-s)}$	per module			0,038	K/W
M_s	to heat sink M6		3	5	Nm
M_t	to terminals M6		2,5	5	Nm
w				325	g

This is an electrostatic discharge sensitive device (ESDS), international standard IEC 60747-1, Chapter IX.

This technical information specifies semiconductor devices but promises no characteristics. No warranty or guarantee expressed or implied is made regarding delivery, performance or suitability.

SKM 200GB128D

[查询"SKM200GB128D_06"供应商](#)



SEMITRANS[®] 3

SPT IGBT Module

SKM 200GB128D

Features

- Homogeneous Si
- SPT = Soft-Punch-Through technology
- V_{CEsat} with positive temperature coefficient
- High short circuit capability, self limiting to $6 \times I_c$

Typical Applications

- AC inverter drives
- UPS
- Electronic welders f_{sw} up to 20kHz

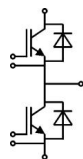

GB

Symbol	Conditions	Values	Units
Z_{th(j-c)I}			
$R_{\theta j-c1}$	$i = 1$	65	mk/W
$R_{\theta j-c2}$	$i = 2$	22	mk/W
$R_{\theta j-c3}$	$i = 3$	6,8	mk/W
$R_{\theta j-c4}$	$i = 4$	1,2	mk/W
$\tau_{\theta j-c1}$	$i = 1$	0,0744	s
$\tau_{\theta j-c2}$	$i = 2$	0,0078	s
$\tau_{\theta j-c3}$	$i = 3$	0,0016	s
$\tau_{\theta j-c4}$	$i = 4$	0,0002	s
Z_{th(j-c)D}			
$R_{\theta j-c1}$	$i = 1$	155	mk/W
$R_{\theta j-c2}$	$i = 2$	71	mk/W
$R_{\theta j-c3}$	$i = 3$	21	mk/W
$R_{\theta j-c4}$	$i = 4$	3	mk/W
$\tau_{\theta j-c1}$	$i = 1$	0,0716	s
$\tau_{\theta j-c2}$	$i = 2$	0,0056	s
$\tau_{\theta j-c3}$	$i = 3$	0,0042	s
$\tau_{\theta j-c4}$	$i = 4$	0,0002	s

查询"SKM200GB128D_06"供应商

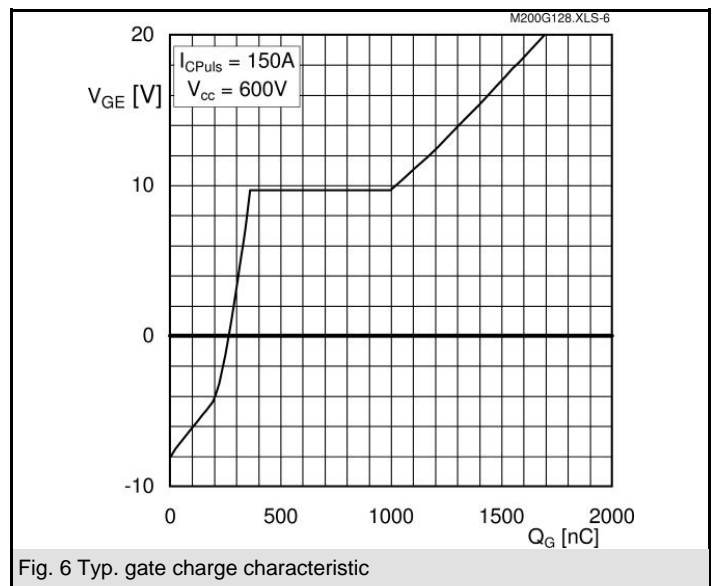
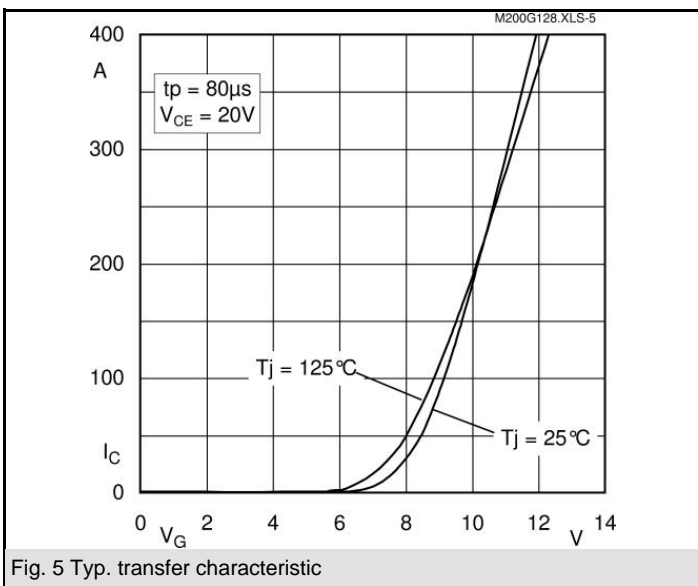
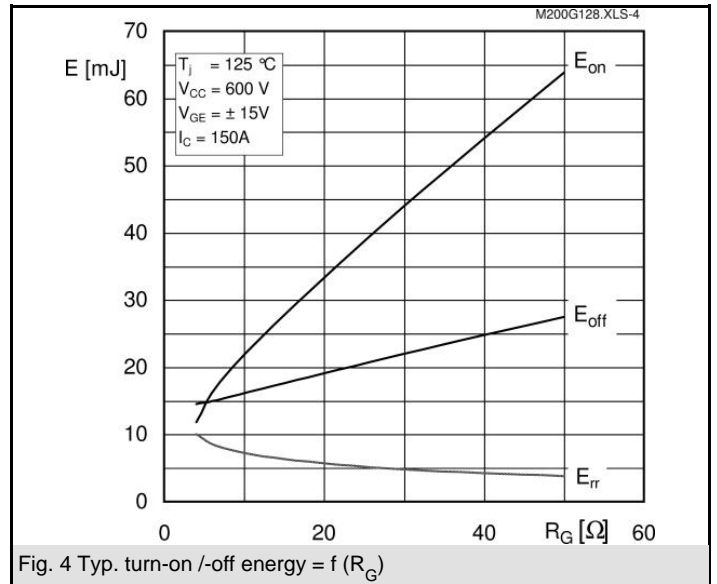
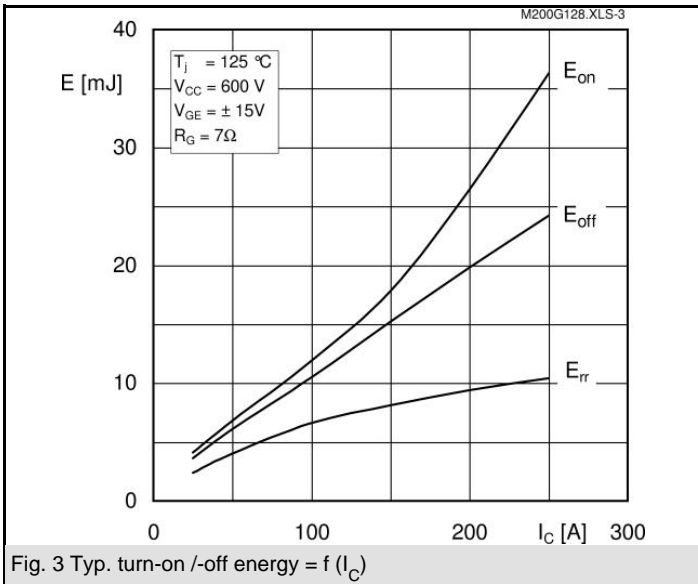
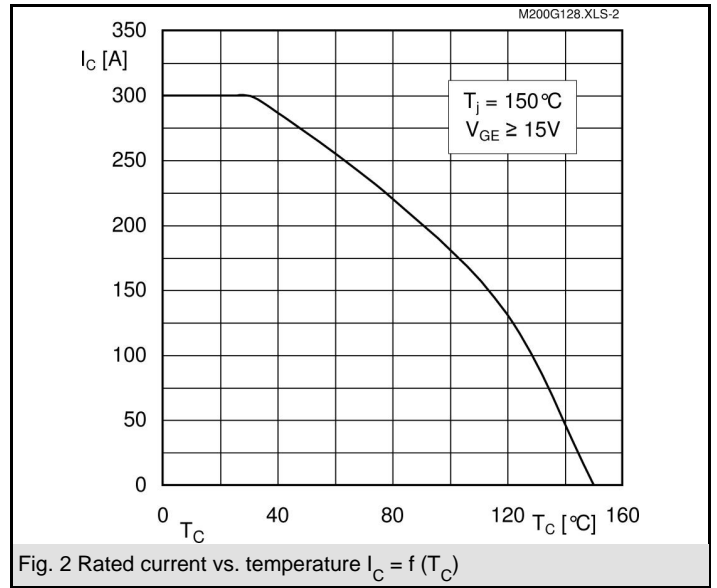
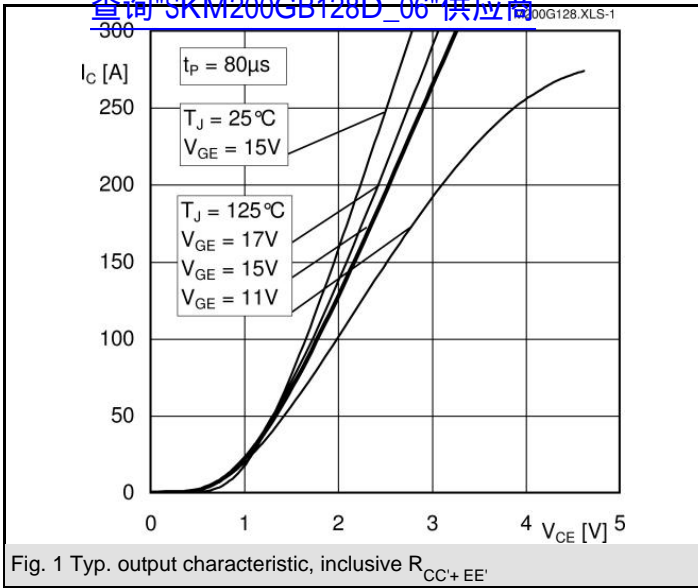

查询"SKM200GB128D_06"供应商

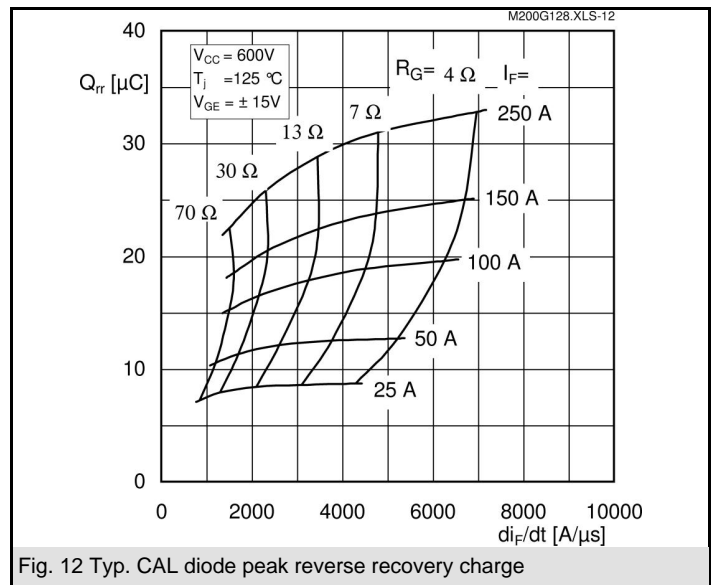
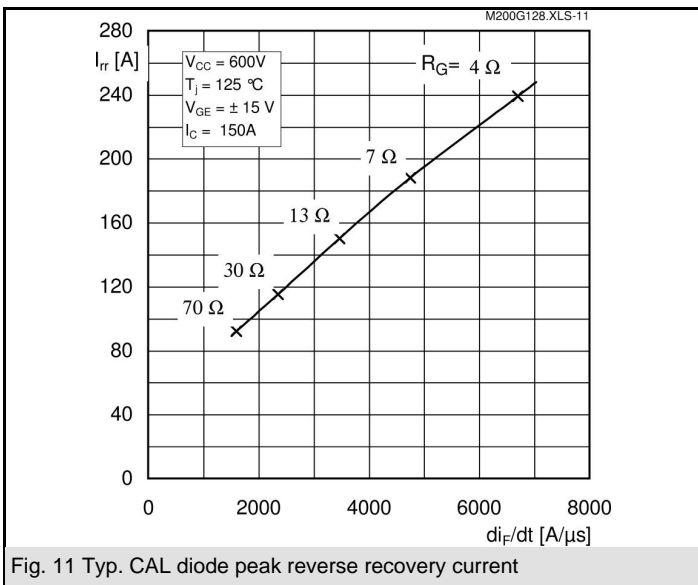
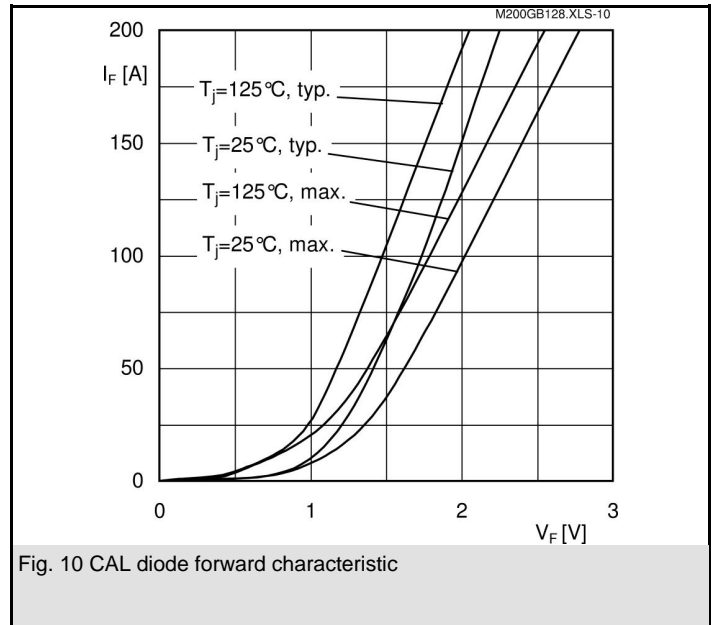
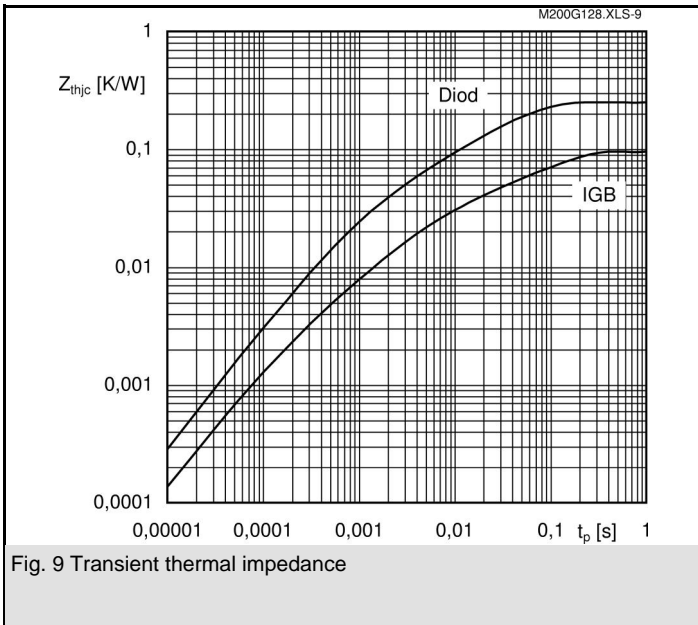
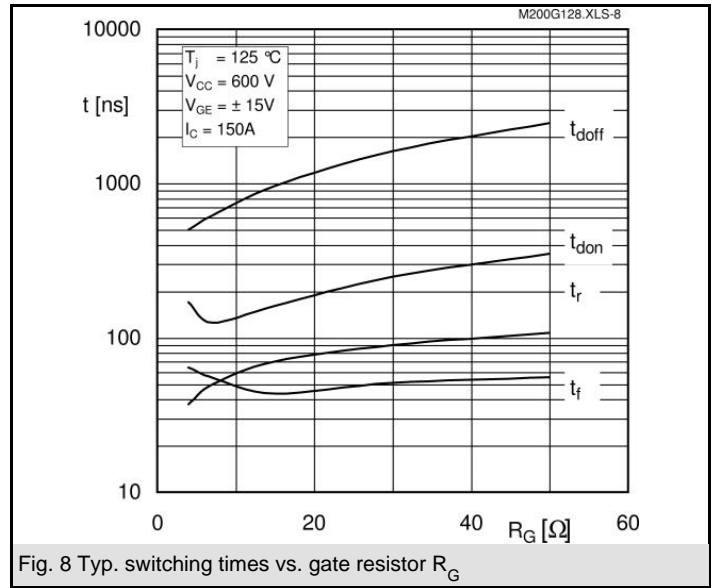
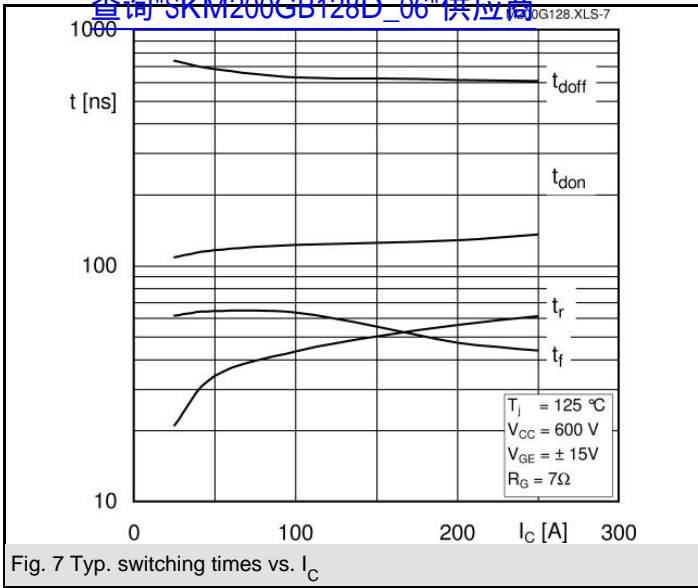

SKM 200GB128D

UL Recognized [查询"SKM200GB128D_06"供应商](#)

CASED56

File no. 63 532

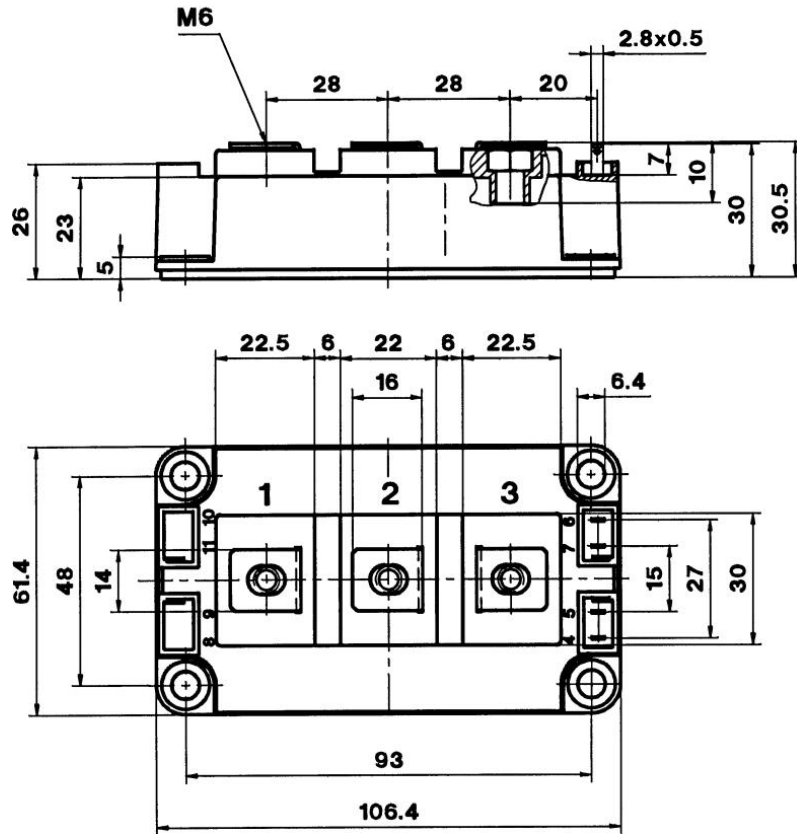

Case D 56

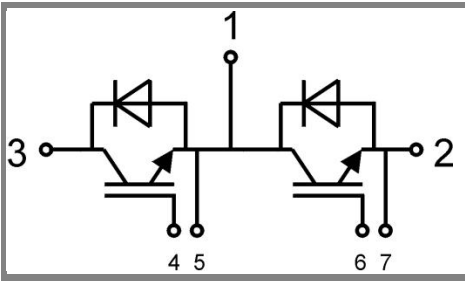

GB

Case D 56