

1-of-8 decoder/demultiplexer

74F138

[查询"54F138/B2A"供应商](#)

FEATURE

- Demultiplexing capability
- Multiple input enable for easy expansion
- Ideal for memory chip select decoding
- Industrial temperature range available (-40°C to $+85^{\circ}\text{C}$)

DESCRIPTION

The 74F138 decoder accepts three binary weighted inputs (A0, A1, A2) and when enabled, provides eight mutually exclusive, active low outputs ($\overline{Q}0 - \overline{Q}7$). The device features three enable inputs; two active low (E0, E1) and one active high (E2). Every output will be high unless E0 and $\overline{E}1$ are low and E2 is high. This multiple enable function allows easy parallel expansion of the device to 1-of-32 (5 lines to 32 lines) decoder with just four 74F138s and one inverter (see Fig. 1). The device can be used as an eight output demultiplexer by using one of the active low enable inputs as the data input and the remaining enable inputs as strobes. Enable inputs not used must be permanently tied to their appropriate active high or active low state.

TYPE	TYPICAL PROPAGATION DELAY	TYPICAL SUPPLY CURRENT(TOTAL)
74F138	5.8ns	13mA

ORDERING INFORMATION

DESCRIPTION	ORDER CODE	
	COMMERCIAL RANGE $V_{CC} = 5V \pm 10\%$, $T_{amb} = 0^{\circ}\text{C}$ to $+70^{\circ}\text{C}$	INDUSTRIAL RANGE $V_{CC} = 5V \pm 10\%$, $T_{amb} = -40^{\circ}\text{C}$ to $+85^{\circ}\text{C}$
16-pin plastic DIP	N74F138N	I74F138N
16-pin plastic SO	N74F138D	I74F138D

INPUT AND OUTPUT LOADING AND FAN OUT TABLE

PINS	DESCRIPTION	74F (U.L.) HIGH/LOW	LOAD VALUE HIGH/LOW
A0 - A2	Address inputs	1.0/1.0	20 μ A/0.6mA
$\overline{E}0, \overline{E}1$	Enable inputs (active low)	1.0/1.0	20 μ A/0.6mA
E2	Enable input (active high)	1.0/1.0	20 μ A/0.6mA
$\overline{Q}0 - \overline{Q}7$	Data outputs	50/33	1.0mA/20mA

Note to input and output loading and fan out table

1. One (1.0) FAST unit load is defined as: 20 μ A in the high state and 0.6mA in the low state.

PIN CONFIGURATION

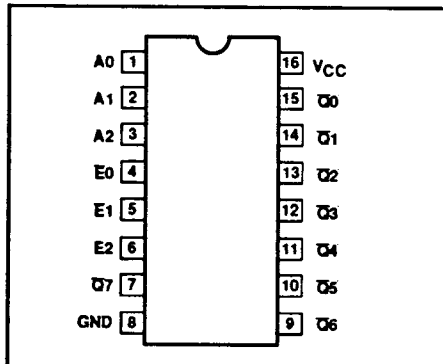

LOGIC SYMBOL

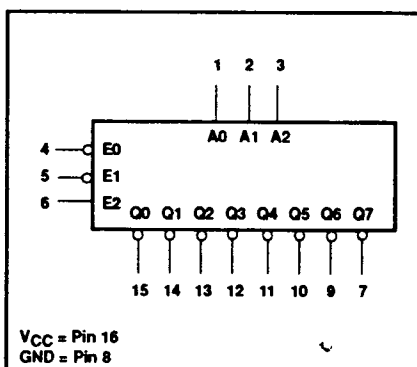

IEC/IEEE SYMBOL

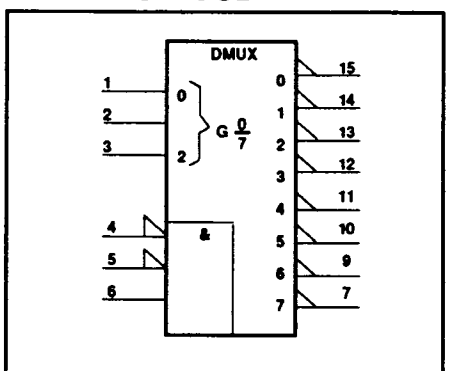

1-of-8 decoder/demultiplexer

74F138

[查询"54F138/B2A"供应商](#)

LOGIC DIAGRAM

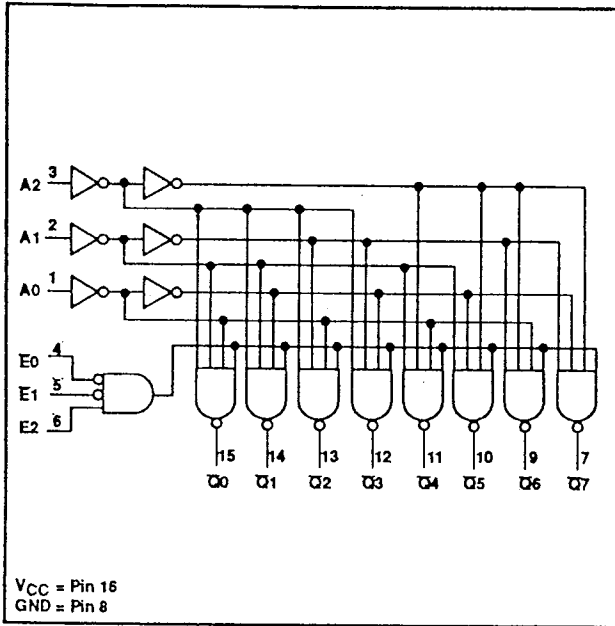

FUNCTION TABLE

INPUTS						OUTPUTS							
E0	E1	E2	A0	A1	A2	Q0	Q1	Q2	Q3	Q4	Q5	Q6	Q7
H	X	X	X	X	X	H	H	H	H	H	H	H	H
X	H	X	X	X	X	H	H	H	H	H	H	H	H
X	X	L	X	X	X	H	H	H	H	H	H	H	H
L	L	H	L	L	L	L	H	H	H	H	H	H	H
L	L	H	H	L	L	H	L	H	H	H	H	H	H
L	L	H	L	H	L	H	H	L	H	H	H	H	H
L	L	H	H	H	L	H	H	H	L	H	H	H	H
L	L	H	L	L	H	H	H	H	H	L	H	H	H
L	L	H	H	L	H	H	H	H	H	H	L	H	H
L	L	H	L	H	H	H	H	H	H	H	H	L	H
L	L	H	H	H	H	H	H	H	H	H	H	H	L

Notes to function table

1. H = High voltage level
2. L = Low voltage level
3. X = Don't care

APPLICATION

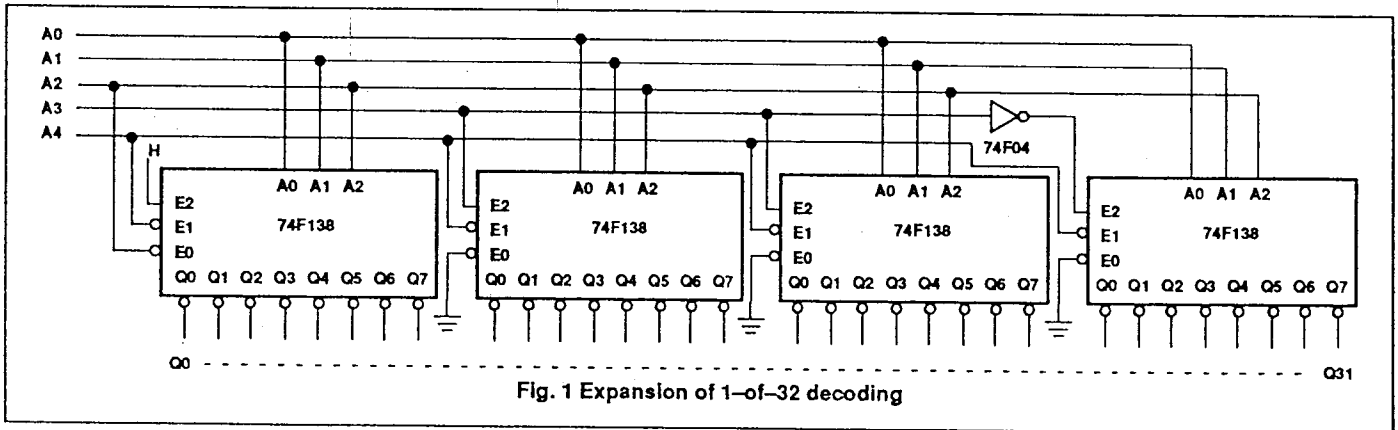

ABSOLUTE MAXIMUM RATINGS

(Operation beyond the limit set forth in this table may impair the useful life of the device. Unless otherwise noted these limits are over the operating free air temperature range.)

SYMBOL	PARAMETER	RATING	UNIT
V _{CC}	Supply voltage	-0.5 to +7.0	V
V _{IN}	Input voltage	-0.5 to +7.0	V
I _{IN}	Input current	-30 to +5	mA
V _{OUT}	Voltage applied to output in high output state	-0.5 to V _{CC}	V
I _{OUT}	Current applied to output in low output state	40	mA
T _{amb}	Operating free air temperature range	Commercial range	0 to +70 °C
		Industrial range	-40 to +85 °C
T _{stg}	Storage temperature range	-65 to +150	°C

[查询"54F138/B2A"供应商](#)

RECOMMENDED OPERATING CONDITIONS

SYMBOL	PARAMETER	LIMITS			UNIT
		MIN	NOM	MAX	
V_{CC}	Supply voltage	4.5	5.0	5.5	V
V_{IH}	High-level input voltage	2.0			V
V_{IL}	Low-level input voltage			0.8	V
I_{IK}	Input clamp current			-18	mA
I_{OH}	High-level output current			-1	mA
I_{OL}	Low-level output current			20	mA
T_{amb}	Operating free air temperature range	Commercial range	0	+70	°C
		Industrial range	-40	+85	°C

DC ELECTRICAL CHARACTERISTICS

(Over recommended operating free-air temperature range unless otherwise noted.)

SYMBOL	PARAMETER	TEST CONDITIONS ¹		LIMITS			UNIT	
				MIN	TYP ²	MAX		
V_{OH}	High-level output voltage	$V_{CC} = \text{MIN}, V_{IL} = \text{MAX},$ $V_{IH} = \text{MIN}$	$I_{OH} = \text{MAX}$	$\pm 10\%V_{CC}$	2.5		V	
				$\pm 5\%V_{CC}$	2.7	3.4	V	
V_{OL}	Low-level output voltage	$V_{CC} = \text{MIN}, V_{IL} = \text{MAX},$ $V_{IH} = \text{MIN}$	$I_{OL} = \text{MAX}$	$\pm 10\%V_{CC}$		0.30	0.50	V
				$\pm 5\%V_{CC}$		0.30	0.50	V
V_{IK}	Input clamp voltage	$V_{CC} = \text{MIN}, I_I = I_{IK}$			-0.73	-1.2	V	
I_I	Input current at maximum input voltage	$V_{CC} = \text{MAX}, V_I = 7.0\text{V}$				100	μA	
I_{IH}	High-level input current	$V_{CC} = \text{MAX}, V_I = 2.7\text{V}$				20	μA	
I_{IL}	Low-level input current	$V_{CC} = \text{MAX}, V_I = 0.5\text{V}$				-0.6	mA	
I_{OS}	Short-circuit output current ³	$V_{CC} = \text{MAX}$			-60	-150	mA	
I_{CC}	Supply current ⁴ (total)	$V_{CC} = \text{MAX}$			13	20	mA	

Notes to DC electrical characteristics

- For conditions shown as MIN or MAX, use the appropriate value specified under recommended operating conditions for the applicable type.
- All typical values are at $V_{CC} = 5\text{V}, T_{amb} = 25^\circ\text{C}$.
- Not more than one output should be shorted at a time. For testing I_{OS} , the use of high-speed test apparatus and/or sample-and-hold techniques are preferable in order to minimize internal heating and more accurately reflect operational values. Otherwise, prolonged shorting of a high output may raise the chip temperature well above normal and thereby cause invalid readings in other parameter tests. In any sequence of parameter tests, I_{OS} tests should be performed last.
- To measure I_{CC} , outputs must be open, V_{IN} on all inputs = 4.5V.

AC ELECTRICAL CHARACTERISTICS

SYMBOL	PARAMETER	TEST CONDITION	LIMITS						UNIT	
			$T_{amb} = +25^\circ\text{C}$ $V_{CC} = +5.0\text{V}$ $C_L = 50\text{pF},$ $R_L = 500\Omega$			$T_{amb} = 0^\circ\text{C to } +70^\circ\text{C}$ $V_{CC} = +5.0\text{V} \pm 10\%$ $C_L = 50\text{pF},$ $R_L = 500\Omega$		$T_{amb} = -40^\circ\text{C to } +85^\circ\text{C}$ $V_{CC} = +5.0\text{V} \pm 10\%$ $C_L = 50\text{pF},$ $R_L = 500\Omega$		
			MIN	TYP	MAX	MIN	MAX	MIN		MAX
t_{PLH} t_{PHL}	Propagation delay An to \bar{Q}_n	Waveform 1, 2	3.5 4.0	5.6 6.1	7.0 8.0	3.5 4.0	8.0 9.0	3.0 3.5	8.5 9.0	ns
t_{PLH} t_{PHL}	Propagation delay E0 or $\bar{E}1$ to \bar{Q}_n	Waveform 2	3.5 3.0	6.4 5.3	7.0 7.0	3.5 3.0	8.0 7.5	3.0 3.0	8.0 7.5	ns
t_{PLH} t_{PHL}	Propagation delay E2 to \bar{Q}_n	Waveform 1	4.0 3.5	6.2 5.6	8.0 7.5	4.0 3.5	9.0 8.5	4.0 3.5	9.5 8.5	ns

[查询"54F138/B2A"供应商](#)

AC WAVEFORMS

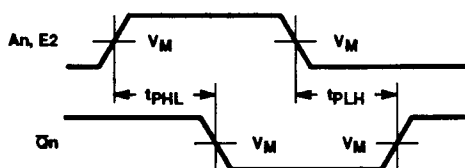

Waveform 1. Propagation delay for inverting outputs

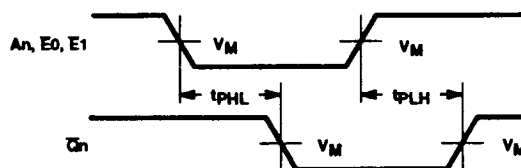

Waveform 2. Propagation delay for non-inverting outputs

Note to AC waveforms

1. For all waveforms, $V_M = 1.5V$.

TEST CIRCUIT AND WAVEFORMS

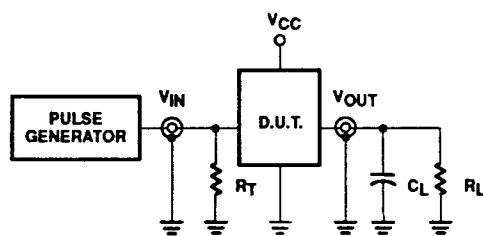

Test circuit for totem-pole outputs

DEFINITIONS:

- R_L = Load resistor; see AC electrical characteristics for value.
- C_L = Load capacitance includes jig and probe capacitance; see AC electrical characteristics for value.
- R_T = Termination resistance should be equal to Z_{OUT} of pulse generators.

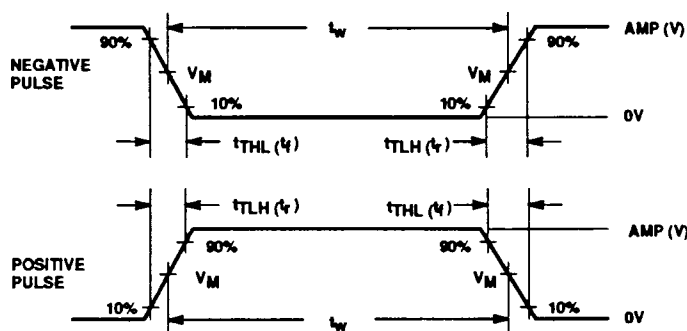

Input pulse definition

family	INPUT PULSE REQUIREMENTS					
	amplitude	v_M	rep. rate	t_w	t_{TLH}	t_{THL}
74F	3.0V	1.5V	1MHz	500ns	2.5ns	2.5ns

VI. COMMERCIAL PRODUCT SPECIAL PROCESSING T-90-20

SUPR II LEVEL B PRICING ADDERS

[查询"54F138/B2A"供应商](#)

SUPR II LEVEL B

Signetics Upgraded Product Reliability (SUPR) program is designed to provide customers whose systems require an infant mortality level less than that of our non-burned-in products (which is typically below 1000 PPM).

DEVICE AVAILABILITY

Products available for Level B processing are identified in the Price Book with a "B" suffix to the basic part number.

PRODUCT FAMILY	SUGGESTED RESALE ADDERS		
	1-99	100-999	OVER 1000
LIN	.14	.14	.11
LOG (TTL)			
(SS1)	.12	.10	.08
(MS1)	.16	.14	.11
(OCT)	.16	.14	.11
(CTM)	.16	.14	.11
LOG (ECL)			
(SS1)	.25	.23	.20
(MS1)	.25	.23	.20
LOG (LSI)	Consult Factory for Pricing		
(RAM)			
MIC (8X)	Consult Factory for Pricing		
PLD			
MCG	Consult Factory for Pricing		
DAT	Not Available		
MIC			

MARKING FORMAT EXAMPLES

Standard (no Burn-In) Products (Dual-in-line)

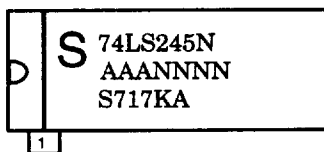

SUPR II (Burned-In) Products (Dual-in-line)

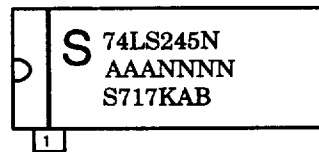

NOTE: The "B" in the 7th position on the 3rd line, when present, is the SUPR II Burn-In indicator.

TAPE AND REEL PACKAGING

SPECIFICATIONS

Tape and Reel specifications conform to Electronic Industries Association (EIA) Proposed Specification #EIA-481-A using 13 inch reels. Current incremental quantities reflect the quantities per reel. As more customers are able to handle a larger quantity per reel, this quantity will be increased.

DEVICE AVAILABILITY

Products available in tape and reel packaging are identified in the Price Book with a "T" suffix to the basic part number and are only offered as a product for sale by the reel. Return of product is limited to full reels with unbroken quality seals.

TAPE AND REEL PRICING ADDERS

PRODUCT FAMILY	SUGGESTED RESALE ADDER
MCG	.07
LIN	.07
LOG	.07
DAT	PACKAGE A28 = .20 A44 = .25 A52 = .30 A68 = .40 A84 = .45 D24 = .17
MIC	

VII. PACKING QUANTITY INFORMATION

T-90-20

CERAMIC DUAL IN-LINE (CERDIP)

PACKAGE CODE	PIN COUNT	QUANTITIES	
		DEVICES PER TUBE	DEVICES PER BOX
F/FE, BPA, PA	8-pin (300-mil)	48	1920
F, BCA, CA	14-pin (300-mil)	25	1000
F, BEA, EA	16-pin (300-mil)	25	1000
F, BVA, MVA	18-pin (300-mil)	21	840
F/FA, BRA, RA	20-pin (300-mil)	20	800
F, BWA, WA	22-pin (400-mil)	17	544
F/FA/F6, BJA, JA	24-pin (600-mil)	15	360
F/FA/F3/F24, BLA, LA	24-pin (300-mil)	15	600
F, BXA, XA	24-pin (400-mil)	15	480
F/FA/F28, BXA, XA	28-pin (600-mil)	13	312
FA	32-pin (600-mil)	11	264
F/FA/F40, BQA, MQA, QA	40-pin (600-mil)	9	216

CERPAC

PACKAGE CODE	PIN COUNT	QUANTITIES
		DEVICES PER TUBE
BDA/DAW	14-pin	145
BFA/FAW	16-pin	145
BXA/BYAW	18-pin	100
BSA/SAW/WB	20-pin	100
BKA/KAW	24-pin	120
BYA/YAW	28-pin	50

CERQUAD

PACKAGE CODE	PIN COUNT	QUANTITIES	
		DEVICES PER TRAY	DEVICES PER BOX
KA/K44	44-pin	6	6
KA/K68	68-pin	4	4
KA	84-pin	42	210

LEADLESS CHIP CARRIER

PACKAGE CODE	PIN COUNT	QUANTITIES
		DEVICES PER TUBE
B2A/2A/GA	20-pin	55
B3A/3A/GA/GC1	28-pin	43
YA/YA/GC2	32-pin	35
BUA/MXA/MUA/UA/XA/GA/GC	44-pin	27
BZA/BUA/UA/ZA/GA/GC	68-pin	19

QUANTITIES SHOWN IN GRAY REQUIRE PURCHASE TO BE MADE IN EXACT MULTIPLES OF THAT QUANTITY.

VII. PACKING QUANTITY INFORMATION

T-90-20

PLASTIC DUAL IN-LINE

查询"54F138/B2A"供应商 PACKAGE CODE	PIN COUNT	QUANTITIES	
		DEVICES PER TUBE	DEVICES PER BOX
N/N8	8-pin (300-mil)	50	2000
N/N14/N16	14- 16-pin (300-mil)	25	1000
N	18-pin (300-mil)	20	800
N/N20	20-pin (300-mil)	18	720
N	22-pin (400-mil)	17	544
N/N6	24-pin (600-mil)	15	360
N/N3/N24	24-pin (300-mil)	15	600
N/N24	24-pin (400-mil)	15	480
N/N28	28-pin (600-mil)	13	312
N/N3	28-pin (300-mil)	13	520
N	32-pin (600-mil)	11	264
N/N40	40-pin (600-mil)	9	216
NB (Shrink)	42-pin (600-mil)	12	288
N/N48	48-pin (600-mil)	7	168
N	50-pin (900-mil)	7	112
N/N64	64-pin (900-mil)	5	80

PLASTIC LEADED CHIP CARRIER (PLCC)

PACKAGE CODE	PIN COUNT	QUANTITIES		
		DEVICES PER TUBE	DEVICES PER BOX	DEVICES PER REEL
A	20-pin	46	3680	1000
A/A28	28-pin	37	2368	750
A	32-pin	31	2232	750
A/A44	44-pin	26	1248	500
A/A52	52-pin	23	1012	500
A/A68	68-pin	18	648	250
A/A84	84-pin	15	420	250

QUANTITIES SHOWN IN GRAY REQUIRE PURCHASE TO BE MADE IN EXACT MULTIPLES OF THAT QUANTITY.

VII. PACKING QUANTITY INFORMATION

T-90-20

PLASTIC SMALL OUTLINE (SO)

查询"54F138/B2A"供应商 PACKAGE CODE	PIN COUNT	QUANTITIES		
		DEVICES PER TUBE	DEVICES PER BOX	DEVICES PER REEL
D/D8	8-pin (150-mil)	100	10000	2500
D	8-pin (300-mil)	64	2560	1000 - 13" 700 - 7"
D/D14	14-pin (150-mil)	57	5700	2500
D	16-pin (150-mil)	50	5000	2500
D	16-pin (300-mil)	48	1920	1000
DK(SSOP)	20-pin (170-mil)	75	6750	2500
D	20-pin (300-mil)	38	1520	1000
D/D24	24-pin (300-mil)	32	1280	1000
D	28-pin (300-mil)	27	1080	1000
D	40-pin (VSO-40)	31	1240	1000 - 13" 300 - 7"
D	56-pin (VSO-56)	22	616	1000

QUAD FLAT PACK*

PACKAGE CODE	PIN COUNT	QUANTITIES	
		DEVICES PER TRAY	DEVICES PER BOX
B/B44	44-pin	50	500
B/B44	44-pin	96	480
B	52-pin	119	595
B	80-pin	66	330
B	100-pin	50	250
B	120-pin	24	120
B	120-pin (Philips source)	30	150

* Quad Flat Pack parts require dry pack handling according to EIA Standard - 583.
 These parts are identified in part list section with DRY PACK in the Cross Ref Part No field.

QUANTITIES SHOWN IN GRAY REQUIRE PURCHASE TO BE MADE IN EXACT MULTIPLES OF THAT QUANTITY.