

# BUK1M200-50SGTD

Quad channel logic level TOPFET

Rev. 01 — 31 March 2003

Product data

## 1. Product profile

### 1.1 Description

Quad temperature and overload protected power switch based on TOPFET™ Trench technology in a 20-pin surface mount plastic package.

Product availability:

BUK1M200-50SGTD in SOT163-1 (SO20).

### 1.2 Features

- Power TrenchMOS™
- Overtemperature protection
- Overload protection
- Input-source voltage resets latched protection circuitry.
- Control of output stage and supply of overload protection circuits derived from input
- 5V logic compatible
- Current trip protection
- ESD protection for all pins
- Overvoltage clamping for turn off of inductive loads
- Low operating input current permits direct drive by micro-controller.

### 1.3 Applications

- Low-side driver
- Pulse Width Modulation
- DC switching
- General purpose switch for driving lamps, motors, solenoids and heaters.

### 1.4 Quick reference data

Table 1: Quick reference data

Symbol	Parameter	Min	Max	Unit
$R_{DSon}$	drain-source on-state resistance	-	200	mΩ
$I_D$	drain current	-	2.7	A
$P_{tot}$	total power dissipation	[1]	9.4	W
$T_j$	junction temperature	-	150	°C
$V_{DS}$	drain-source voltage	-	50	V

[1] All devices active.



PHILIPS

## 2. Pinning information

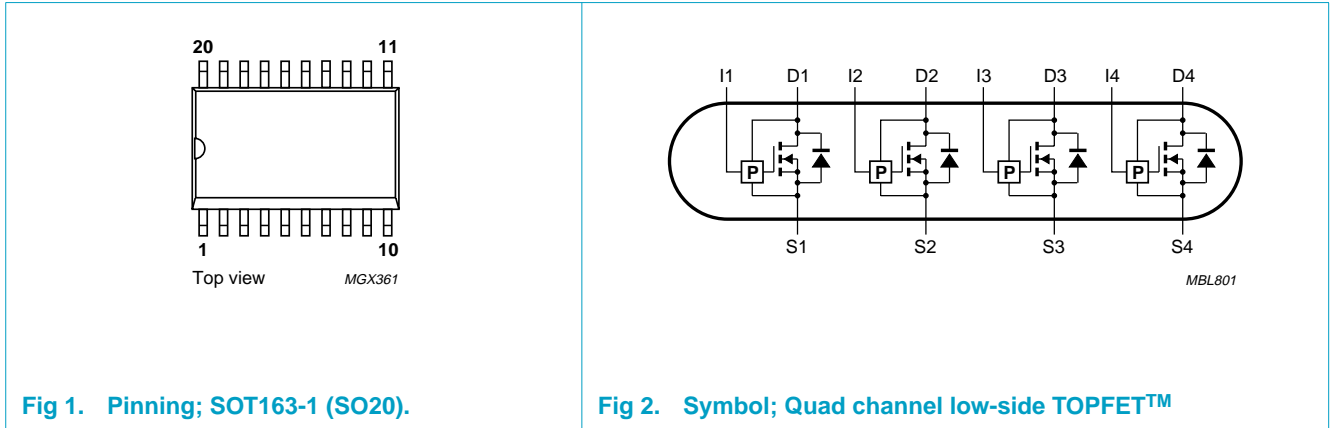


Fig 1. Pinning; SOT163-1 (SO20).

Fig 2. Symbol; Quad channel low-side TOPFET™

### 2.1 Pin description

Table 2: Pin description

Symbol	Pin	Description
n.c.	1, 11, 10, 20	not connected
D1	2,19	drain 1
I1	3	input 1
D2	4,17	drain 2
I2	5	input 2
D3	6,15	drain 3
I3	7	input 3
D4	8, 13	drain 4
I4	9	input 4
S4	12	source 4
S3	14	source 3
S2	16	source 2
S1	18	source 1

## 3. Block diagram

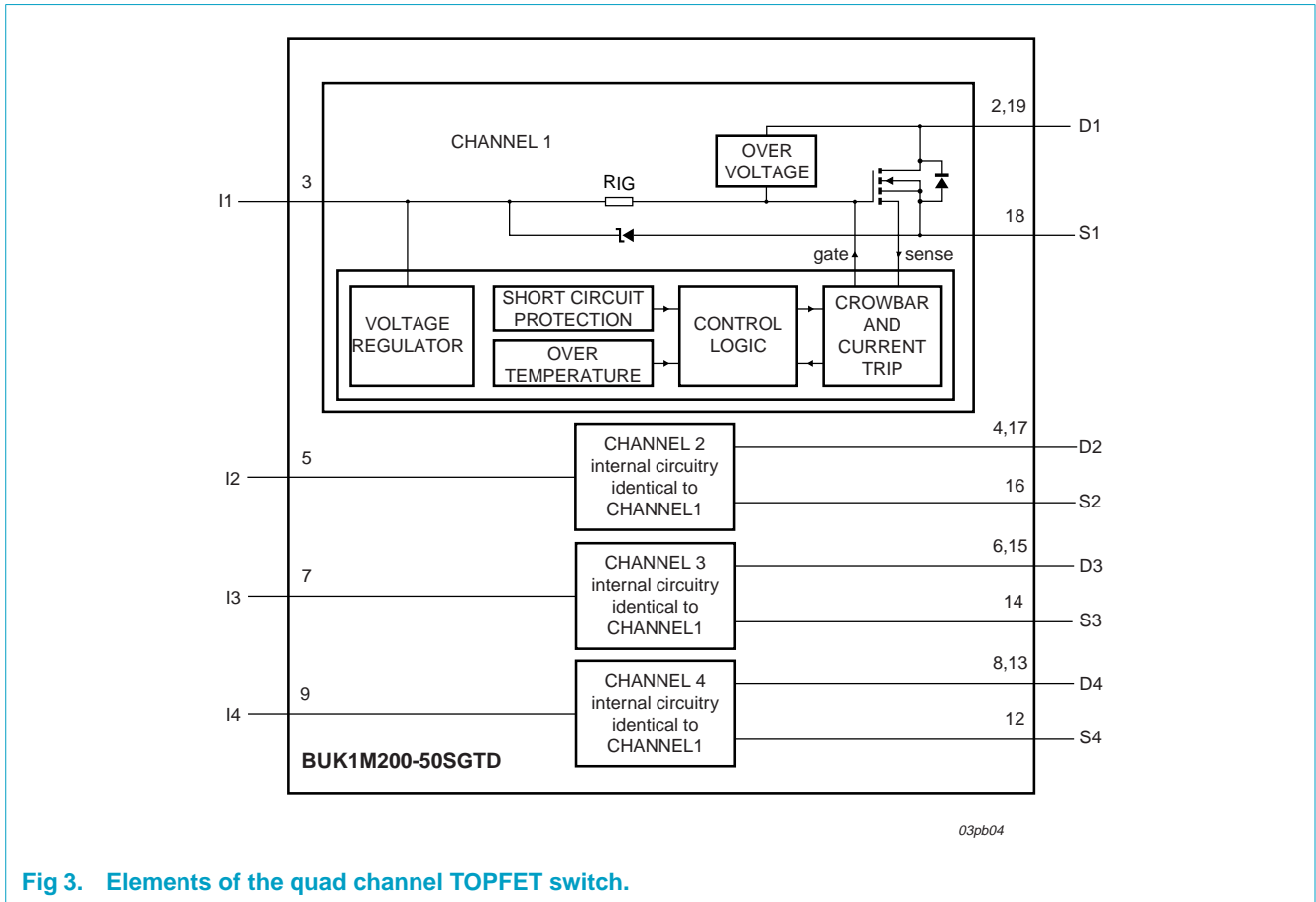


Fig 3. Elements of the quad channel TOPFET switch.

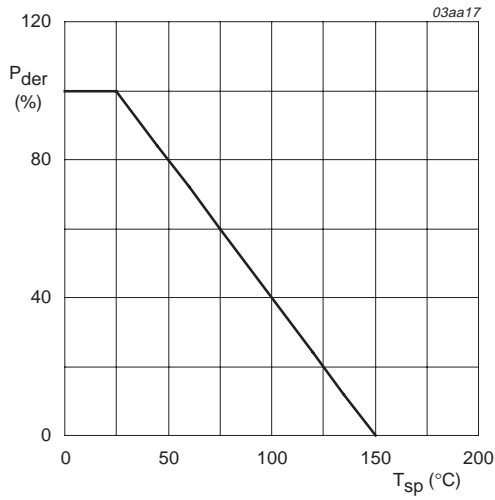
## 4. Limiting values

**Table 3: Limiting values**

In accordance with the Absolute Maximum Rating System (IEC 60134).

Symbol	Parameter	Conditions	Min	Max	Unit
$V_{DS}$	drain-source voltage		[1]	- 50	V
$I_D$	drain current	$T_{sp} = 25\text{ °C}$ ; Figure 5	[2][3]	- 2.7	A
$I_I$	input current	clamping	-	3	mA
$I_{IMS}$	non-repetitive peak input current	$t_p \leq 1\text{ ms}$	-	10	mA
$P_{tot}$	total power dissipation	$T_{sp} = 25\text{ °C}$ ; Figure 4	[4]	- 9.4	W
$T_{stg}$	storage temperature		-55	+150	°C
$T_j$	junction temperature	normal operation	[5]	- 150	°C
<b>Overvoltage clamping [6]</b>					
$E_{DS(CL)S}$	non-repetitive drain-source clamping energy	$T_{amb} = 25\text{ °C}$ ; $I_{DM} \leq I_{D(th)(trip)}$ ; inductive load	[3]	- 100	mJ
$E_{DS(CL)R}$	repetitive drain-source clamping energy	$T_{sp} \leq 125\text{ °C}$ ; $I_{DM} = 1\text{ A}$ ; $f = 250\text{ Hz}$	[3]	- 5	mJ
<b>Overload protection [7]</b>					
$V_{DS(prot)}$	protected drain-source voltage	$V_{IS} \geq 4\text{ V}$	-	35	V
<b>Reverse diode</b>					
$I_S$	source (diode forward) current	$T_{sp} \leq 25\text{ °C}$ ; $V_{IS} = 0\text{ V}$	-	2	A
<b>Electrostatic discharge</b>					
$V_{esd}$	electrostatic discharge voltage	$C = 250\text{ pF}$ ; $R = 1.5\text{ k}\Omega$	-	2	kV

- [1] Prior to the onset of overvoltage clamping. For voltages above this value, safe operation is limited by the overvoltage clamping energy.
- [2] Refer to overload protection characteristics in Table 5.
- [3] For a single active device.
- [4] For all devices active.
- [5] Not in an overload condition with drain current limiting.
- [6] At a drain-source voltage above 50 V the power MOSFET is actively turned on to clamp overvoltage transients.
- [7] With the protection supply provided via the input pin, the TOPFET is protected from short circuit loads. Overload protection operates by means of drain current trip or by activating the overtemperature protection.



$$P_{der} = \frac{P_{tot}}{P_{tot(25^{\circ}C)}} \times 100\%$$

Fig 4. Normalized total power dissipation as a function of solder point temperature.

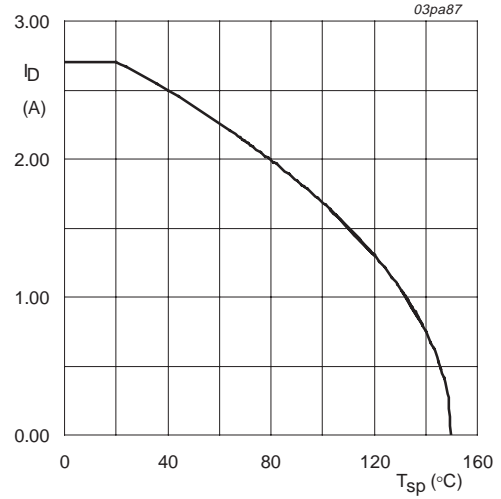


Fig 5. Continuous drain current as a function of solder point temperature.

## 5. Thermal characteristics

Table 4: Thermal characteristics

Symbol	Parameter	Conditions	Min	Typ	Max	Unit
R <sub>th(j-sp)</sub>	thermal resistance from junction to solder point.	mounted on thermo clad board				
		one device active	-	-	45	K/W
		all devices active	-	-	13.3	K/W

## 6. Static characteristics

**Table 5: Static characteristics**

Limits are valid for  $-40\text{ }^{\circ}\text{C} \leq T_{sp} \leq +150\text{ }^{\circ}\text{C}$  and typical values for  $T_{sp} = 25\text{ }^{\circ}\text{C}$  unless otherwise specified.

Symbol	Parameter	Conditions	Min	Typ	Max	Unit	
<b>Off-state output characteristics</b>							
$V_{DS(CL)}$	drain-source clamping voltage	$V_{IS} = 0\text{ V}; I_D = 10\text{ mA}$	50	-	-	V	
		$V_{IS} = 0\text{ V}; I_D = 200\text{ mA}; t_p \leq 300\text{ }\mu\text{s}; \delta \leq 0.01$ ; <b>Figure 18</b>	50	62	70	V	
$I_{DSS}$	drain-source leakage current	$V_{IS} = 0\text{ V}; V_{DS} = 40\text{ V}$	-	-	100	$\mu\text{A}$	
		$T_{sp} = 25\text{ }^{\circ}\text{C}$ ; <b>Figure 19</b>	-	0.05	10	$\mu\text{A}$	
<b>On-state output characteristic</b>							
$R_{DS(on)}$	drain-source on-state resistance	$V_{IS} \geq 4\text{ V}; t_p \leq 300\text{ }\mu\text{s}; \delta \leq 0.01$ ; $I_D = 100\text{ mA}$	-	-	380	$\text{m}\Omega$	
		$T_{sp} = 25\text{ }^{\circ}\text{C}$ ; <b>Figure 8 and 9</b>	-	150	200	$\text{m}\Omega$	
<b>Input characteristics [1]</b>							
$V_{IS(th)}$	input-source threshold voltage	$V_{DS} = 5\text{ V}; I_D = 1\text{ mA}$	0.6	-	2.4	V	
		$T_{sp} = 25\text{ }^{\circ}\text{C}$ ; <b>Figure 13</b>	1.1	1.6	2.1	V	
$I_{IS}$	input supply current	normal operation					
		$V_{IS} = 5\text{ V}$	100	220	400	$\mu\text{A}$	
		$V_{IS} = 4\text{ V}$	80	195	330	$\mu\text{A}$	
		protection latched					
		$V_{IS} = 5\text{ V}$	1.4	2	2.5	$\text{mA}$	
	$V_{IS} = 3\text{ V}$ ; <b>Figure 14 and 16</b>	0.7	1.1	1.5	$\text{mA}$		
$V_{IS(rst)}$	input-source reset voltage	$t_{rst} \geq 100\text{ }\mu\text{s}$ ; <b>Figure 17</b>	[2]	1.5	2	2.5	V
$t_{rst(latch)}$	latch reset time		[3]	10	40	100	$\mu\text{s}$
$V_{IS(CL)}$	input-source clamping voltage	$I_I = 1.5\text{ mA}$ ; <b>Figure 15</b>		5.5	-	8.5	V
$R_{IG}$	input-gate resistance		[4]	-	2.5	-	$\text{k}\Omega$
<b>Overload protection characteristic [5]</b>							
$I_{D(th)(trip)}$	drain current trip threshold	$4\text{ V} \leq V_{IS} \leq 5.5\text{ V}$					
		$T_{sp} = 25\text{ }^{\circ}\text{C}$ ; <b>Figure 11</b>	4	6.1	8	A	
		<b>Figure 10</b>	3	6.1	9	A	
<b>Overtemperature protection characteristic</b>							
$T_{j(th)}$	threshold junction temperature	$4\text{ V} \leq V_{IS} \leq 5.5\text{ V}$ ; <b>Figure 12</b>	150	170	-	$^{\circ}\text{C}$	
<b>Source drain diode characteristic</b>							
$V_{SD}$	source-drain (diode forward) voltage	$I_S = 2\text{ A}; V_{IS} = 0\text{ V}; t_p = 300\text{ }\mu\text{s}$	-	0.83	1.1	V	

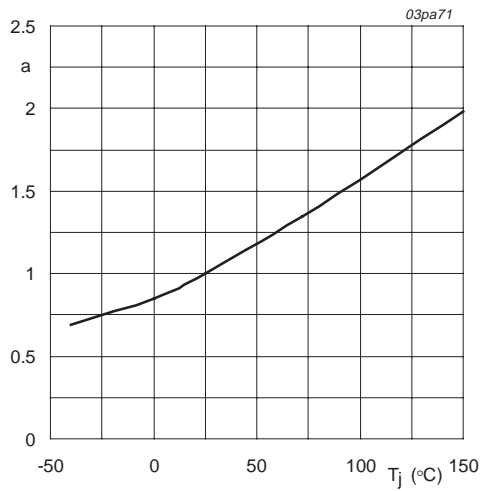
[1] The supply for the logic and overload protection is taken from the input.

[2] The input voltage below which the overload protection circuits will be reset.

[3] To reset the protection circuitry from the latched state,  $V_{IS}$  is reduced from 5 V to 1 V.

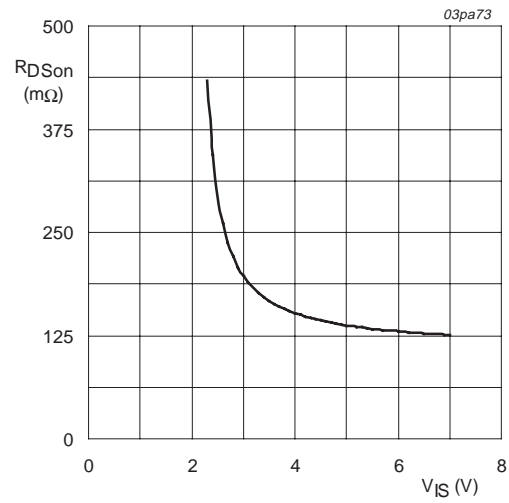
[4] Not directly measurable from device terminals.

[5] The TOPFET switches off to protect itself when one of the overload thresholds is exceeded. It remains latched off until reset by the input.



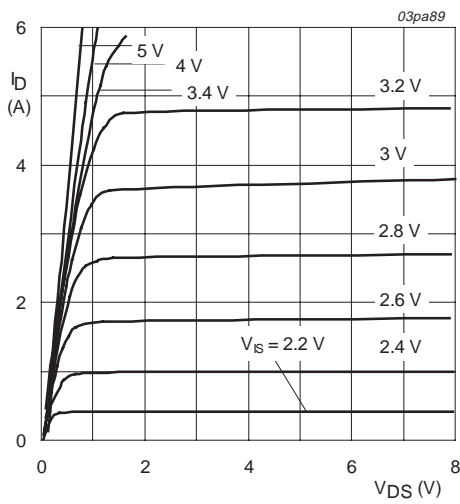
$$a = \frac{R_{DSon}}{R_{DSon(25^{\circ}C)}}$$

**Fig 6. Normalized drain-source on-state resistance factor as a function of junction temperature.**

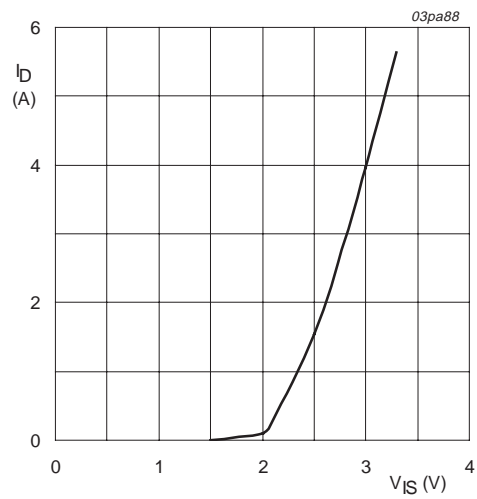


$T_j = 25^{\circ}C; I_D = 100\text{ mA}; t_p = 300\ \mu s$

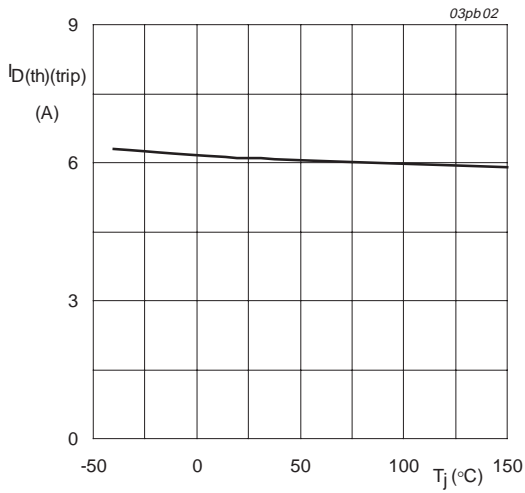
**Fig 7. Drain-source on-state resistance as a function of input-source voltage; typical values.**



**Fig 8. Output characteristics; drain current as a function of drain-source voltage; typical values.**

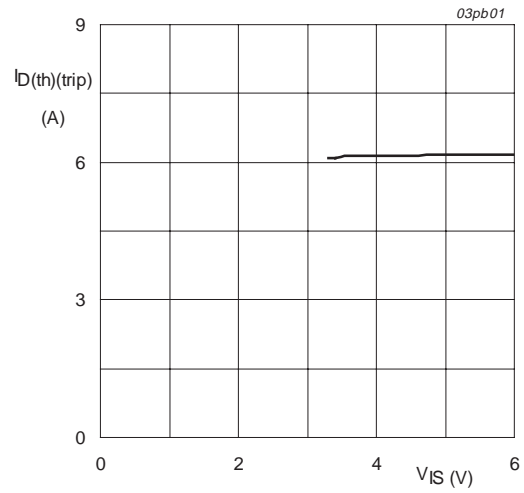


**Fig 9. Transfer characteristics; drain current as a function of input-source voltage; typical values.**



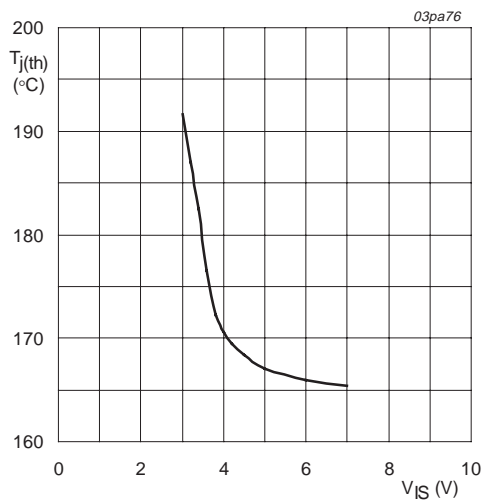
$T_j = 25\text{ °C}$ ;  $t_p = 300\text{ }\mu\text{s}$

**Fig 10. Drain current trip threshold as a function of junction temperature; typical values.**



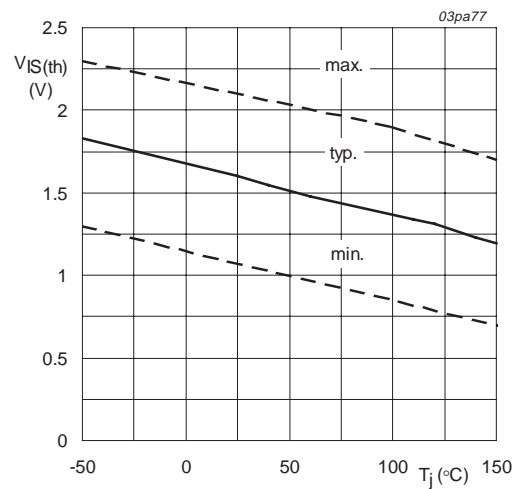
$T_j = 25\text{ °C}$ ;  $V_{DS} = 10\text{ V}$ ;  $t_p = 300\text{ }\mu\text{s}$

**Fig 11. Drain current trip threshold as a function of input-source voltage; typical values.**



$V_{DS} = 5\text{ V}$ ;  $V_{IS} = 5\text{ V}$ ;  $t_p = 300\text{ }\mu\text{s}$

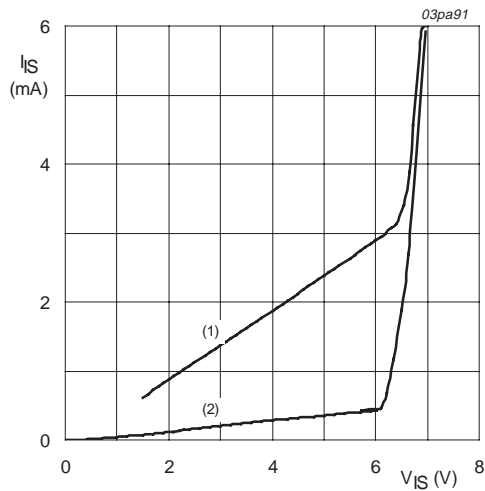
**Fig 12. Overtemperature protection characteristic; threshold junction temperature as a function of input-source voltage; typical values.**



$T_j = 25\text{ °C}$ ;  $V_{DS} = 5\text{ V}$ ;  $t_p = 300\text{ }\mu\text{s}$

**Fig 13. Input-source threshold voltage as a function of junction temperature.**

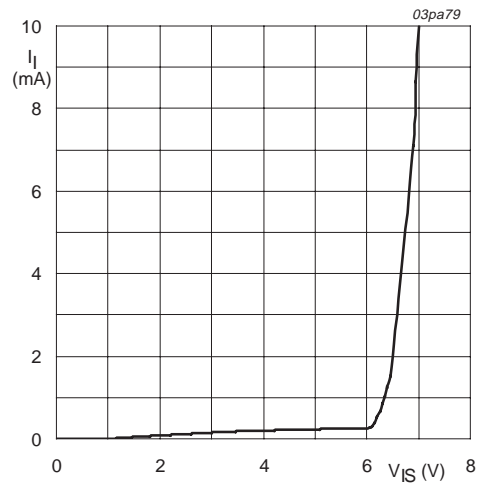




$T_j = 25\text{ }^\circ\text{C}$

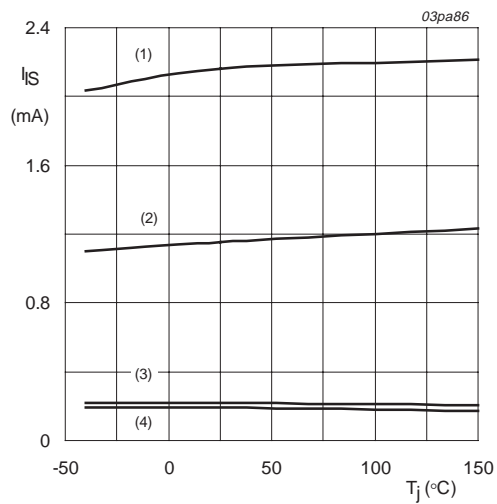
- (1) Input-source current; protection latched.
- (2) Input-source current; normal operation.

**Fig 14. Input-source current as a function of input-source voltage; typical values.**



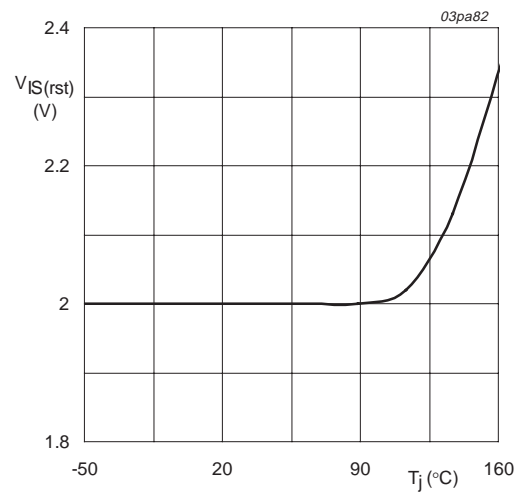
$T_j = 25\text{ }^\circ\text{C}$

**Fig 15. Input clamping characteristic; input current as a function of input-source voltage; typical values.**



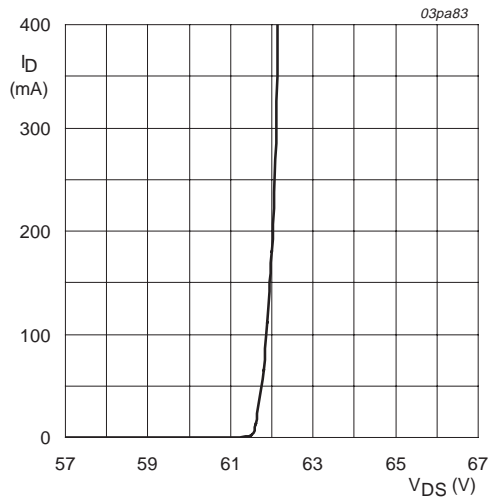
- (1)  $V_{IS} = 5\text{ V}$ ; protection latched
- (2)  $V_{IS} = 3\text{ V}$ ; protection latched
- (3)  $V_{IS} = 5\text{ V}$ ; normal operation
- (4)  $V_{IS} = 4\text{ V}$ ; normal operation

**Fig 16. Input-source current as a function of junction temperature; typical values.**



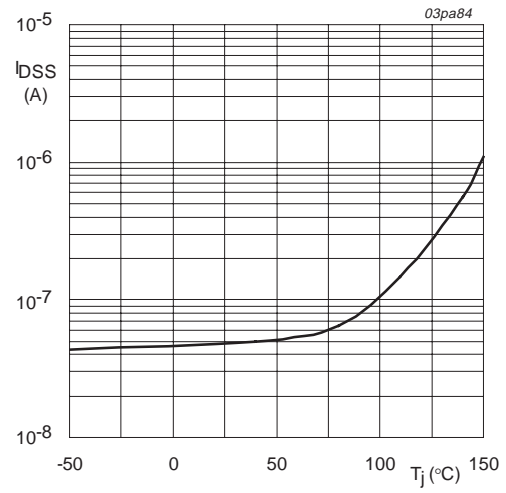
$t_r = 100\text{ }\mu\text{s}$

**Fig 17. Input-source reset voltage as a function of junction temperature; typical values.**



$V_{IS} = 0 \text{ V}; t_p = 300 \mu\text{s}$

**Fig 18. Overvoltage clamping characteristic; drain current as a function of drain-source voltage; typical values.**



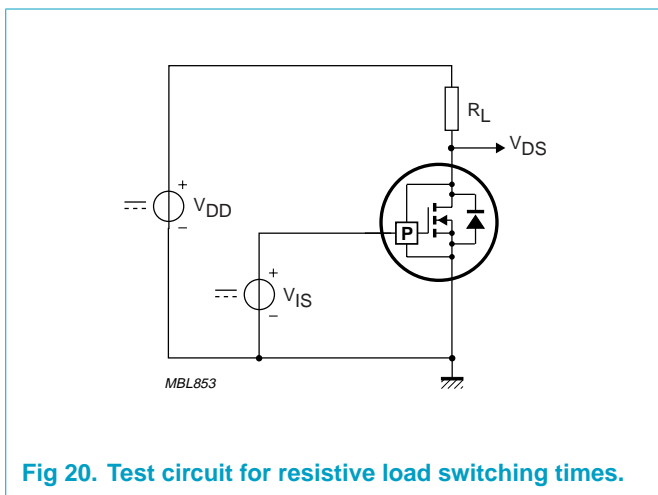
$V_{DS} = 40 \text{ V}; V_{IS} = 0 \text{ V}$

**Fig 19. Drain-source leakage current as a function of junction temperature; typical values.**

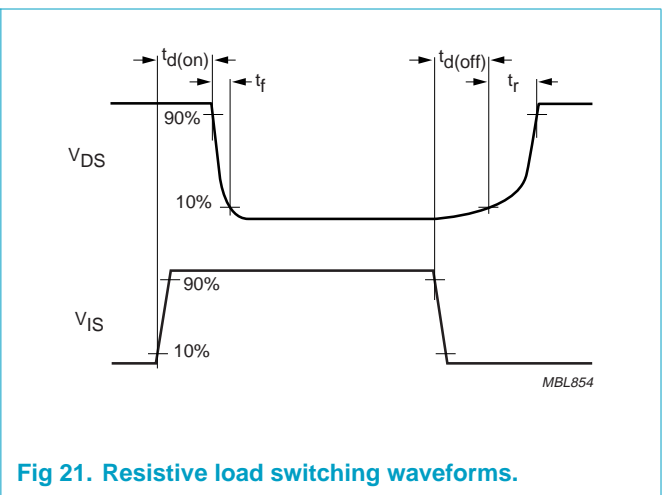
## 7. Dynamic characteristics

**Table 6: Switching characteristics**

Symbol	Parameter	Conditions	Min	Typ	Max	Unit
<b>Switching</b>						
$t_{d(on)}$	turn-on delay time	$R_L = 50 \Omega$ ; $I_D = 250 \text{ mA}$ ; $V_{IS} = 5 \text{ V}$ ;	-	0.5	0.9	$\mu\text{s}$
$t_r$	rise time	$T_{sp} = 25 \text{ }^\circ\text{C}$ ; <b>Figure 20 and 21</b>	-	0.7	1.5	$\mu\text{s}$
$t_{d(off)}$	turn-off delay time		-	3.2	6.5	$\mu\text{s}$
$t_f$	fall time		-	1.6	3.5	$\mu\text{s}$



**Fig 20. Test circuit for resistive load switching times.**



**Fig 21. Resistive load switching waveforms.**

**8. Package outline**

SO20: plastic small outline package; 20 leads; body width 7.5 mm

SOT163-1

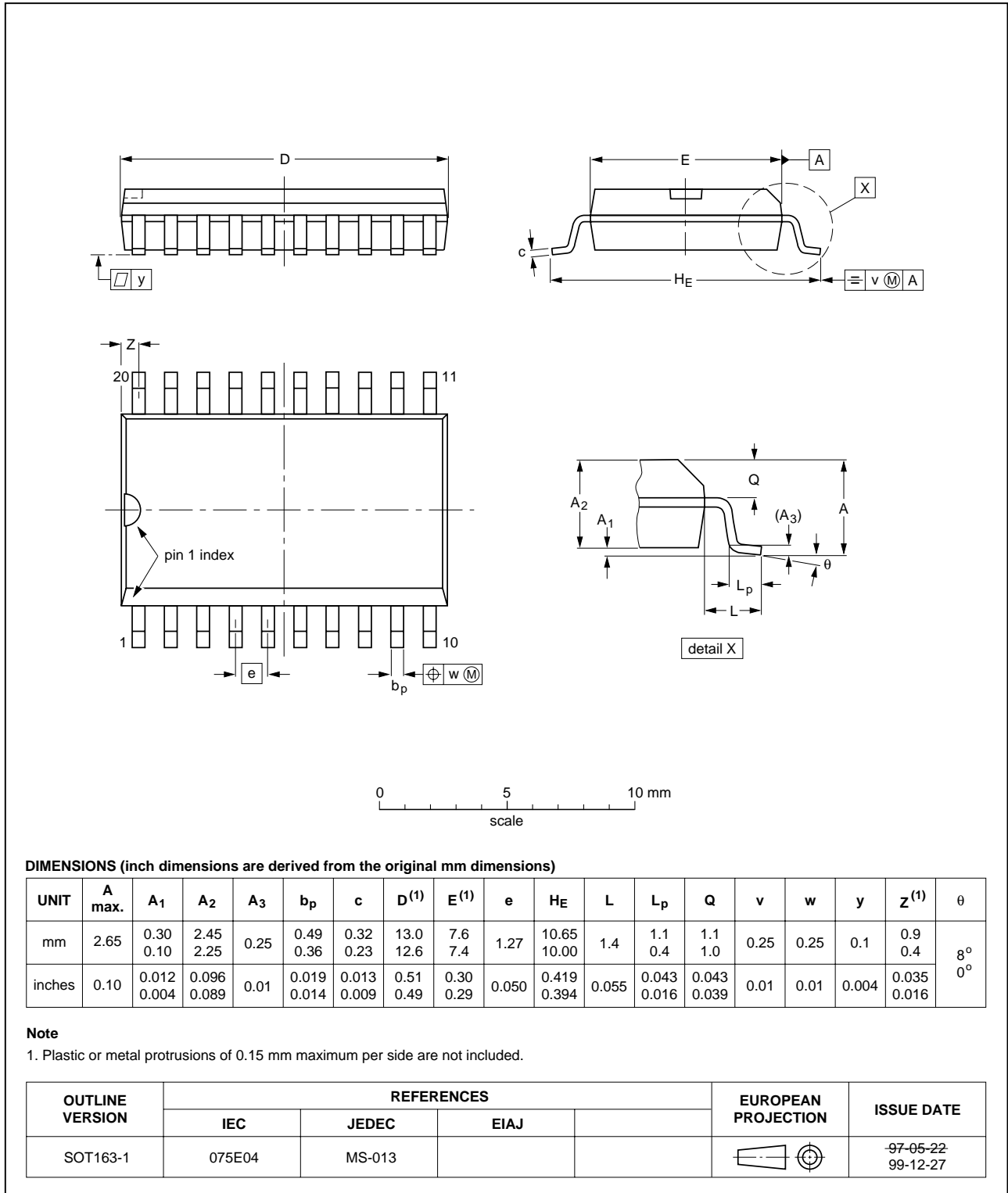


Fig 22.

## 9. Revision history

---

Table 7: Revision history

Rev	Date	CPCN	Description
01	20030331	-	Product data (9397 750 10955)

---

## 10. Data sheet status

Level	Data sheet status <sup>[1]</sup>	Product status <sup>[2][3]</sup>	Definition
I	Objective data	Development	This data sheet contains data from the objective specification for product development. Philips Semiconductors reserves the right to change the specification in any manner without notice.
II	Preliminary data	Qualification	This data sheet contains data from the preliminary specification. Supplementary data will be published at a later date. Philips Semiconductors reserves the right to change the specification without notice, in order to improve the design and supply the best possible product.
III	Product data	Production	This data sheet contains data from the product specification. Philips Semiconductors reserves the right to make changes at any time in order to improve the design, manufacturing and supply. Relevant changes will be communicated via a Customer Product/Process Change Notification (CPCN).

[1] Please consult the most recently issued data sheet before initiating or completing a design.

[2] The product status of the device(s) described in this data sheet may have changed since this data sheet was published. The latest information is available on the Internet at URL <http://www.semiconductors.philips.com>.

[3] For data sheets describing multiple type numbers, the highest-level product status determines the data sheet status.

## 11. Definitions

**Short-form specification** — The data in a short-form specification is extracted from a full data sheet with the same type number and title. For detailed information see the relevant data sheet or data handbook.

**Limiting values definition** — Limiting values given are in accordance with the Absolute Maximum Rating System (IEC 60134). Stress above one or more of the limiting values may cause permanent damage to the device. These are stress ratings only and operation of the device at these or at any other conditions above those given in the Characteristics sections of the specification is not implied. Exposure to limiting values for extended periods may affect device reliability.

**Application information** — Applications that are described herein for any of these products are for illustrative purposes only. Philips Semiconductors make no representation or warranty that such applications will be suitable for the specified use without further testing or modification.

## 12. Disclaimers

**Life support** — These products are not designed for use in life support appliances, devices, or systems where malfunction of these products can reasonably be expected to result in personal injury. Philips Semiconductors

customers using or selling these products for use in such applications do so at their own risk and agree to fully indemnify Philips Semiconductors for any damages resulting from such application.

**Right to make changes** — Philips Semiconductors reserves the right to make changes in the products - including circuits, standard cells, and/or software - described or contained herein in order to improve design and/or performance. When the product is in full production (status 'Production'), relevant changes will be communicated via a Customer Product/Process Change Notification (CPCN). Philips Semiconductors assumes no responsibility or liability for the use of any of these products, conveys no licence or title under any patent, copyright, or mask work right to these products, and makes no representations or warranties that these products are free from patent, copyright, or mask work right infringement, unless otherwise specified.

## 13. Trademarks

**TOPFET** — is a trademark of Koninklijke Philips Electronics N.V.

**TrenchMOS** — is a trademark of Koninklijke Philips Electronics N.V.

## Contact information

For additional information, please visit <http://www.semiconductors.philips.com>.

For sales office addresses, send e-mail to: [sales.addresses@www.semiconductors.philips.com](mailto:sales.addresses@www.semiconductors.philips.com).

Fax: +31 40 27 24825

## Contents

<b>1</b>	<b>Product profile</b> .....	<b>1</b>
1.1	Description .....	1
1.2	Features .....	1
1.3	Applications .....	1
1.4	Quick reference data .....	1
<b>2</b>	<b>Pinning information</b> .....	<b>2</b>
2.1	Pin description .....	2
<b>3</b>	<b>Block diagram</b> .....	<b>3</b>
<b>4</b>	<b>Limiting values</b> .....	<b>4</b>
<b>5</b>	<b>Thermal characteristics</b> .....	<b>5</b>
<b>6</b>	<b>Static characteristics</b> .....	<b>6</b>
<b>7</b>	<b>Dynamic characteristics</b> .....	<b>11</b>
<b>8</b>	<b>Package outline</b> .....	<b>12</b>
<b>9</b>	<b>Revision history</b> .....	<b>13</b>
<b>10</b>	<b>Data sheet status</b> .....	<b>14</b>
<b>11</b>	<b>Definitions</b> .....	<b>14</b>
<b>12</b>	<b>Disclaimers</b> .....	<b>14</b>
<b>13</b>	<b>Trademarks</b> .....	<b>14</b>



# PHILIPS

*Let's make things better.*