

FEATURES

- 3 dB bandwidth of 2.9 GHz ($A_v = 6$ dB)
- Low supply current: 40 mA
- Pin-strappable gain adjust: 6 dB, 12 dB, 15.5 dB
- Differential or single-ended input to differential output
- Low noise input stage: 2.1 nV/ $\sqrt{\text{Hz}}$ RTI at $A_v = 12$ dB
- Low broadband distortion ($A_v = 6$ dB)
 - 10 MHz: –94 dBc HD2, –87 dBc HD3
 - 70 MHz: –98 dBc HD2, –87 dBc HD3
 - 140 MHz: –95 dBc HD2, –87 dBc HD3
 - 250 MHz: –80 dBc HD2, –73 dBc HD3
- IMD3s of –86 dBc @ 250 MHz center
- Slew rate: 9.8 V/ns
- Fast settling of 2 ns and overdrive recovery of 3 ns
- Single-supply operation: 3 V to 3.6 V
- Power-down control
- Fabricated using the high speed XFCB3 SiGe process

APPLICATIONS

- Differential ADC drivers
- Single-ended-to-differential conversion
- RF/IF gain blocks
- SAW filter interfacing

GENERAL DESCRIPTION

The ADL5561 is a high performance differential amplifier optimized for RF and IF applications. The amplifier offers low noise of 2.1 nV/ $\sqrt{\text{Hz}}$ and excellent distortion performance over a wide frequency range, making it an ideal driver for high speed 8-bit to 16-bit analog-to-digital converters (ADCs).

The ADL5561 provides three gain levels of 6 dB, 12 dB, and 15.5 dB through a pin-strappable configuration. For the single-ended input configuration, the gains are reduced to 5.6 dB, 11.1 dB, and 14.1 dB. Using an external series input resistor expands the amplifier gain flexibility and allows for any gain selection from 0 dB to 15.5 dB.

The quiescent current of the ADL5561 is typically 40 mA and, when disabled, consumes less than 3 mA, offering excellent input-to-output isolation.

FUNCTIONAL BLOCK DIAGRAM

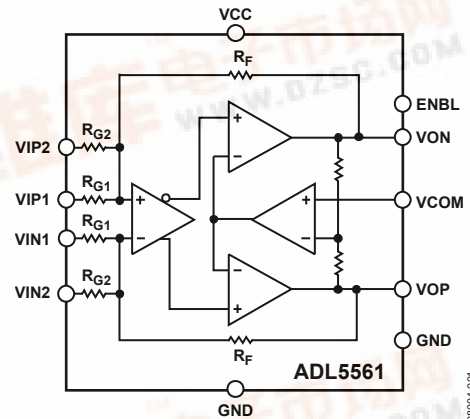

Figure 1.

The device is optimized for wideband, low distortion performance. These attributes, together with its adjustable gain capability, make this device the amplifier of choice for general-purpose IF and broadband applications where low distortion, noise, and power are critical. This device is optimized for the best combination of slew speed, bandwidth, and broadband distortion. These attributes allow it to drive a wide variety of ADCs and make it ideally suited for driving mixers, pin diode attenuators, SAW filters, and multi-element discrete devices.

Fabricated on the Analog Devices, Inc., high speed SiGe process, the ADL5561 is supplied in a compact 3 mm × 3 mm, 16-lead LFCSP package and operates over the temperature range of –40°C to +85°C.

Rev. B

Information furnished by Analog Devices is believed to be accurate and reliable. However, no responsibility is assumed by Analog Devices for its use, nor for any infringements of patents or other rights of third parties that may result from its use. Specifications subject to change without notice. No license is granted by implication or otherwise under any patent or patent rights of Analog Devices. Trademarks and registered trademarks are the property of their respective owners.



TABLE OF CONTENTS

Features	1	Applications Information	14
Applications.....	1	Basic Connections.....	14
Functional Block Diagram	1	Input and Output Interfacing	15
General Description	1	Gain Adjustment and Interfacing	16
Revision History	2	ADC Interfacing.....	16
Specifications.....	3	Layout Considerations.....	18
Absolute Maximum Ratings.....	6	Soldering Information	19
ESD Caution.....	6	Evaluation Board	19
Pin Configuration and Function Descriptions.....	7	Outline Dimensions	21
Typical Performance Characteristics	8	Ordering Guide	21
Circuit Description.....	13		
Basic Structure	13		

REVISION HISTORY

3/10—Rev A to Rev. B

Changes to Figure 43.....	21
Changes to Ordering Guide	21

9/09—Rev 0 to Rev. A

Changes to Features Section.....	1
Changes to Table 1.....	3
Changes to Figure 5.....	8
Changes to Figure 9 and Figure 10.....	9
Changes to Equation 1, Figure 32, and Figure 34.....	15
Changes to Equation 2	16
Changes to Figure 38, Figure 39, Figure 40, and Table 9.....	17
Changes to Figure 43.....	19
Moved Table 14 to	19

5/09—Revision 0: Initial Version

SPECIFICATIONS

VCC = 3.3 V, VCOM = 1.65 V, RL = 200 Ω differential, AV = 6 dB, CL = 1 pF differential, f = 140 MHz, TA = 25°C.

Table 1.

Parameter	Conditions	Min	Typ	Max	Unit
DYNAMIC PERFORMANCE					
-3 dB Bandwidth	AV = 6 dB, VOUT ≤ 1.0 V p-p		2900		MHz
	AV = 12 dB, VOUT ≤ 1.0 V p-p		2300		MHz
	AV = 15.5 dB, VOUT ≤ 1.0 V p-p		1800		MHz
Bandwidth for 0.1 dB Flatness	AV = 6 dB, VOUT ≤ 1.0 V p-p		200		MHz
	AV = 12 dB, VOUT ≤ 1.0 V p-p		200		MHz
	AV = 15.5 dB, VOUT ≤ 1.0 V p-p		600		MHz
Gain Accuracy	AV = 6 dB, RL = open		0.15		dB
	AV = 12 dB, RL = open		0.05		dB
	AV = 15.5 dB, RL = open		0.05		dB
Gain Supply Sensitivity	VCC ± 10%		-0.023		dB/V
Gain Temperature Sensitivity	-40°C to +85°C, AV = 15.5 dB		0.24		mdB/°C
Slew Rate	Rise, AV = 15.5 dB, RL = 200 Ω, VOUT = 2 V step		9.8		V/ns
	Fall, AV = 15.5 dB, RL = 200 Ω, VOUT = 2 V step		10.1		V/ns
Settling Time	2 V step to 1%		2		ns
Overdrive Recovery Time	VIN = 4 V to 0 V step, VOUT ≤ ±10 mV		3		ns
Reverse Isolation (S12)			60		dB
INPUT/OUTPUT CHARACTERISTICS					
Output Common Mode			VCC/2		V
Voltage Adjustment Range			1.4 to 1.8		V
Maximum Output Voltage Swing	1 dB compressed		4.3		V p-p
Output Common-Mode Offset	Referenced to VCC/2		25		mV
Output Common-Mode Drift	-40°C to +85°C		170		μV/°C
Output Differential Offset Voltage			1		mV
CMRR			65		dB
Output Differential Offset Drift	-40°C to +85°C		15		μV/°C
Input Bias Current			3		μA
Input Resistance (Differential)	AV = 6 dB		400		Ω
	AV = 12 dB		200		Ω
	AV = 15.5 dB		133		Ω
Input Resistance (Single-Ended) ¹	AV = 5.6 dB, RS = 50 Ω		307		Ω
	AV = 11.1 dB, RS = 50 Ω		179		Ω
	AV = 14.1 dB, RS = 50 Ω		132		Ω
Input Capacitance (Single-Ended)			0.3		pF
Output Resistance (Differential)			12		Ω
POWER INTERFACE					
Supply Voltage		3	3.3	3.6	V
ENBL Threshold	Device disabled, ENBL low		0.6		V
	Device enabled, ENBL high		1.3		V
ENBL Input Bias Current	ENBL high		-27		μA
	ENBL low		-300		μA
Quiescent Current	ENBL high	37	40	44.5	mA
	ENBL low		3		mA

ADL5561

[查询"ADL5561"供应商](#)

Parameter	Conditions	Min	Typ	Max	Unit
10 MHz NOISE/HARMONIC PERFORMANCE					
Second/Third Harmonic Distortion	$A_V = 6 \text{ dB}, R_L = 200 \Omega, V_{OUT} = 2 \text{ V p-p}$		-94/-87		dBc
	$A_V = 12 \text{ dB}, R_L = 200 \Omega, V_{OUT} = 2 \text{ V p-p}$		-92/-88		dBc
	$A_V = 15.5 \text{ dB}, R_L = 200 \Omega, V_{OUT} = 2 \text{ V p-p}$		-95/-87		dBc
Output Third-Order Intercept/Third-Order Intermodulation Distortion	$A_V = 6 \text{ dB}, R_L = 200 \Omega, V_{OUT} = 2 \text{ V p-p}$ composite (2 MHz spacing)		+42.7/-89		dBm/dBc
	$A_V = 12 \text{ dB}, R_L = 200 \Omega, V_{OUT} = 2 \text{ V p-p}$ composite (2 MHz spacing)		+41/-85		dBm/dBc
	$A_V = 15.5 \text{ dB}, R_L = 200 \Omega, V_{OUT} = 2 \text{ V p-p}$ composite (2 MHz spacing)		+40/-85		dBm/dBc
Noise Spectral Density (RTI)	$A_V = 6 \text{ dB}$		3		nV/ $\sqrt{\text{Hz}}$
	$A_V = 12 \text{ dB}$		2.1		nV/ $\sqrt{\text{Hz}}$
	$A_V = 15.5 \text{ dB}$		1.7		nV/ $\sqrt{\text{Hz}}$
1 dB Compression Point (RTO)	$A_V = 6 \text{ dB}$		19		dBm
	$A_V = 12 \text{ dB}$		19		dBm
	$A_V = 15.5 \text{ dB}$		19		dBm
70 MHz NOISE/HARMONIC PERFORMANCE					
Second/Third Harmonic Distortion	$A_V = 6 \text{ dB}, R_L = 200 \Omega, V_{OUT} = 2 \text{ V p-p}$		-98/-87		dBc
	$A_V = 12 \text{ dB}, R_L = 200 \Omega, V_{OUT} = 2 \text{ V p-p}$		-93/-83		dBc
	$A_V = 15.5 \text{ dB}, R_L = 200 \Omega, V_{OUT} = 2 \text{ V p-p}$		-93/-82		dBc
Output Third-Order Intercept/Third-Order Intermodulation Distortion	$A_V = 6 \text{ dB}, R_L = 200 \Omega, V_{OUT} = 2 \text{ V p-p}$ composite (2 MHz spacing)		+45/-93		dBm/dBc
	$A_V = 12 \text{ dB}, R_L = 200 \Omega, V_{OUT} = 2 \text{ V p-p}$ composite (2 MHz spacing)		+43/-89		dBm/dBc
	$A_V = 15.5 \text{ dB}, R_L = 200 \Omega, V_{OUT} = 2 \text{ V p-p}$ composite (2 MHz spacing)		+41/-86		dBm/dBc
Noise Spectral Density (RTI)	$A_V = 6 \text{ dB}$		3		nV/ $\sqrt{\text{Hz}}$
	$A_V = 12 \text{ dB}$		2.1		nV/ $\sqrt{\text{Hz}}$
	$A_V = 15.5 \text{ dB}$		1.7		nV/ $\sqrt{\text{Hz}}$
1 dB Compression Point (RTO)	$A_V = 6 \text{ dB}$		19		dBm
	$A_V = 12 \text{ dB}$		18.9		dBm
	$A_V = 15.5 \text{ dB}$		18.9		dBm
140 MHz NOISE/HARMONIC PERFORMANCE					
Second/Third Harmonic Distortion	$A_V = 6 \text{ dB}, R_L = 200 \Omega, V_{OUT} = 2 \text{ V p-p}$		-95/-87		dBc
	$A_V = 12 \text{ dB}, R_L = 200 \Omega, V_{OUT} = 2 \text{ V p-p}$		-83/-83		dBc
	$A_V = 15.5 \text{ dB}, R_L = 200 \Omega, V_{OUT} = 2 \text{ V p-p}$		-83/-82		dBc
Output Third-Order Intercept/Third-Order Intermodulation Distortion	$A_V = 6 \text{ dB}, R_L = 200 \Omega, V_{OUT} = 2 \text{ V p-p}$ composite (2 MHz spacing)		+49/-102		dBm/dBc
	$A_V = 12 \text{ dB}, R_L = 200 \Omega, V_{OUT} = 2 \text{ V p-p}$ composite (2 MHz spacing)		+48/-100		dBm/dBc
	$A_V = 15.5 \text{ dB}, R_L = 200 \Omega, V_{OUT} = 2 \text{ V p-p}$ composite (2 MHz spacing)		+39/-96		dBm/dBc
Noise Spectral Density (RTI)	$A_V = 6 \text{ dB}$		3		nV/ $\sqrt{\text{Hz}}$
	$A_V = 12 \text{ dB}$		2.1		nV/ $\sqrt{\text{Hz}}$
	$A_V = 15.5 \text{ dB}$		1.7		nV/ $\sqrt{\text{Hz}}$
1 dB Compression Point (RTO)	$A_V = 6 \text{ dB}$		19.1		dBm
	$A_V = 12 \text{ dB}$		18.8		dBm
	$A_V = 15.5 \text{ dB}$		18.7		dBm

Parameter	Conditions	Min	Typ	Max	Unit
250 MHz NOISE/HARMONIC PERFORMANCE					
Second/Third Harmonic Distortion	$A_V = 6 \text{ dB}$, $R_L = 200 \Omega$, $V_{OUT} = 2 \text{ V p-p}$		-80/-73		dBc
	$A_V = 12 \text{ dB}$, $R_L = 200 \Omega$, $V_{OUT} = 2 \text{ V p-p}$		-76/-70		dBc
	$A_V = 15.5 \text{ dB}$, $R_L = 200 \Omega$, $V_{OUT} = 2 \text{ V p-p}$		-78/-72		dBc
Output Third-Order Intercept/Third-Order Intermodulation Distortion	$A_V = 6 \text{ dB}$, $R_L = 200 \Omega$, $V_{OUT} = 2 \text{ V p-p}$ composite (2 MHz spacing)		+41/-86		dBm/dBc
	$A_V = 12 \text{ dB}$, $R_L = 200 \Omega$, $V_{OUT} = 2 \text{ V p-p}$ composite (2 MHz spacing)		+40/-84		dBm/dBc
	$A_V = 15.5 \text{ dB}$, $R_L = 200 \Omega$, $V_{OUT} = 2 \text{ V p-p}$ composite (2 MHz spacing)		+39/-83		dBm/dBc
Noise Spectral Density (RTI)	$A_V = 6 \text{ dB}$		3.2		nV/ $\sqrt{\text{Hz}}$
	$A_V = 12 \text{ dB}$		2.2		nV/ $\sqrt{\text{Hz}}$
	$A_V = 15.5 \text{ dB}$		1.7		nV/ $\sqrt{\text{Hz}}$
1 dB Compression Point (RTO)	$A_V = 6 \text{ dB}$		19.1		dBm
	$A_V = 12 \text{ dB}$		18.9		dBm
	$A_V = 15.5 \text{ dB}$		18.7		dBm
500 MHz NOISE/HARMONIC PERFORMANCE					
Second/Third Harmonic Distortion	$A_V = 6 \text{ dB}$, $R_L = 200 \Omega$, $V_{OUT} = 1 \text{ V p-p}$		-69/-57		dBc
	$A_V = 12 \text{ dB}$, $R_L = 200 \Omega$, $V_{OUT} = 1 \text{ V p-p}$		-72/-60		dBc
	$A_V = 15.5 \text{ dB}$, $R_L = 200 \Omega$, $V_{OUT} = 1 \text{ V p-p}$		-66/-61		dBc
Output Third-Order Intercept/Third-Order Intermodulation Distortion	$A_V = 6 \text{ dB}$, $R_L = 200 \Omega$, $V_{OUT} = 1 \text{ V p-p}$ composite (2 MHz spacing)		+40/-97		dBm/dBc
	$A_V = 12 \text{ dB}$, $R_L = 200 \Omega$, $V_{OUT} = 1 \text{ V p-p}$ composite (2 MHz spacing)		+36/-90		dBm/dBc
	$A_V = 15.5 \text{ dB}$, $R_L = 200 \Omega$, $V_{OUT} = 1 \text{ V p-p}$ composite (2 MHz spacing)		+34/-75		dBm/dBc
Noise Spectral Density (RTI)	$A_V = 6 \text{ dB}$		4.1		nV/ $\sqrt{\text{Hz}}$
	$A_V = 12 \text{ dB}$		2.4		nV/ $\sqrt{\text{Hz}}$
	$A_V = 15.5 \text{ dB}$		1.8		nV/ $\sqrt{\text{Hz}}$
1 dB Compression Point (RTO)	$A_V = 6 \text{ dB}$		16.3		dBm
	$A_V = 12 \text{ dB}$		16.4		dBm
	$A_V = 15.5 \text{ dB}$		16.2		dBm
1000 MHz NOISE/HARMONIC PERFORMANCE					
Second/Third Harmonic Distortion	$A_V = 6 \text{ dB}$, $R_L = 200 \Omega$, $V_{OUT} = 1 \text{ V p-p}$		-58/-53		dBc
	$A_V = 12 \text{ dB}$, $R_L = 200 \Omega$, $V_{OUT} = 1 \text{ V p-p}$		-55/-50		dBc
	$A_V = 15.5 \text{ dB}$, $R_L = 200 \Omega$, $V_{OUT} = 1 \text{ V p-p}$		-57/-50		dBc
Output Third-Order Intercept/Third-Order Intermodulation Distortion	$A_V = 6 \text{ dB}$, $R_L = 200 \Omega$, $V_{OUT} = 1 \text{ V p-p}$ composite (2 MHz spacing)		+18/-54		dBm/dBc
	$A_V = 12 \text{ dB}$, $R_L = 200 \Omega$, $V_{OUT} = 1 \text{ V p-p}$ composite (2 MHz spacing)		+18/-56		dBm/dBc
	$A_V = 15.5 \text{ dB}$, $R_L = 200 \Omega$, $V_{OUT} = 1 \text{ V p-p}$ composite (2 MHz spacing)		+18/-46		dBm/dBc
Noise Spectral Density (RTI)	$A_V = 6 \text{ dB}$		6		nV/ $\sqrt{\text{Hz}}$
	$A_V = 12 \text{ dB}$		2.6		nV/ $\sqrt{\text{Hz}}$
	$A_V = 15.5 \text{ dB}$		1.8		nV/ $\sqrt{\text{Hz}}$
1 dB Compression Point (RTO)	$A_V = 6 \text{ dB}$		10.8		dBm
	$A_V = 12 \text{ dB}$		12.6		dBm
	$A_V = 15.5 \text{ dB}$		12.5		dBm

¹ See the Applications Information section for a discussion of single-ended input, dc-coupled operation.

ABSOLUTE MAXIMUM RATINGS

Table 2.

Parameter	Rating
Supply Voltage (VCC)	3.6 V
VIP1, VIP2, VIN1, VIN2	VCC + 0.5 V
Internal Power Dissipation	155 mW
θ_{JA}	98.3°C/W
Maximum Junction Temperature	125°C
Operating Temperature Range	-40°C to +85°C
Storage Temperature Range	-65°C to +150°C

Stresses above those listed under Absolute Maximum Ratings may cause permanent damage to the device. This is a stress rating only; functional operation of the device at these or any other conditions above those indicated in the operational section of this specification is not implied. Exposure to absolute maximum rating conditions for extended periods may affect device reliability.

ESD CAUTION



ESD (electrostatic discharge) sensitive device. Charged devices and circuit boards can discharge without detection. Although this product features patented or proprietary protection circuitry, damage may occur on devices subjected to high energy ESD. Therefore, proper ESD precautions should be taken to avoid performance degradation or loss of functionality.

PIN CONFIGURATION AND FUNCTION DESCRIPTIONS

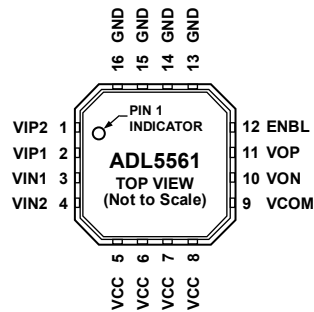

NOTES
 1. EXPOSED PADDLE. CONNECT TO A LOW IMPEDANCE THERMAL AND ELECTRICAL GROUND PLANE.

08004-031

Figure 2. Pin Configuration

Table 3. Pin Function Descriptions

Pin No.	Mnemonic	Description
1	VIP2	Balanced Differential Input. Biased to VCOM, typically ac-coupled. Input for $A_v = 12$ dB gain, strapped to VIP1 for $A_v = 15.5$ dB.
2	VIP1	Balanced Differential Input. Biased to VCOM, typically ac-coupled. Input for $A_v = 6$ dB gain, strapped to VIP2 for $A_v = 15.5$ dB.
3	VIN1	Balanced Differential Input. Biased to VCOM, typically ac-coupled. Input for $A_v = 6$ dB gain, strapped to VIN2 for $A_v = 15.5$ dB.
4	VIN2	Balanced Differential Input. Biased to VCOM, typically ac-coupled. Input for $A_v = 12$ dB gain, strapped to VIN1 for $A_v = 15.5$ dB.
5, 6, 7, 8	VCC	Positive Supply.
9	VCOM	Common-Mode Voltage. A voltage applied to this pin sets the common-mode voltage of the input and output. Typically decoupled to ground with a $0.1 \mu\text{F}$ capacitor. With no reference applied, input and output common mode floats to midsupply ($VCC/2$).
10	VON	Balanced Differential Output. Biased to VCOM, typically ac-coupled.
11	VOP	Balanced Differential Output. Biased to VCOM, typically ac-coupled.
12	ENBL	Enable. Apply positive voltage ($1.0\text{ V} < \text{ENBL} < VCC$) to activate device.
13, 14, 15, 16	GND	Ground. Connect to low impedance ground.
	EP	Exposed Paddle. Connect to a low impedance thermal and electrical ground plane.

TYPICAL PERFORMANCE CHARACTERISTICS

VCC = 3.3 V, VCOM = 1.65 V, RL = 200 Ω differential, Av = 6 dB, CL = 1 pF differential, f = 140 MHz, and TA = 25°C.

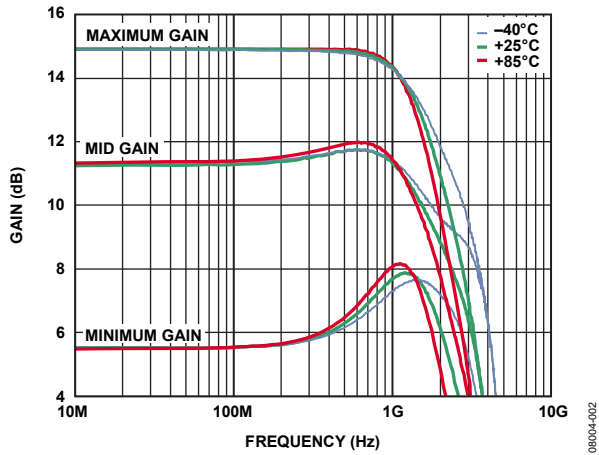

Figure 3. Gain vs. Frequency Response for 200 Ω Differential Load, Av = 6 dB, Av = 12 dB, and Av = 15.5 dB over Temperature

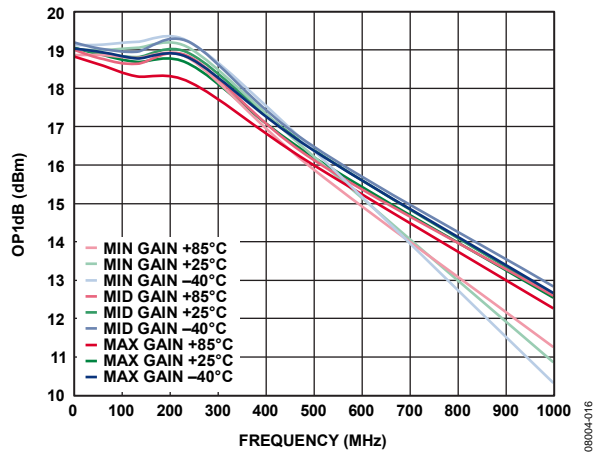

Figure 6. Output P1dB (OP1dB) vs. Frequency at Av = 6 dB, Av = 12 dB, and Av = 15.5 dB over Temperature, 200 Ω Differential Load

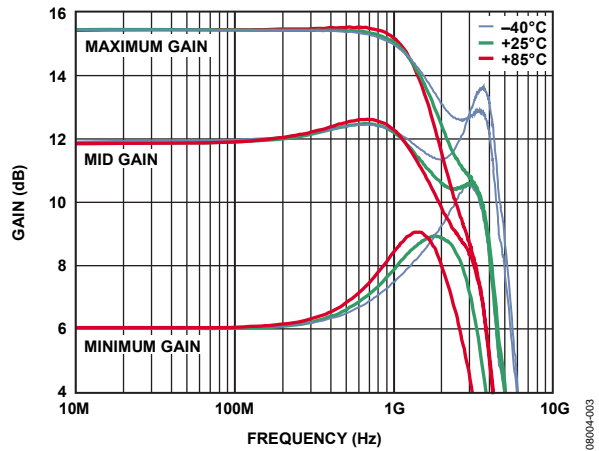

Figure 4. Gain vs. Frequency Response for 1 kΩ Differential Load, Av = 6 dB, Av = 12 dB, and Av = 15.5 dB over Temperature

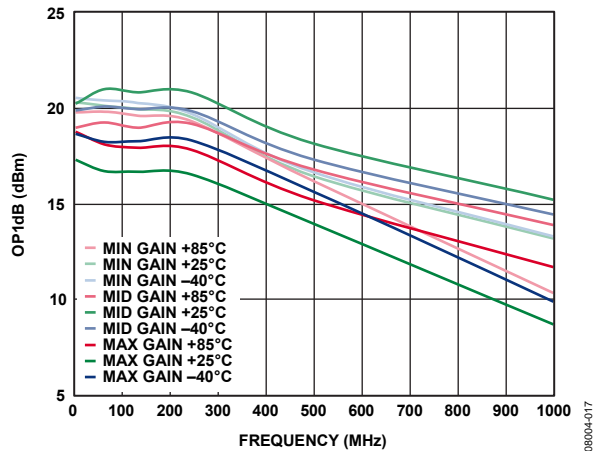

Figure 7. Output P1dB (OP1dB) vs. Frequency at Av = 6 dB, Av = 12 dB, and Av = 15.5 dB over Temperature, 1 kΩ Differential Load

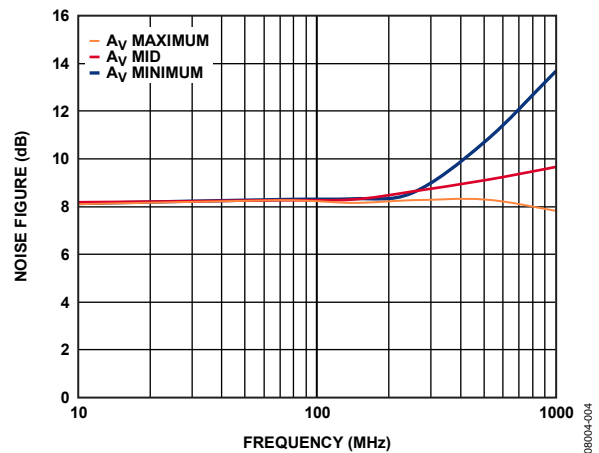

Figure 5. Noise Figure vs. Frequency at Av = 6 dB, Av = 12 dB, and Av = 15.5 dB

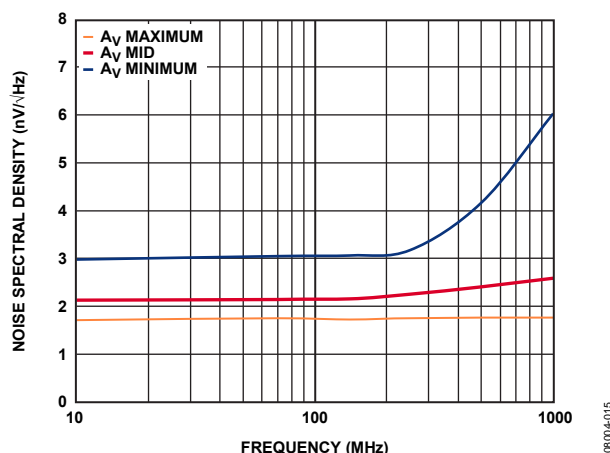

Figure 8. Noise Spectral Density vs. Frequency at Av = 6 dB, Av = 12 dB, and Av = 15.5 dB

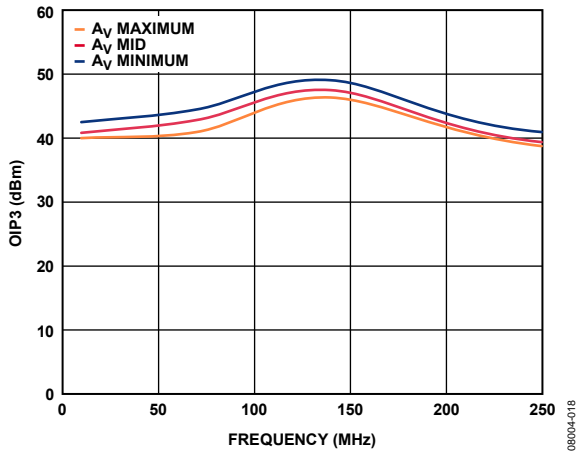

Figure 9. Output Third-Order Intercept at Three Gains, Output Level at 2 V p-p Composite, $R_L = 200 \Omega$

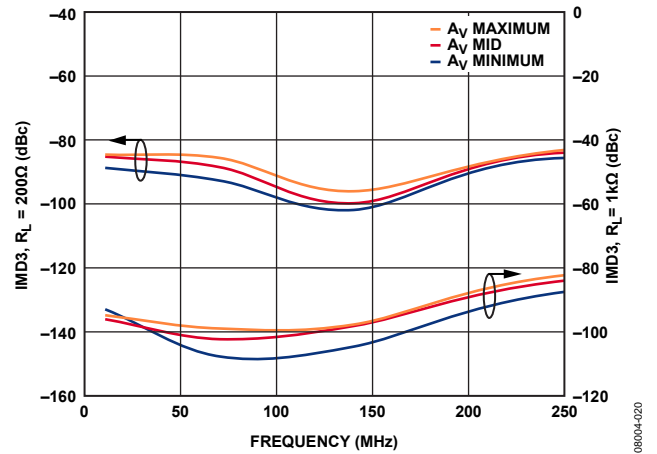

Figure 12. Two-Tone Output IMD vs. Frequency, Output Level at 2 V p-p Composite, $R_L = 200 \Omega$ and $R_L = 1 k\Omega$

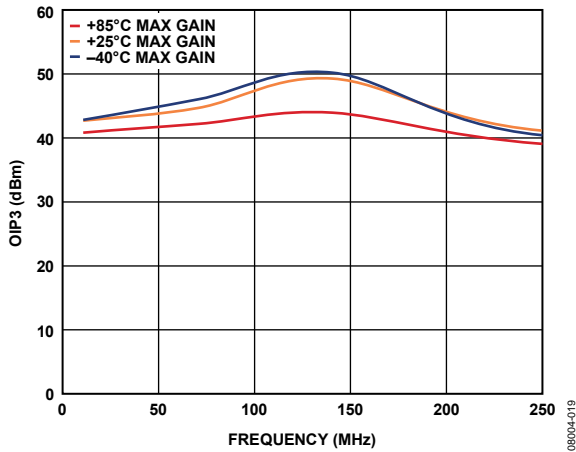

Figure 10. Output Third-Order Intercept vs. Frequency, Over Temperature, Output Level at 2 V p-p Composite, $R_L = 200 \Omega$

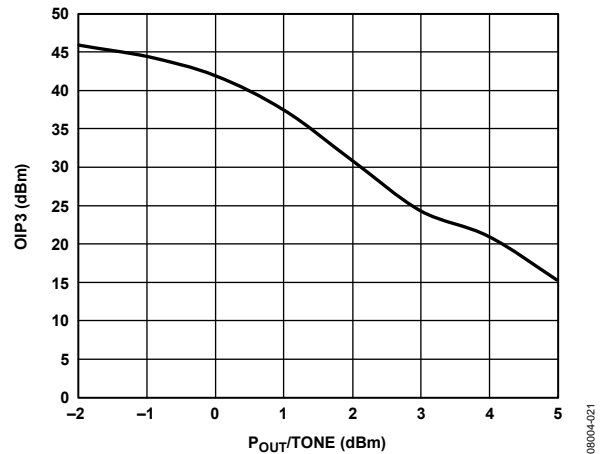

Figure 13. Output Third-Order Intercept (OIP3) vs. Power (P_{OUT}), Frequency 140 MHz, $A_V = 15.5 \text{ dB}$

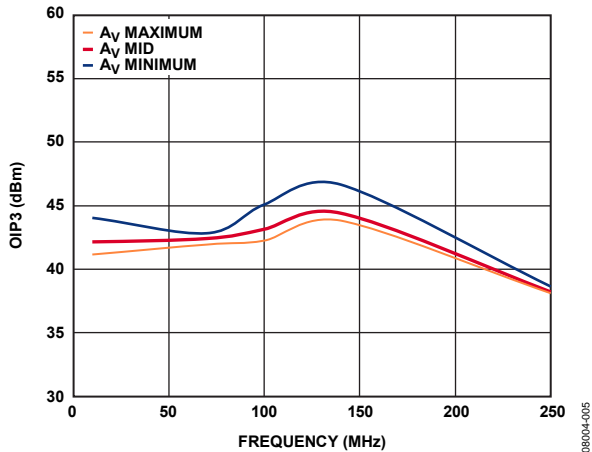

Figure 11. OIP3 vs. Frequency (Single-Ended Input)

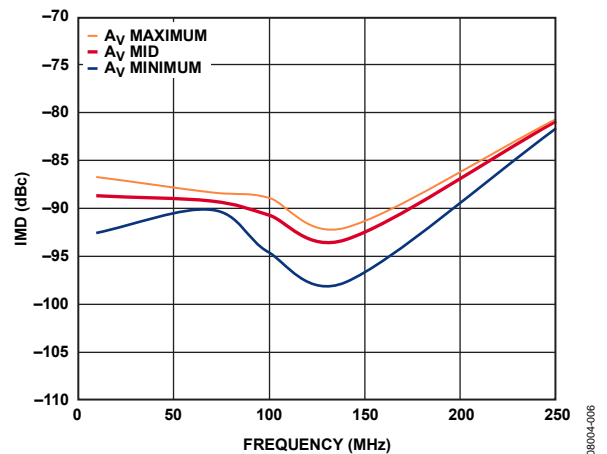

Figure 14. IMD vs. Frequency (Single-Ended Input)

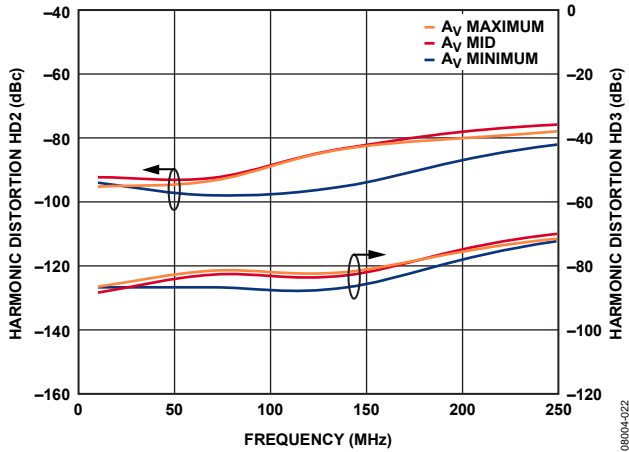

Figure 15. Harmonic Distortion (HD2/HD3) vs. Frequency at $A_v = 6$ dB, $A_v = 12$ dB, and $A_v = 15.5$ dB, Output Level at 2 V p-p, $R_L = 200 \Omega$

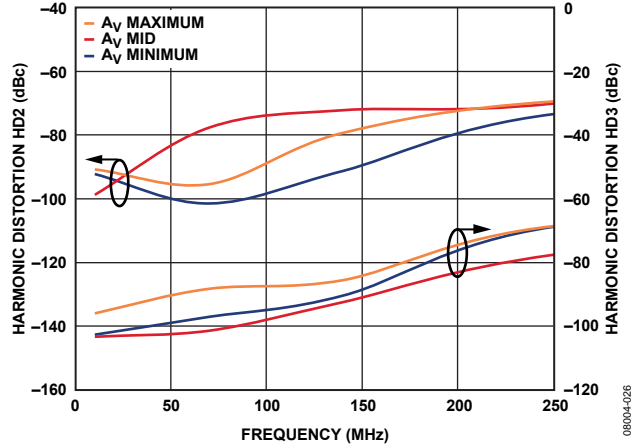

Figure 18. Harmonic Distortion (HD2/HD3) vs. Frequency at $A_v = 6$ dB, $A_v = 12$ dB, and $A_v = 15.5$ dB, Output Level at 2 V p-p, $R_L = 1 k\Omega$

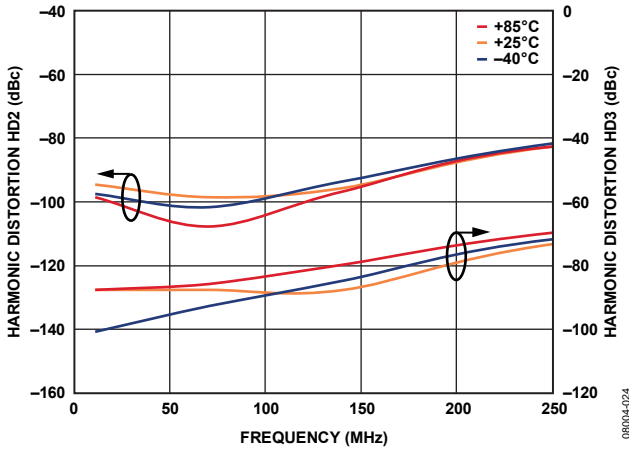

Figure 16. Harmonic Distortion (HD2/HD3) vs. Frequency, Three Temperatures, Output Level at 2 V p-p, $R_L = 200 \Omega$

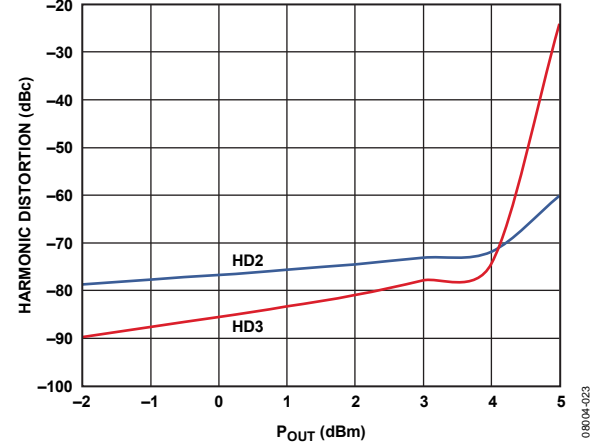

Figure 19. Harmonic Distortion (HD2/HD3) vs. Power, Frequency 140 MHz, $A_v = 15.5$ dB

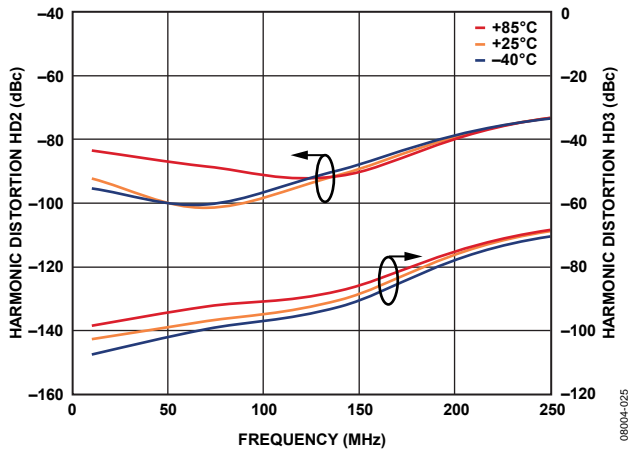

Figure 17. Harmonic Distortion (HD2/HD3) vs. Frequency, Over Temperature, Output Level at 2 V p-p, $R_L = 1 k\Omega$

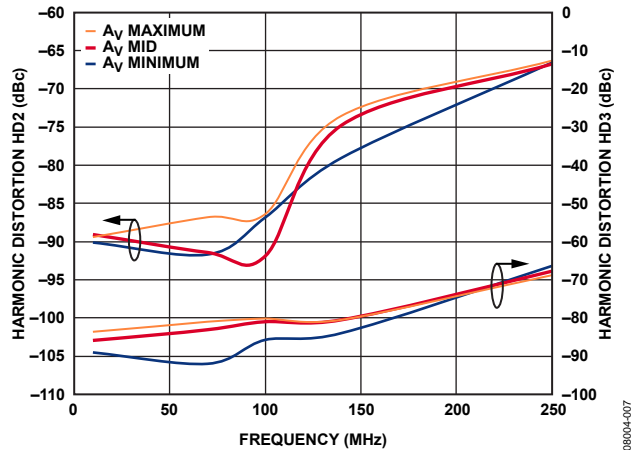

Figure 20. Harmonic Distortion (HD2/HD3) vs. Frequency (Single-Ended Input)

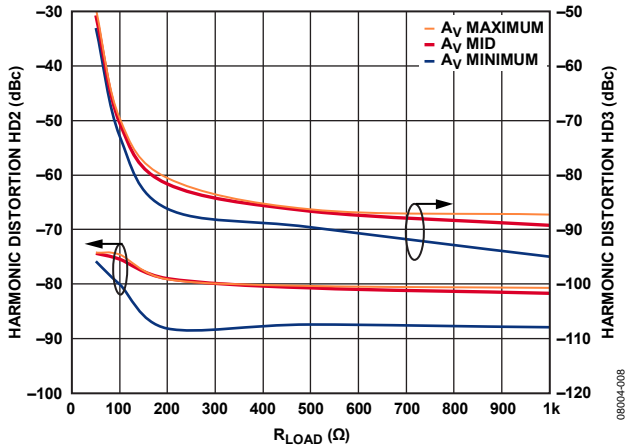

Figure 21. Harmonic Distortion (HD2/HD3) vs. R_{LOAD}

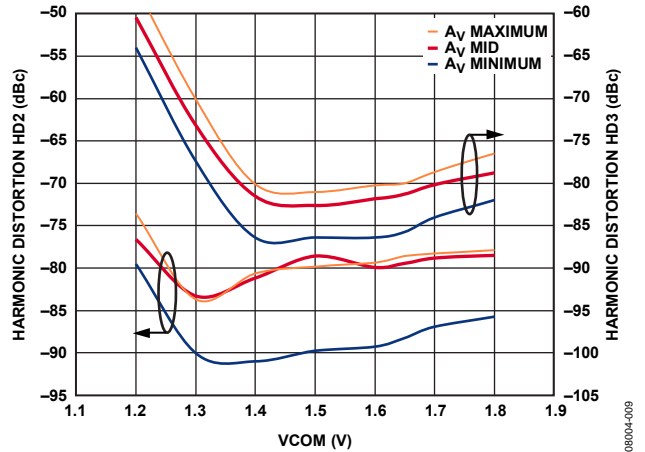

Figure 24. Harmonic Distortion (HD2/HD3) vs. V_{COM}

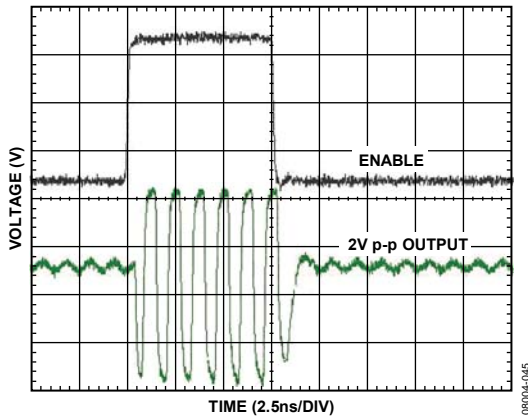

Figure 22. ENBL Time Domain Response

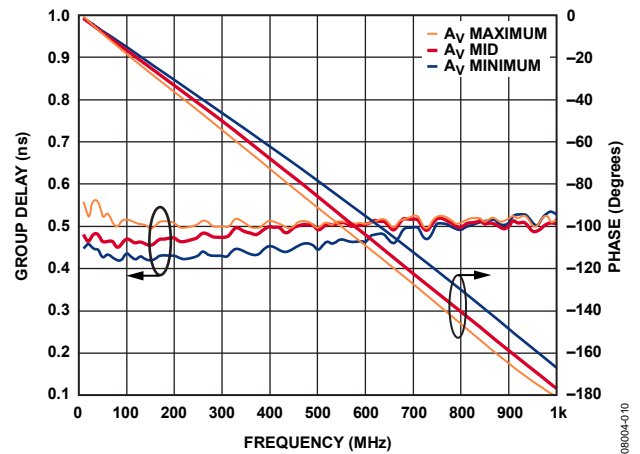

Figure 25. Group Delay and Phase vs. Frequency

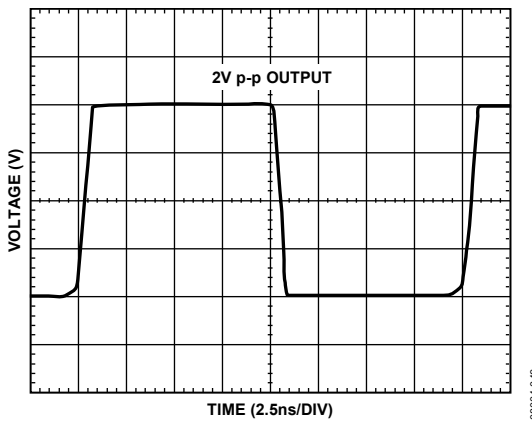

Figure 23. Large Signal Pulse Response, $A_V = 15.5$ dB

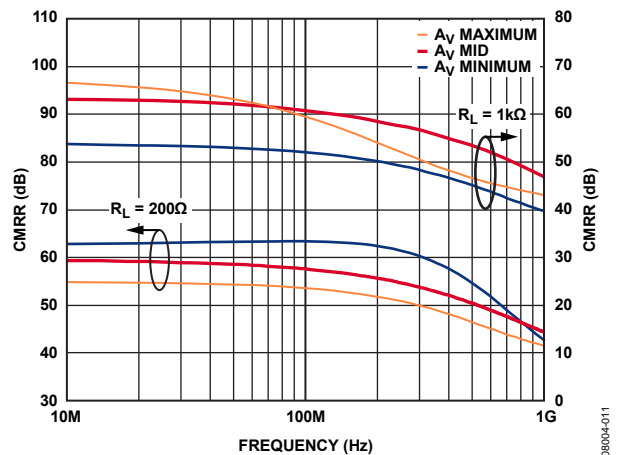

Figure 26. Common-Mode Rejection Ratio (CMRR) vs. Frequency

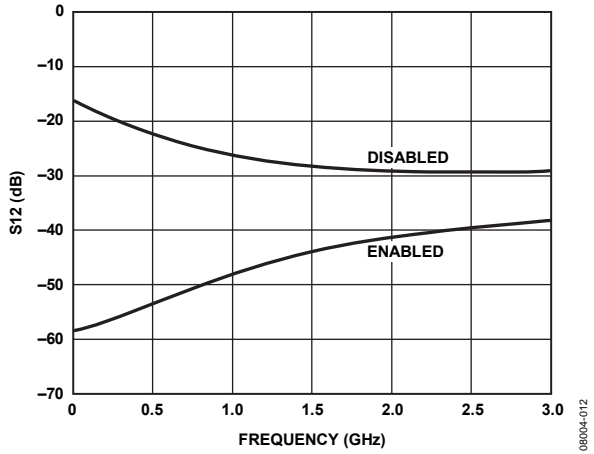

Figure 27. Reverse Isolation (S_{12}) vs. Frequency

08004-012

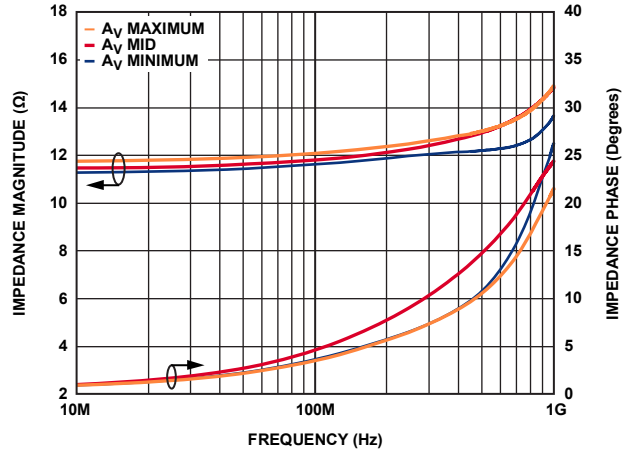

Figure 29. Output Impedance vs. Frequency

08004-014

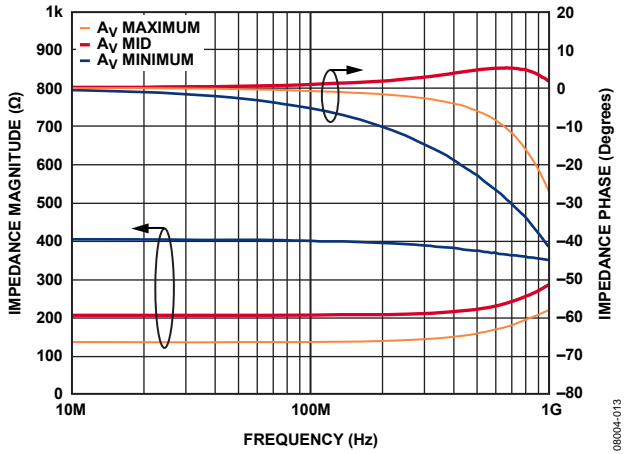

Figure 28. Input Impedance vs. Frequency

08004-013

CIRCUIT DESCRIPTION

BASIC STRUCTURE

The ADL5561 is a low noise, low power, fully differential amplifier/ADC driver that uses a 3.3 V supply. It provides three gain options (6 dB, 12 dB, and 15.5 dB) without the need for external resistors and has wide bandwidths of 2.6 GHz for 6 dB, 2.3 GHz for 12 dB, and 2.1 GHz for 15.5 dB. Differential input impedance is 400 Ω for 6 dB, 200 Ω for 12 dB, and 133 Ω for 15.5 dB. It has a differential output impedance of 10 Ω and an output common-mode adjust voltage of 1.25 V to 1.85 V.

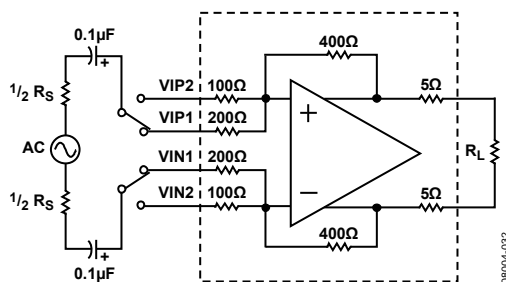

Figure 30. Basic Structure

The ADL5561 is composed of a fully differential amplifier with on-chip feedback and feed-forward resistors. The two feed-forward resistors on each input set this pin-strappable amplifier in three different gain configurations of 6 dB, 12 dB, and 15.5 dB.

The amplifier is designed to provide high differential open-loop gain and an output common-mode circuit that enables the user to change the common-mode voltage from a VCOM pin. The amplifier is designed to provide superior low distortion at frequencies up to and beyond 300 MHz with low noise and low power consumption. The low distortion and noise are realized with a 3.3 V power supply at 40 mA.

The ADL5561 is very flexible in terms of I/O coupling. It can be ac-coupled or dc-coupled at the inputs and/or the outputs within the specified input and output common-mode levels. The input of the device can be configured as single-ended or differential with similar distortion performance. Due to the internal connections between the inputs and outputs, keep the output common-mode voltage between 1.25 V and 1.85 V for the best distortion.

For a dc-coupled input, the input common mode should be between 1 V and 2.3 V for the best distortion. The device has been characterized using 2 V p-p into 200 Ω . If the inputs are ac-coupled, the input and output common-mode voltages are set by $V_{CC}/2$ when no external circuitry is used. The ADL5561 provides an output common-mode voltage set by VCOM, which allows driving an ADC directly without external components, such as a transformer or ac-coupling capacitors, provided that the VCOM of the amplifier is within the VCOM of the ADC. For dc-coupled requirements, the input VCM must be set by the VCOM pin in all three gain settings.

APPLICATIONS INFORMATION

BASIC CONNECTIONS

Figure 31 shows the basic connections for operating the ADL5561. VCC should be 3.3 V with each supply pin decoupled with at least one low inductance surface-mount ceramic capacitor of 0.1 μF placed as close as possible to the device. The VCOM pin (Pin 9) should also be decoupled using a 0.1 μF capacitor.

The gain of the part is determined by the pin-strappable input configuration. When Input A is applied to VIP1 and Input B is applied to VIN1, the gain is 6 dB (minimum gain; see Equation 1 and Equation 2). When Input A is applied to VIP2 and Input B is applied to VIN2, the gain is 12 dB (middle gain). When Input A is applied to VIP1 and VIP2 and Input B is applied to VIN1 and VIN2, the gain is 15.5 dB (maximum gain).

Pin 1 to Pin 4, Pin 10, and Pin 11 are biased at $1/2$ VCC above ground and can be dc-coupled (if within the specified input and output common-mode voltages levels) or ac-coupled, as shown in Figure 31.

To enable the ADL5561, the ENBL pin must be pulled high. Pulling the ENBL pin low puts the ADL5561 in sleep mode, reducing the current consumption to 3 mA at ambient.

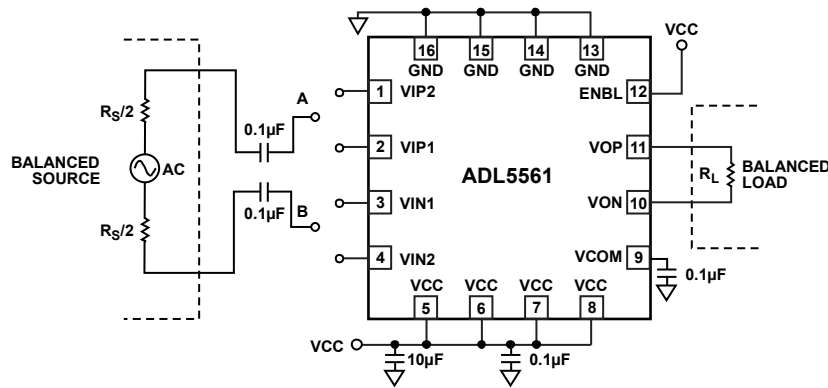
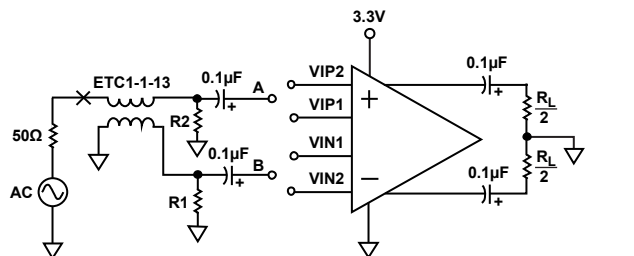

Figure 31. Basic Connections

018004-033

INPUT AND OUTPUT INTERFACING

The ADL5561 can be configured as a differential input to differential output driver, as shown in Figure 32. The differential broadband input is provided by the ETC1-1-13 balun transformer, and the two 34.8 Ω resistors provide a 50 Ω input match for the three input impedances that change with the variable gain strapping. The input and output 0.1 μF capacitors isolate the VCC/2 bias from the source and balanced load. The load must be 200 Ω to provide the expected ac performance (see the Specifications section and the Typical Performance Characteristics section).



- NOTES
1. FOR 6dB GAIN ($A_V = 2$), CONNECT INPUT A TO VIP1 AND INPUT B TO VIN1.
 2. FOR 12dB GAIN ($A_V = 4$), CONNECT INPUT A TO VIP2 AND INPUT B TO VIN2.
 3. FOR 15.5dB GAIN ($A_V = 6$), CONNECT INPUT A TO BOTH VIP1 AND VIP2 AND INPUT B TO BOTH VIN1 AND VIN2.

Figure 32. Differential-Input-to-Differential-Output Configuration

Table 4. Differential Termination Values for Figure 32

Gain (dB)	R1 (Ω)	R2 (Ω)
6	28.7	28.7
12	33.2	33.2
15.5	40.2	40.2

The differential gain of the AD5561 is dependent on the source impedance and load, as shown in Figure 33.

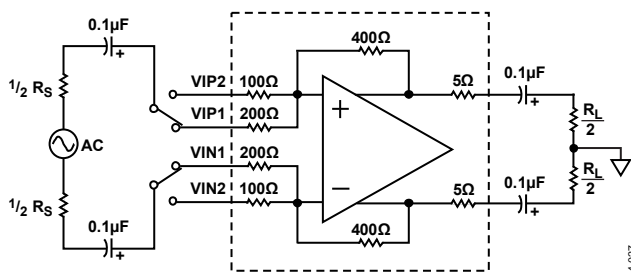

Figure 33. Differential Input Loading Circuit

The differential gain can be determined using the following formula. The values of R_{IN} for each gain configuration are shown in Table 5.

$$A_V = \frac{400}{R_{IN}} \times \frac{R_L}{10 + R_L} \quad (1)$$

Table 5. Values of R_{IN} for Differential Gain

Gain (dB)	R_{IN} (Ω)
6	200
12	100
15.5	66.7

Single-Ended Input to Differential Output

The ADL5561 can also be configured in a single-ended input to differential output driver, as shown in Figure 34. In this configuration, the gain of the part is reduced due to the application of the signal to only one side of the amplifier. The strappable gain values are listed in Table 6 with the required terminations to match to a 50 Ω source using R1 and R2. Note that R1 must equal the parallel value of the source and R2. The input and output 0.1 μF capacitors isolate the VCC/2 bias from the source and the balanced load. The performance for this configuration is shown in Figure 11, Figure 14, and Figure 20.

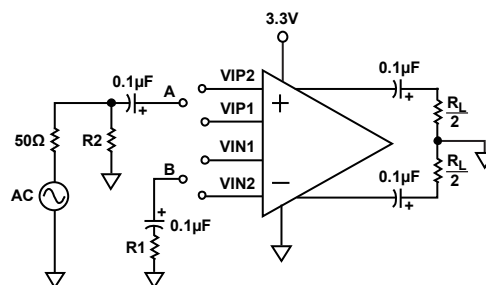

- NOTES
1. FOR 5.6dB GAIN ($A_V = 1.9$), CONNECT INPUT A TO VIP1 AND INPUT B TO VIN1.
 2. FOR 11.1dB GAIN ($A_V = 3.6$), CONNECT INPUT A TO VIP2 AND INPUT B TO VIN2.
 3. FOR 14.1dB GAIN ($A_V = 5.1$), CONNECT INPUT A TO BOTH VIP1 AND VIP2 AND INPUT B TO BOTH VIN1 AND VIN2.

Figure 34. Single-Ended Input to Differential-Output Configuration

Table 6. Single-Ended Termination Values for Figure 34

Gain (dB)	R1 (Ω)	R2 (Ω)
5.6	27	60
11.1	29	69
14.1	30	77

The single-ended gain configuration of the ADL5561 is dependent on the source impedance and load, as shown in Figure 35.

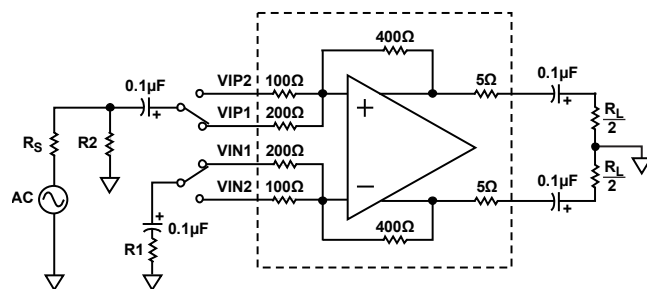

Figure 35. Single-Ended Input Loading Circuit

ADL5561

查询"ADL5561"供应商

The single-ended gain can be determined using the following formula. The values of R_{IN} and R_X for each gain configuration are shown in Table 7.

$$A_{V1} = \frac{400}{R_{IN} + \left(\frac{R_S \times R2}{R_S + R2} \right)} \times \frac{R2}{R_S + R2} \times \frac{R_X + R_S}{R_X} \times \frac{R_L}{10 + R_L} \quad (2)$$

Table 7. Values of R_{IN} and R_X for Single-Ended Gain

Gain (dB)	R_{IN} (Ω)	R_X (Ω)
5.6	200	$R2 \parallel 307^1$
11.1	100	$R2 \parallel 179^1$
14.1	66.7	$R2 \parallel 132^1$

¹ These values are based on a 50 Ω output match.

GAIN ADJUSTMENT AND INTERFACING

The effective gain of the ADL5561 can be reduced using a number of techniques. A matched attenuator network can reduce the effective gain, but this requires the addition of a separate component that can be prohibitive in size and cost. Instead, a simple voltage divider can be implemented using the combination of an addition series resistor at the amplifier input and the input impedance of the ADL5561, as shown in Figure 36. A shunt resistor is used to match to the impedance of the previous stage.

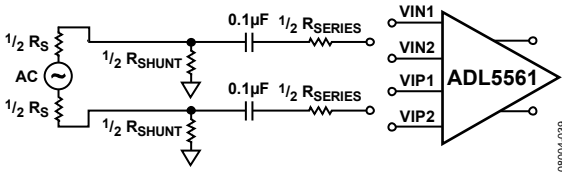

Figure 36. Gain Adjustment Using Series Resistor

Figure 36 shows a typical implementation of the divider concept that effectively reduces the gain by adding attenuation at the input. For frequencies less than 100 MHz, the input impedance of the ADL5561 can be modeled as a real 133 Ω , 200 Ω , or 400 Ω resistance (differential) for maximum, middle, and minimum gains, respectively. Assuming that the frequency is low enough to ignore the shunt reactance of the input and high enough so that the reactance of moderately sized ac-coupling capacitors can be considered negligible, the insertion loss, IL , due to the shunt divider can be expressed as

$$IL(dB) = 20 \log \left(\frac{R_{IN}}{R_{SERIES} + R_{IN}} \right) \quad (3)$$

The necessary shunt component, R_{SHUNT} , to match to the source impedance, R_S , can be expressed as

$$R_{SHUNT} = \frac{1}{\frac{1}{R_S} - \frac{1}{R_{SERIES} + R_{IN}}} \quad (4)$$

The insertion loss and the resultant power gain for multiple shunt resistor values are summarized in Table 8. The source resistance and input impedance need careful attention when using Equation 3 and Equation 4. The reactance of the input impedance of the ADL5561 and the ac-coupling capacitors must be considered before assuming they make a negligible contribution.

Table 8. Gain Adjustment Using Series Resistors

IL (dB)	R_{IN} (Ω)	R_S (Ω)	R_{SERIES} (Ω)	R_{SHUNT} (Ω)
2	400	50	105	54.9
4	400	50	232	54.9
2	200	50	51.1	61.9
4	200	50	115	59
2	133	50	34.8	71.5
2	400	200	102	332
4	400	200	232	294
2	200	200	51.1	976
4	200	200	115	549
2	400	50	105	54.9
4	400	50	232	54.9
2	200	50	51.1	61.9

ADC INTERFACING

The ADL5561 is a high output linearity amplifier that is optimized for ADC interfacing. There are several options available to the designer when using the ADL5561. Figure 37 shows a simplified wideband interface with the ADL5561 driving the AD9445. The AD9445 is a 14-bit, 125 MSPS ADC with a buffered wideband input.

For optimum performance, the ADL5561 should be driven differentially using an input balun. Figure 37 uses a wideband 1:1 transmission line balun followed by two 34.8 Ω resistors in parallel with the three input impedances (which change with the gain selection of the ADL5561) to provide a 50 Ω differential input impedance. This provides a wideband match to a 50 Ω source. The ADL5561 is ac-coupled from the AD9445 to avoid common-mode dc loading. The 33 Ω series resistors help to improve the isolation between the ADL5561 and any switching currents present at the analog-to-digital sample-and-hold input circuitry. The AD9445 input presents a 2 k Ω differential load impedance and requires a 2 V p-p differential input swing to reach full scale ($V_{REF} = 1$ V).

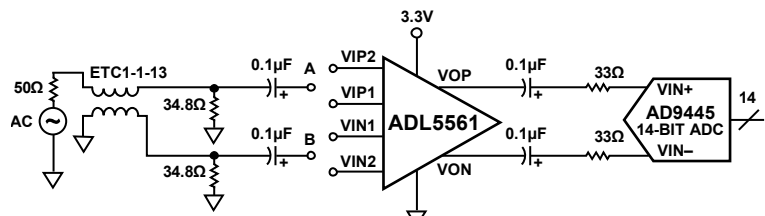

Figure 37. Wideband ADC Interfacing Example Featuring the AD9445

This circuit provides variable gain, isolation, and source matching for the AD9445. Using this circuit with the ADL5561 in a gain of 6 dB, an SFDR performance of 87 dBc is achieved at 140 MHz and a -3 dB bandwidth of 760 MHz, as shown in Figure 38 and Figure 39.

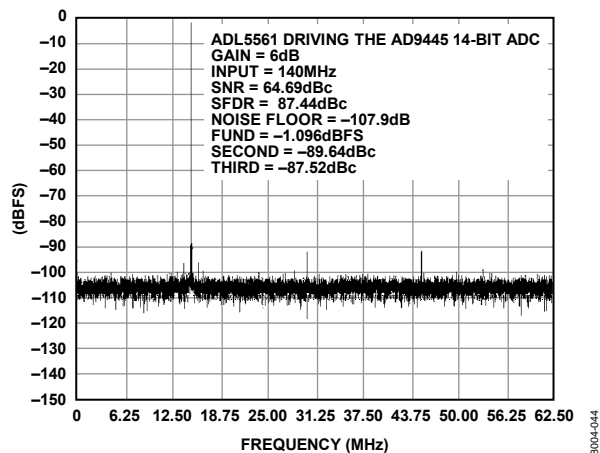

Figure 38. Measured Single-Tone Performance of the Circuit in Figure 37 for a 140 MHz Input Signal

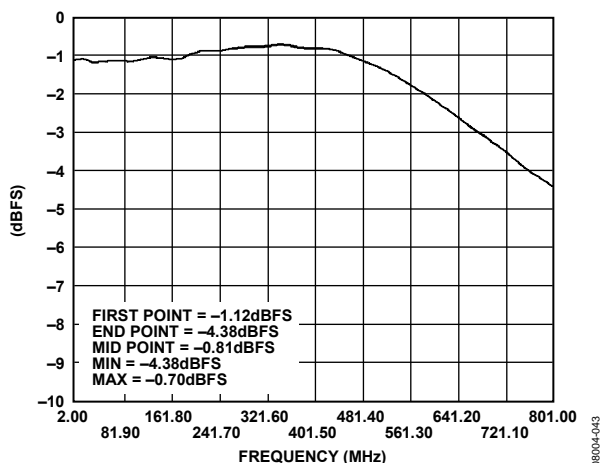

Figure 39. Measured Frequency Response of the Wideband

The wideband frequency response is an advantage in broadband applications, such as predistortion receiver designs and instrumentation applications. However, by designing for a wide analog input frequency range, the cascaded SNR performance is somewhat degraded due to high frequency noise aliasing into the wanted Nyquist zone.

An alternative narrow-band approach is presented in Figure 40. By designing a narrow band-pass antialiasing filter between the ADL5561 and the target ADC, the output noise of the ADL5561 outside of the intended Nyquist zone can be attenuated, helping to preserve the available SNR of the ADC. In general, the SNR improves several decibels when including a reasonable order anti-aliasing filter. In this example, a low loss 1:1 input transformer is used to match the ADL5561 balanced input to a 50 Ω unbalanced source, resulting in minimum insertion loss at the input.

Figure 40 is optimized for driving some of the Analog Devices popular unbuffered ADCs, such as the AD9246, AD9640, and AD6655. Table 9 includes antialiasing filter component recommendations for popular IF sampling center frequencies. Inductor L5 works in parallel with the on-chip ADC input capacitance and a portion of the capacitance presented by C4 to form a resonant tank circuit. The resonant tank helps to ensure that the ADC input looks like a real resistance at the target center frequency. The L5 inductor shorts the ADC inputs at dc, which introduces a zero into the transfer function. In addition, the ac coupling capacitors introduce additional zeros into the transfer function. The final overall frequency response takes on a band-pass characteristic, helping to reject noise outside of the intended Nyquist zone. Table 9 provides initial suggestions for prototyping purposes. Some empirical optimization may be needed to help compensate for actual PCB parasitic.

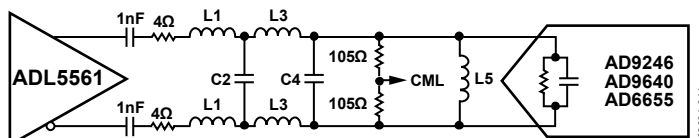

Figure 40. Narrow-Band IF Sampling Solution for an Unbuffered ADC Application

Table 9. Interface Filter Recommendations for Various IF Sampling Frequencies

Center Frequency (MHz)	1 dB Bandwidth (MHz)	L1 (nH)	C2 (pF)	L3 (nH)	C4 (pF)	L5 (nH)
96	30	3.3	47	27	75	100
140	33	3.3	47	27	33	120
170	32	3.3	56	27	22	110
211	33	3.3	47	27	18	56

LAYOUT CONSIDERATIONS

High-Q inductive drives and loads, as well as stray transmission line capacitance in combination with package parasitics, can potentially form a resonant circuit at high frequencies, resulting in excessive gain peaking or possible oscillation. If RF transmission lines connecting the input or output are used, designed them such that stray capacitance at the input/output pins is minimized.

In many board designs, the signal trace widths should be minimal where the driver/receiver is more than one-eighth of the wavelength from the amplifier. This nontransmission line configuration requires that underlying and adjacent ground and low impedance planes be dropped from the signal lines

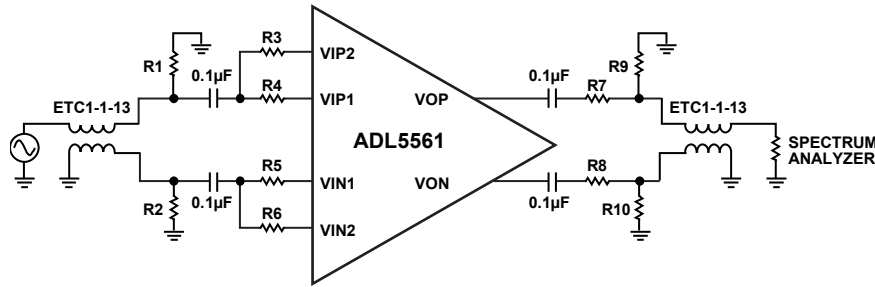

Figure 41. General-Purpose Characterization Circuit

Table 10. Gain Setting and Input Termination Components for Figure 41

A_v (dB)	R1 (Ω)	R2 (Ω)	R3 (Ω)	R4 (Ω)	R5 (Ω)	R6 (Ω)
6 dB	29	29	Open	0	0	Open
12 dB	33	33	0	Open	Open	0
15.5 dB	40.2	40.2	0	0	0	0

Table 11. Output Matching Network for Figure 41

R_L (Ω)	R7 (Ω)	R8 (Ω)	R9 (Ω)	R10 (Ω)
200	84.5	84.5	34.8	34.8
1 k	487	487	25	25

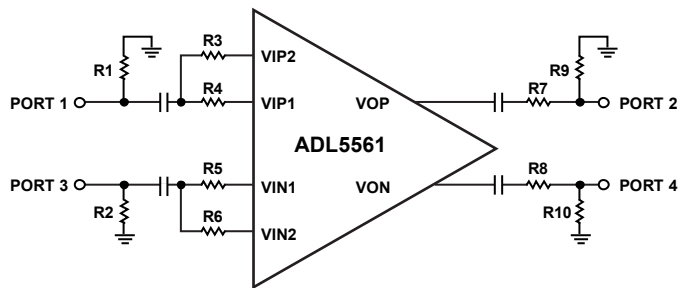

Figure 42. Differential Characterization Circuit Using Agilent E8357A 4-Port PNA

Table 12. Gain Setting and Input Termination Components for Figure 42

A_v (dB)	R1 (Ω)	R2 (Ω)	R3 (Ω)	R4 (Ω)	R5 (Ω)	R6 (Ω)
6	67	67	Open	0	0	Open
12	100	100	0	Open	Open	0
15.5	200	200	0	0	0	0

Table 13. Output Matching Network for Figure 42

R_L (Ω)	R7 (Ω)	R8 (Ω)	R9 (Ω)	R10 (Ω)
200	50	50	Open	Open
1 k	475	475	61.9	61.9

SOLDERING INFORMATION

On the underside of the chip scale package, there is an exposed compressed paddle. This paddle is internally connected to the ground of the chip. Solder the paddle to the low impedance ground plane on the PCB to ensure the specified electrical performance and to provide thermal relief. To further reduce thermal impedance, the ground planes on all layers under the paddle should be stitched together with vias.

EVALUATION BOARD

Figure 43 shows the schematic of the ADL5561 evaluation board. The board is powered by a single supply in the 3 V to 3.6 V range. The power supply is decoupled by 10 μF and 0.1 μF capacitors

Table 14 details the various configuration options of the evaluation board. Figure 44 and Figure 45 show the component and circuit layouts of the evaluation board.

To realize the minimum gain (6 dB into a 200 Ω load), Input 1 (VIN1 and VIP1) must be used by installing 0 Ω resistors at R3 and R4, leaving R5 and R6 open. R1 and R2 must be 33 Ω for a 50 Ω input impedance.

Likewise, driving Input 2 (VIN2 and VIP2) realizes the middle gain (12 dB into a 200 Ω load) by installing 0 Ω at R5 and R6 and leaving R3 and R4 open. R1 and R2 must be 29 Ω for a 50 Ω input impedance.

For the maximum gain (15.5 dB into a 200 Ω load), both inputs are driven by installing 0 Ω resistors at R3, R4, R5, and R6. R1 and R2 must be 40.2 Ω for a 50 Ω input impedance.

The balanced input and output interfaces are converted to single ended with a pair of baluns (M/A-COM ETC1-1-13). The balun at the input, T1, provides a 50 Ω single-ended-to-differential transformation. The output balun, T2, and the matching components are configured to provide a 200 Ω to 50 Ω impedance transformation with an insertion loss of about 17 dB.

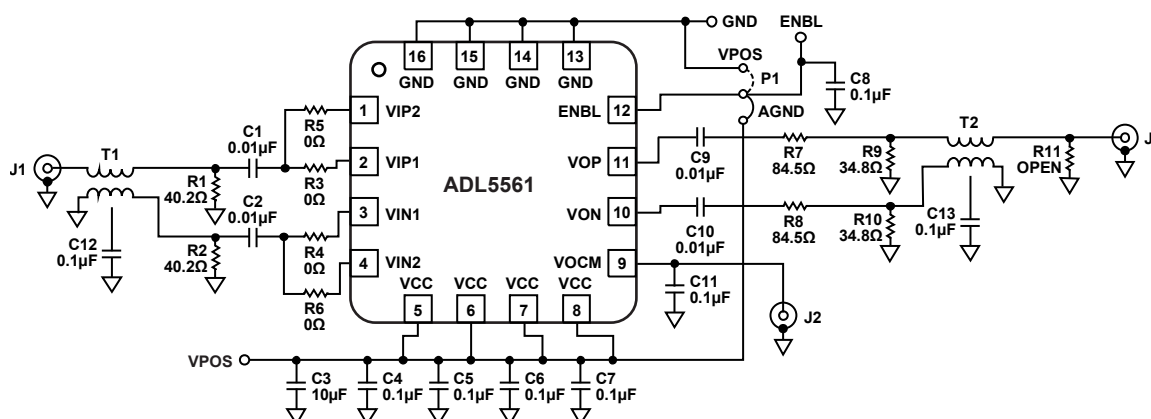
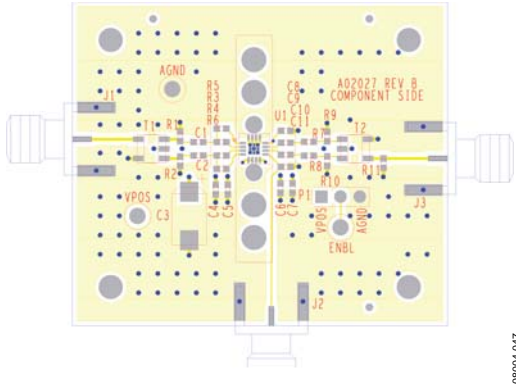

Figure 43. Evaluation Board Schematic

08004-042

Table 14. Evaluation Board Configuration Options

Component	Description	Default Condition
VPOS, GND	Ground and Supply Vector Pins.	VPOS, GND = installed
C3, C4, C5, C6, C7, C11	Power Supply Decoupling. The supply decoupling consists of a 10 μF capacitor (C3) to ground. C4 to C7 are bypass capacitors. C11 ac couples VREF to ground.	C3 = 10 μF (Size D), C4, C5, C6, C7, C11 = 0.1 μF (Size 0402)
J1, R1, R2, R3, R4, R5, R6, C1, C2, C12, T1	Input Interface. The SMA labeled J1 is the input. T1 is a 1-to-1 impedance ratio balun to transform a single-ended input into a balanced differential signal. C1 and C2 provide ac-coupling. C12 is a bypass capacitor. R1 and R2 provide a differential 50 Ω input termination. R3 to R6 are used to select the input for the pin-strappable gain. Maximum gain: R3, R4, R5, R6 = 0 Ω ; R1, R2 = 40.2 Ω . Middle gain: R5, R6 = 0 Ω ; R3, R4 = open; R1, R2 = 33 Ω . Minimum gain: R3, R4 = 0 Ω ; R5, R6 = open; R1, R2 = 29 Ω .	J1 = installed, R1, R2 = 40.2 Ω (Size 0402), R3, R4, R5, R6 = 0 Ω (Size 0402), C1, C2 = 0.01 μF (Size 0402), C12 = 0.1 μF (Size 0402) T1 = ETC1-1-13 (M/A-COM)
J3, R7, R8, R9, R10, R11, C9, C10, C13, T2	Output Interface. The SMA labeled J3 is the output. T2 is a 1-to-1 impedance ratio balun to transform a balanced differential signal to a single-ended signal. C13 is a bypass capacitor. R7, R8, R9, and R10 are provided for generic placement of matching components. The evaluation board is configured to provide a 200 Ω to 50 Ω impedance transformation with an insertion loss of 17 dB. C9 and C10 provide ac-coupling.	J3 = installed, R7, R8 = 84.5 Ω (Size 0402), R9, R10 = 34.8 Ω (Size 0402), R11 = open (Size 0402), C9, C10 = 0.01 μF (Size 0402), C13 = 0.1 μF (Size 0402) T2 = ETC1-1-13 (M/A-COM)
ENBL, P1, C8	Device Enable. C8 is a bypass capacitor. When the P1 jumper is set toward the VPOS label, the ENBL pin is connected to the supply, enabling the device. In the opposite direction, toward the GND label, the ENBL pin is grounded, putting the device in power-down mode.	ENBL, P1 = installed, C8 = 0.1 μF (Size 0402)



08004-047

Figure 44. Layout of Evaluation Board, Component Side

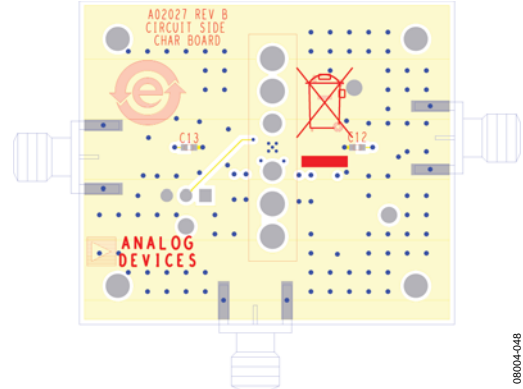

08004-048

Figure 45. Layout of Evaluation Board, Circuit Side

OUTLINE DIMENSIONS

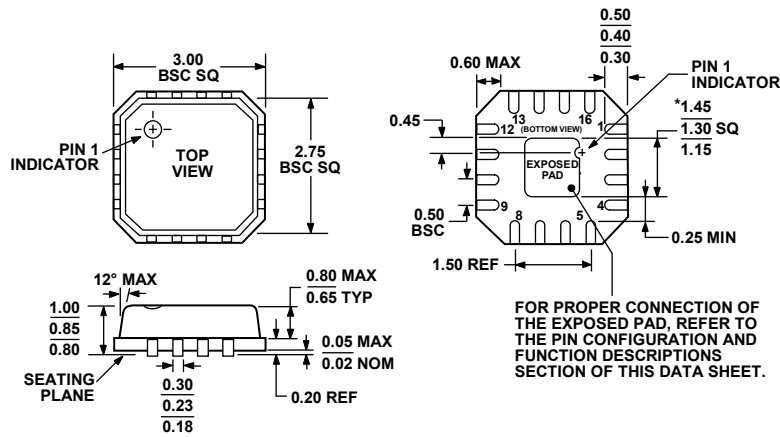

*COMPLIANT TO JEDEC STANDARDS MO-220-VEED-2 EXCEPT FOR EXPOSED PAD DIMENSION.

Figure 46. 16-Lead Lead Frame Chip Scale Package [LFCSP_VQ]
 3 mm × 3 mm Body, Very Thin Quad
 (CP-16-2)
 Dimensions shown in millimeters

072208-A

ORDERING GUIDE

Model ¹	Temperature Range	Package Description	Package Option	Branding	Ordering Quantity
ADL5561ACPZ-R7	-40°C to +85°C	16-Lead Lead Frame Chip Scale Package [LFCSP_VQ], 7" Reel	CP-16-2	Q1P	1,500
ADL5561ACPZ-WP	-40°C to +85°C	16-Lead Lead Frame Chip Scale Package [LFCSP_VQ], Waffle Pack	CP-16-2	Q1P	50
ADL5561-EVALZ		Evaluation Board			

¹ Z = RoHS Compliant Part.

ADL5561

[查询"ADL5561"供应商](#)

NOTES

NOTES

ADL5561

[查询"ADL5561"供应商](#)

NOTES