

V_{SM}	=	6500 V
$I_{T(AV)M}$	=	1405 A
$I_{T(RMS)}$	=	2205 A
I_{TSM}	=	22×10^3 A
V_{T0}	=	1.2 V
r_T	=	0.6 mW

Bi-Directional Control Thyristor

5STB 13N6500

Doc. No. 5SYA1035-03 May 06

- Two thyristors integrated into one wafer
- Patented free-floating silicon technology
- Designed for energy management and industrial applications
- Optimum power handling capability
- Interdigitated amplifying gate.

The electrical and thermal data are valid for one-thyristor-half of the device (unless otherwise stated)

Blocking

Maximum rated values ^{Note 1}

Parameter	Symbol	Conditions	min	typ	max	Unit
Max. surge peak blocking voltage	V_{SM} ¹⁾	$f = 5$ Hz, $t_p = 10$ ms			6500	V
Max. repetitive peak reverse blocking voltage	V_{RM} ¹⁾	$f = 50$ Hz, $t_p = 10$ ms			5600	V
Critical rate of rise of commutating voltage	dv/dt_{crit}	Exp. to 3750 V, $T_{vj} = 125^\circ\text{C}$			2000	V/ μs

Characteristic values

Parameter	Symbol	Conditions	min	typ	max	Unit
Max. leakage current	I_{RM}	V_{RM} , $T_{vj} = 125^\circ\text{C}$			400	mA

1) V_{RM} is equal to V_{SM} up to $T_{vj} = 110^\circ\text{C}$; de-rating of 0.11% per $^\circ\text{C}$ applicable for T_j below $+5^\circ\text{C}$

Mechanical data

Maximum rated values ^{Note 1}

Parameter	Symbol	Conditions	min	typ	max	Unit
Mounting force	F_M		81	90	108	kN
Acceleration	a	Device unclamped			50	m/s^2
Acceleration	a	Device clamped			100	m/s^2

Characteristic values

Parameter	Symbol	Conditions	min	typ	max	Unit
Weight	m				2.9	kg
Housing thickness	H	$F_M = 90$ kN, $T_a = 25^\circ\text{C}$	35		35.6	mm
Surface creepage distance	D_S		53			mm
Air strike distance	D_a		22			mm

Note 1 Maximum rated values indicate limits beyond which damage to the device may occur

ABB Switzerland Ltd, Semiconductors reserves the right to change specifications without notice.



On-state

Maximum rated values ^{Note 1}

Parameter	Symbol	Conditions	min	typ	max	Unit
Average on-state current	$I_{T(AV)M}$	Half sine wave, $T_c = 70\text{ °C}$			1405	A
RMS on-state current	$I_{T(RMS)}$				2205	A
RMS on-state current	$I_{T(RMS)}$	Full sine wave, $T_c = 70\text{ °C}$			3120	A
Peak non-repetitive surge current	I_{TSM}	$t_p = 10\text{ ms}$, $T_{vj} = 125\text{ °C}$, sine wave after surge: $V_D = V_R = 0\text{ V}$			22.0×10^3	A
Limiting load integral	I^2t		2.42×10^6			A^2s
Peak non-repetitive surge current	I_{TSM}	$t_p = 8.3\text{ ms}$, $T_{vj} = 125\text{ °C}$, sine wave after surge: $V_D = V_R = 0\text{ V}$			24.0×10^3	A
Limiting load integral	I^2t		2.39×10^6			A^2s

Characteristic values

Parameter	Symbol	Conditions	min	typ	max	Unit
On-state voltage	V_T	$I_T = 1500\text{ A}$, $T_{vj} = 125\text{ °C}$			2.12	V
Threshold voltage	V_{T0}	$I_T = 670\text{ A} - 2000\text{ A}$, $T_{vj} = 125\text{ °C}$			1.2	V
Slope resistance	r_T		0.6			$m\Omega$
Holding current	I_H	$T_{vj} = 25\text{ °C}$			300	mA
		$T_{vj} = 125\text{ °C}$			175	mA
Latching current	I_L	$T_{vj} = 25\text{ °C}$			500	mA
		$T_{vj} = 125\text{ °C}$			300	mA

Switching

Maximum rated values ^{Note 1}

Parameter	Symbol	Conditions	min	typ	max	Unit
Critical rate of rise of on-state current	di/dt_{crit}	$T_{vj} = 125\text{ °C}$, $I_{TRM} = 2000\text{ A}$, Cont. $f = 50\text{ Hz}$			250	$A/\mu s$
Critical rate of rise of on-state current	di/dt_{crit}	$V_D \leq 3750\text{ V}$, $I_{FG} = 2\text{ A}$, $t_r = 0.5\text{ }\mu s$ Cont. $f = 1\text{ Hz}$			500	$A/\mu s$
Circuit commutated turn-off time	t_q	$T_{vj} = 125\text{ °C}$, $I_{TRM} = 2000\text{ A}$, $V_R = 200\text{ V}$, $di_T/dt = -1.5\text{ A}/\mu s$, $V_D \leq 0.67 \cdot V_{RM}$, $dv_D/dt = 20\text{ V}/\mu s$,	800			μs

Characteristic values

Parameter	Symbol	Conditions	min	typ	max	Unit
Recovery charge	Q_{rr}	$T_{vj} = 125\text{ °C}$, $I_{TRM} = 2000\text{ A}$, $V_R = 200\text{ V}$, $di_T/dt = -1.5\text{ A}/\mu s$	2400		3800	μAs
Recovery charge	I_{RM}		50		70	A
Gate turn-on delay time	t_{gd}	$T_{vj} = 25\text{ °C}$, $V_D = 0.4 \cdot V_{RM}$, $I_{FG} = 2\text{ A}$, $t_r = 0.5\text{ }\mu s$			3	μs

Triggering

Maximum rated values ^{Note 1}

Parameter	Symbol	Conditions	min	typ	max	Unit
Peak forward gate voltage	V_{FGM}				12	V
Max. rated peak forward gate current	I_{FGM}				10	A
Peak reverse gate voltage	V_{RGM}				10	V
Max. rated gate power loss	P_G	For DC gate current			3	W
Max. rated peak forward gate power	P_{GM}		see Fig. 9			

Characteristic values

Parameter	Symbol	Conditions	min	typ	max	Unit
Gate trigger voltage	V_{GT}	$T_{vj} = 25\text{ °C}$			2.6	V
Gate trigger current	I_{GT}	$T_{vj} = 25\text{ °C}$			400	mA
Gate non-trigger voltage	V_{GD}	$V_D = 0.4 \times V_{RM}$, $T_{vj} = 125\text{ °C}$	0.3			V
Gate non-trigger current	I_{GD}	$V_D = 0.4 \times V_{RM}$	10			mA

Thermal

Maximum rated values ^{Note 1}

Parameter	Symbol	Conditions	min	typ	max	Unit
Operating junction temperature range	T_{vj}				125	°C
Storage temperature range	T_{stg}		-40		140	°C

Characteristic values

Parameter	Symbol	Conditions	min	typ	max	Unit
Thermal resistance junction to case (Valid for one thyristor half no heat flow to the second half.)	$R_{th(j-c)}$	Double-side cooled $F_m = 81...108\text{ kN}$			11.4	K/kW
	$R_{th(j-c)A}$	Anode-side cooled $F_m = 81...108\text{ kN}$			22.8	K/kW
	$R_{th(j-c)C}$	Cathode-side cooled $F_m = 81...108\text{ kN}$			22.8	K/kW
Thermal resistance case to heatsink	$R_{th(c-h)}$	Double-side cooled $F_m = 81...108\text{ kN}$			2	K/kW
	$R_{th(c-h)}$	Single-side cooled $F_m = 81...108\text{ kN}$			4	K/kW

Analytical function for transient thermal impedance:

$$Z_{th(j-c)}(t) = \sum_{i=1}^n R_i (1 - e^{-t/\tau_i})$$

i	1	2	3	4
R_i (K/kW)	6.770	2.510	1.340	0.780
τ_i (s)	0.8651	0.1558	0.0212	0.0075

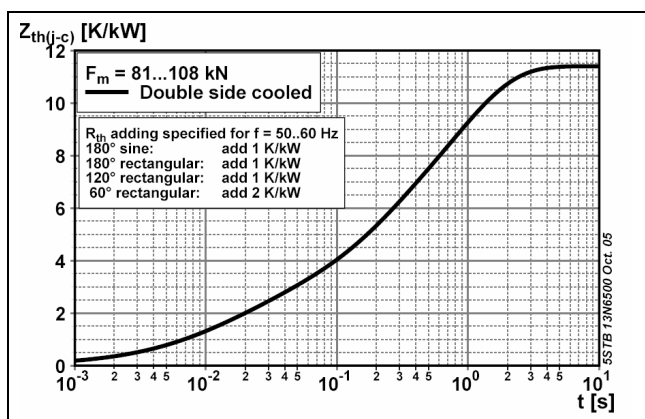

Fig. 1 Transient thermal impedance junction-to-case

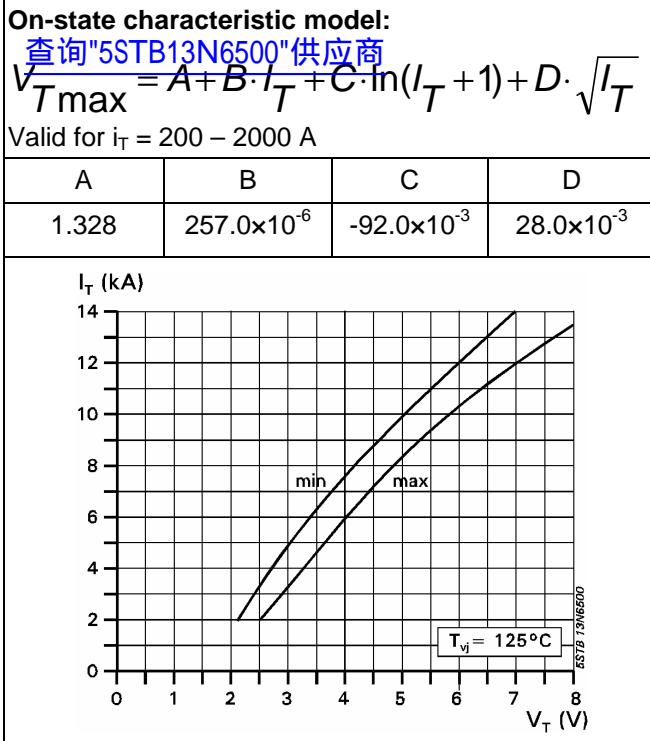

Fig. 2 On-state characteristics, $T_j = 125^\circ\text{C}$, 10ms half sine

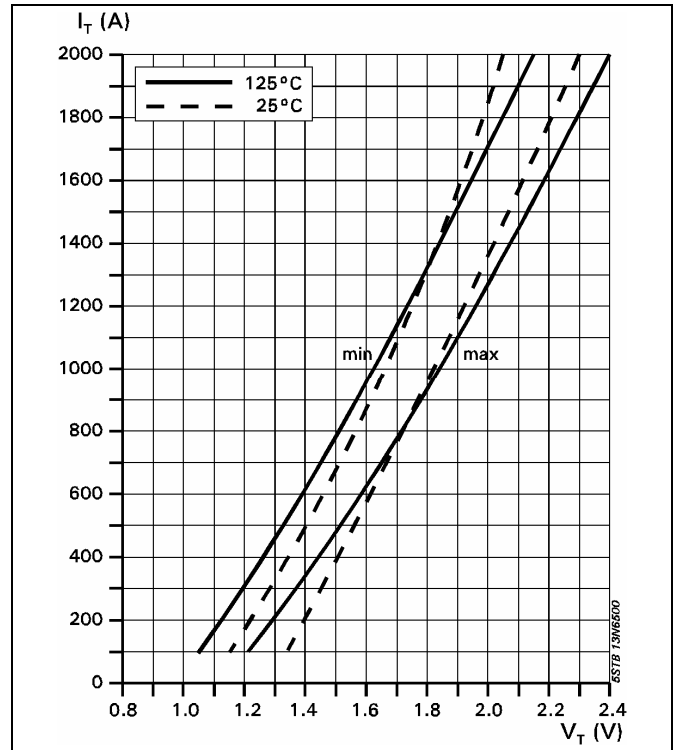

Fig. 3 On-state voltage characteristics

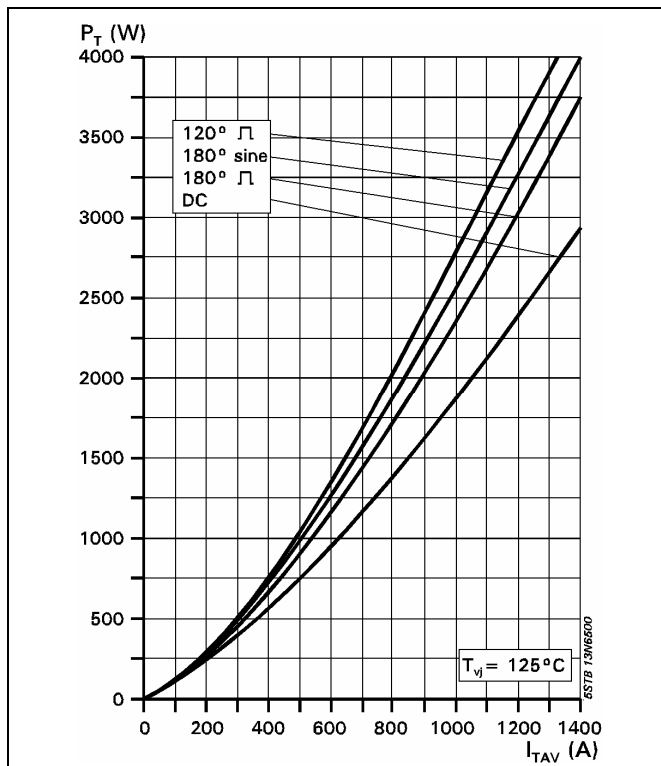

Fig. 4 On-state power dissipation vs. mean on-state current. Switching losses excluded.

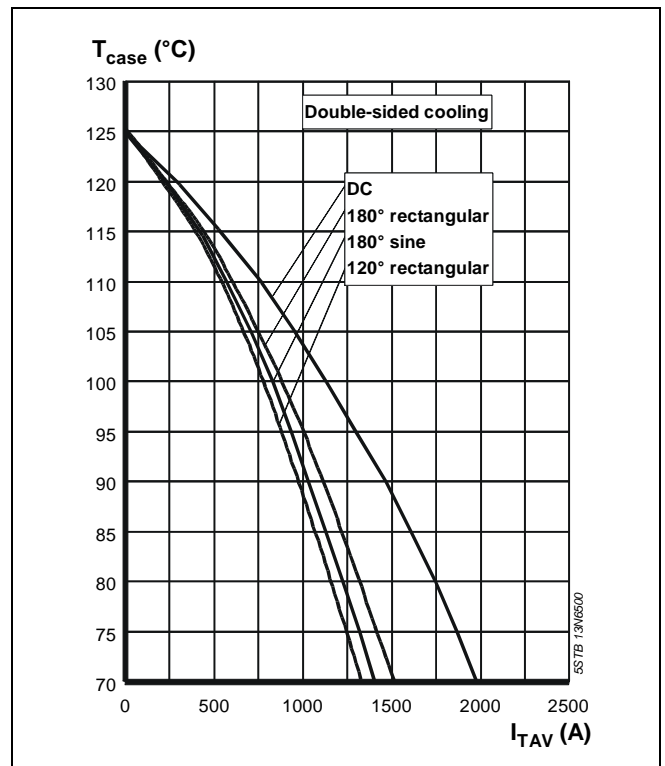

Fig. 5 Max. permissible case temperature vs. mean on-state current. Switching losses ignored.

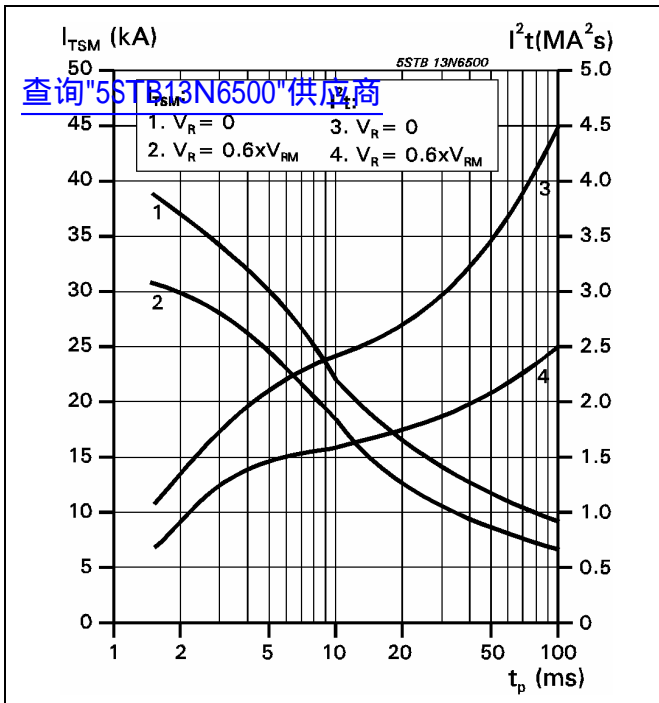

Fig. 6 Surge on-state current vs. pulse length. Half-sine wave.

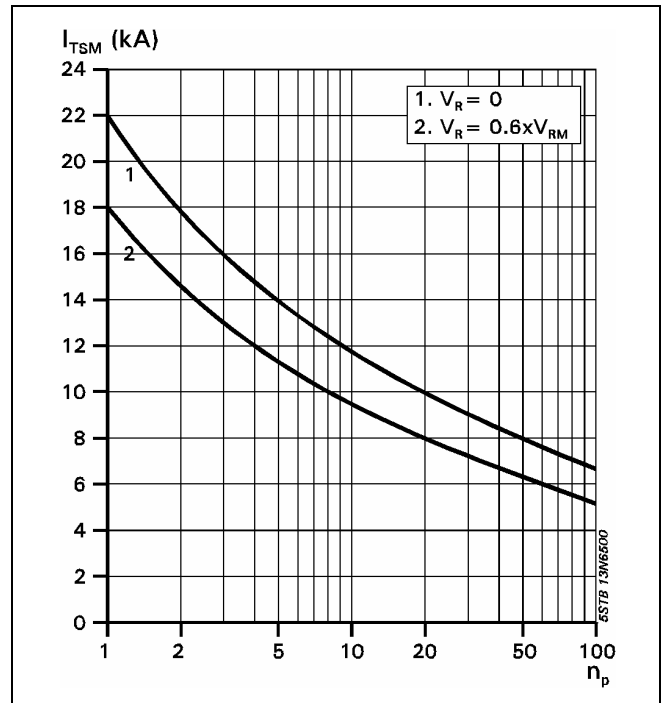

Fig. 7 Surge on-state current vs. number of pulses. Half-sine wave, 10 ms, 50Hz.

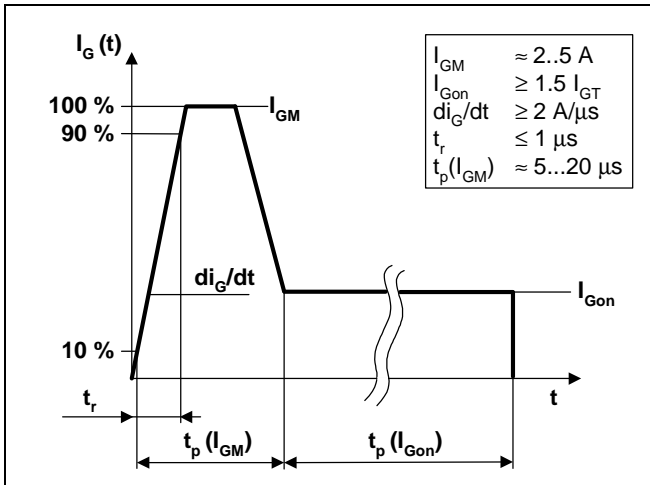

Fig. 8 Recommended gate current waveform

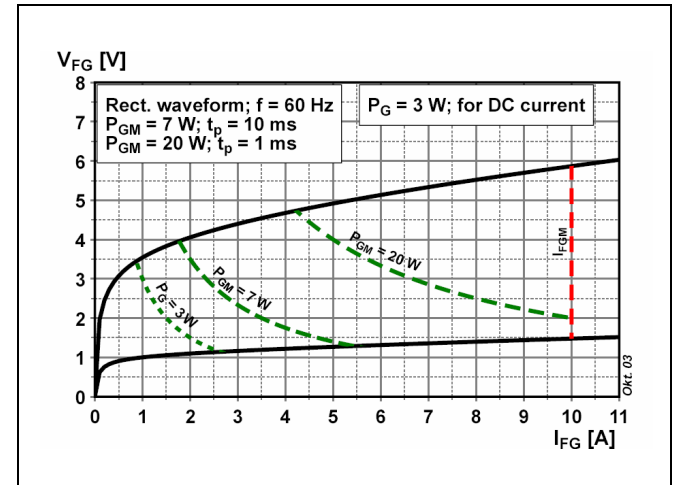

Fig. 9 Max. peak gate power loss

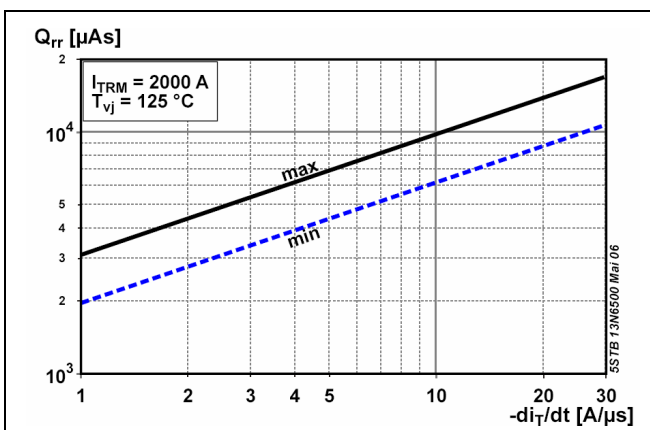

Fig. 10 Recovery charge vs. decay rate of on-state current

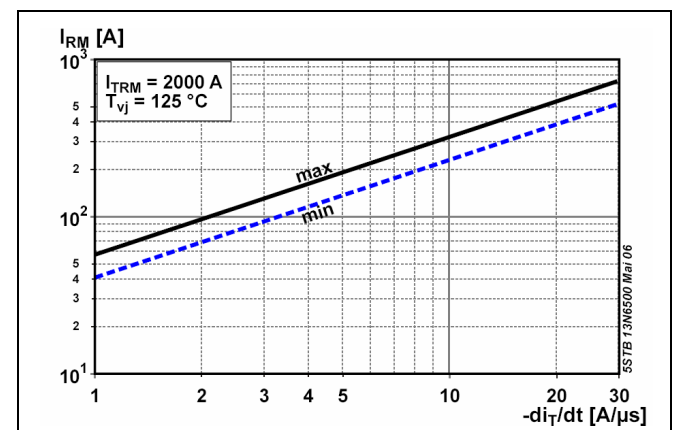

Fig. 11 Peak reverse recovery current vs. decay rate of on-state current

Turn-on and Turn-off losses

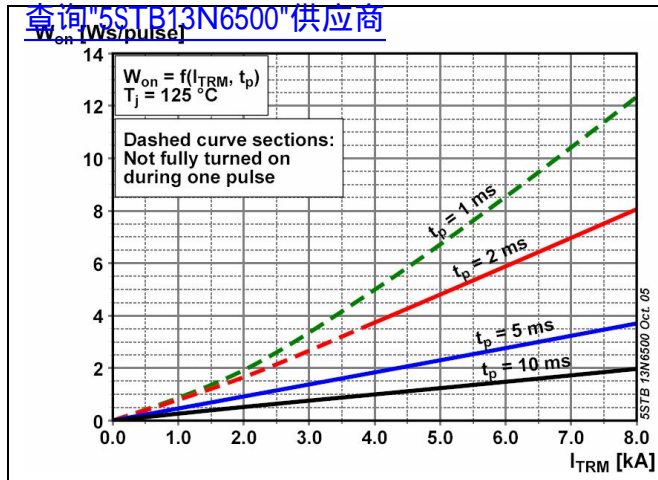

Fig. 12 Turn-on energy, half sinusoidal waves

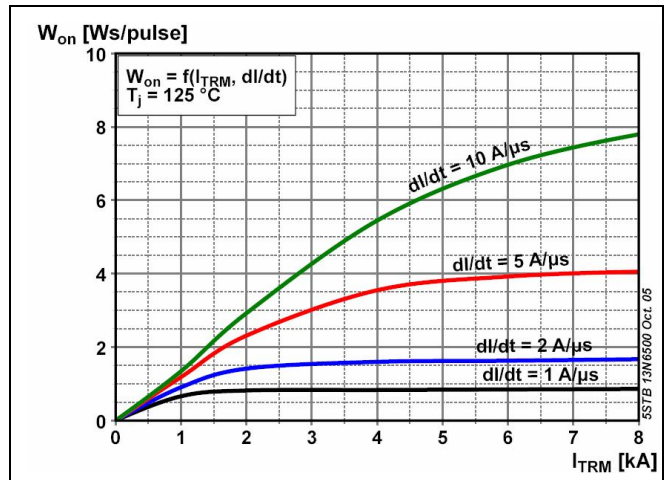

Fig. 13 Turn-on energy, rectangular waves

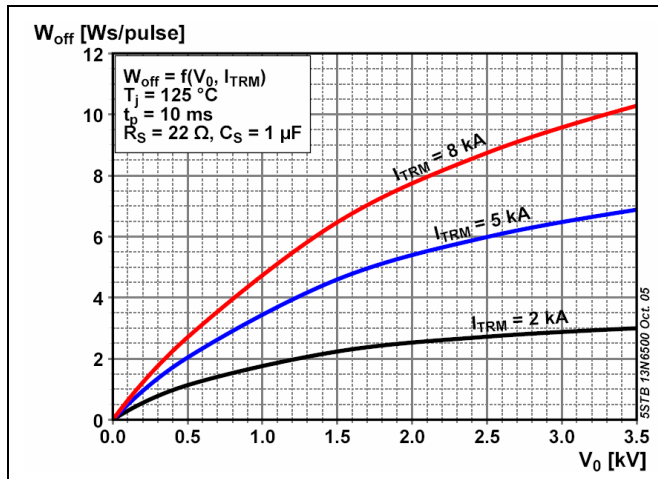

Fig. 14 Turn-off energy, half sinusoidal waves

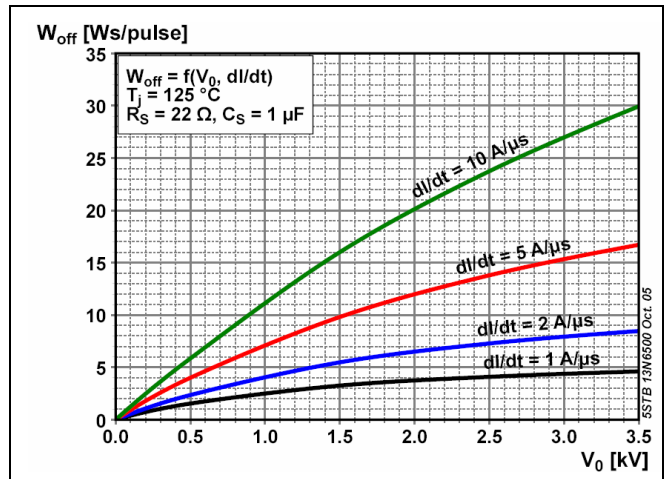

Fig. 15 Turn-off energy, rectangular waves

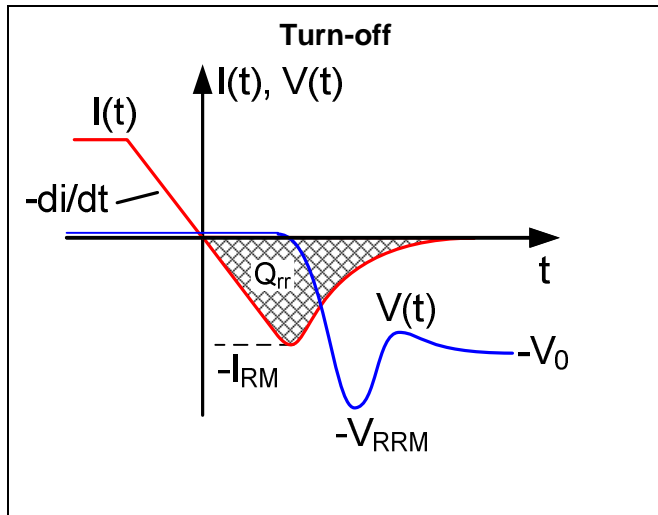

Fig. 16 Current and voltage waveforms at turn-off

Total power loss for repetitive waveforms:

$$P_{TOT} = P_T + W_{on} \cdot f + W_{off} \cdot f$$

where

$$P_T = \frac{1}{T} \int_0^T I_T \cdot V_T(I_T) dt$$

Fig. 17 Relationships for power loss

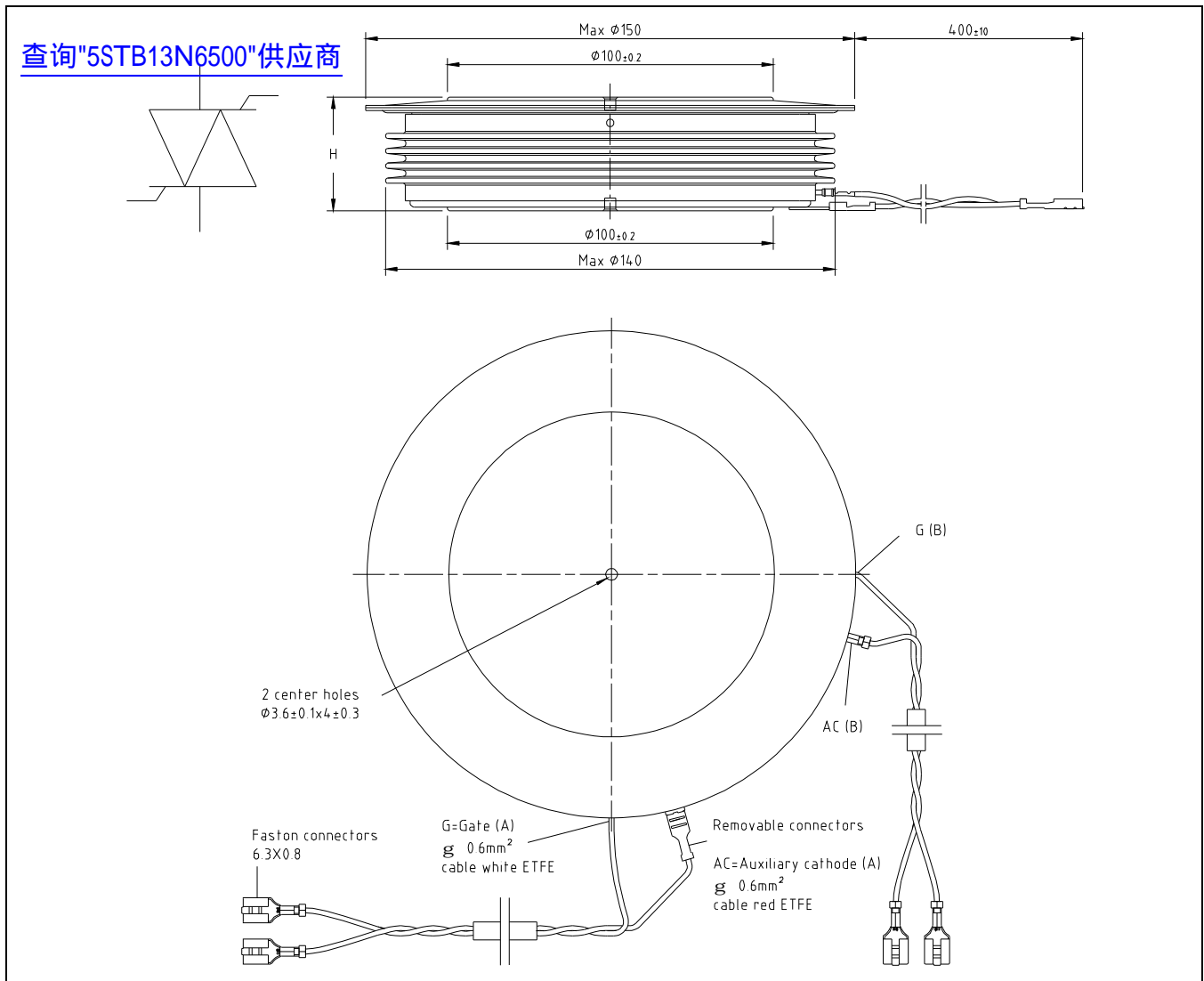

Fig. 18 Device Outline Drawing

Related documents:

- | | |
|-----------|---|
| 5SYA 2020 | Design of RC-Snubber for Phase Control Applications |
| 5SYA 2034 | Gate-Drive Recommendations for PCT's |
| 5SYA 2036 | Recommendations regarding mechanical clamping of Press Pack High Power Semiconductors |
| 5SZK 9104 | Specification of environmental class for pressure contact diodes, PCTs and GTO, STORAGE available on request, please contact factory |
| 5SZK 9105 | Specification of environmental class for pressure contact diodes, PCTs and GTO, TRANSPORTATION available on request, please contact factory |

Please refer to <http://www.abb.com/semiconductors> for actual versions.

ABB Switzerland Ltd, Semiconductors reserves the right to change specifications without notice.

ABB

ABB Switzerland Ltd
Semiconductors
 Fabrikstrasse 3
 CH-5600 Lenzburg, Switzerland

Doc. No. 5SYA1035-03 May 06

Telephone +41 (0)58 586 1419
 Fax +41 (0)58 586 1306
 Email abbsem@ch.abb.com
 Internet www.abb.com/semiconductors