

SAW Bandpass Filter 253301B

1. Features

- IF bandpass filter
- High attenuation
- Single-ended operation
- DIP Package
- Maximum Storage Temperature Range : -40°C ~ 85°C
- Electrostatics Sensitive Device (ESD)

2. Package Dimension

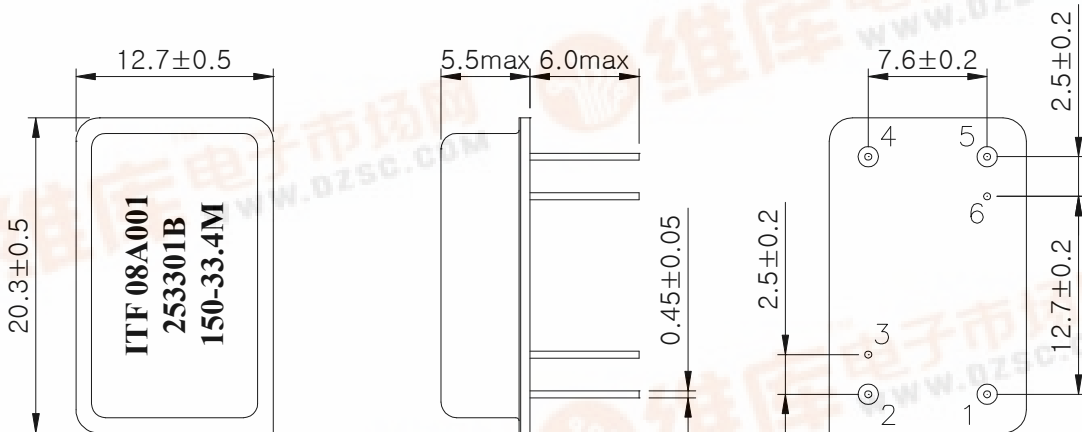

Package : D2012

Dimensions shown are nominal in millimeters

Base : Fe(SPCC), Au plating over Ni plated

Cap : Cu & Cr Alloy, Ni Plated

Termination : Kovar, Au Plated

Pin Configuration	
1	Input
5	Output
2, 4	Ground
3, 6	Case ground

	ITF Co., Ltd. 102-901, Bucheon Technopark 364, Samjeong-Dong, Ojeong-Gu, Bucheon-City, Gyeonggi-Do, Korea 421-809	Part No.	253301B	
		Rev. Date	2008-02-28	
		Rev.	NM8005-CS01	1/5

SAW Bandpass Filter 253301B

3. Specifications

Fo = 150.0 MHz

Terminating source impedance : 50Ω and matching network

Terminating load impedance : 50Ω and matching network

		Minimum	Typical	Maximum
Center Frequency	MHz	-	150.0	-
Insertion Loss	dB	-	28.6	30.0
1dB Bandwidth	MHz	33.2	33.35	-
3dB Bandwidth	MHz	-	33.65	-
30dB Bandwidth	MHz	-	34.81	35.0
40dB Bandwidth	MHz	-	35.02	-
Amplitude Ripple (fo±16.3 MHz)	dB	-	0.53	1.0
Group Delay Variation (fo±16.3 MHz)	nsec	-	25	50
Absolute Delay	usec	-	2.03	-
Ultimate Rejection	dB	45	48	-
Temperature Coefficient of Frequency	ppm/°C	-	-72	-

Notes :

- 1) All specifications are based on the matching schematic shown below
- 2) All specifications are measured by Agilent Network analyzer and full 2 port calibration at room temperature
- 3) All attenuation measurements are measured relative to insertion loss

 Integrated Technology Future	ITF Co., Ltd. 102-901, Bucheon Technopark 364, Samjeong-Dong, Ojeong-Gu, Bucheon-City, Gyeonggi-Do, Korea 421-809	Part No.	253301B	
		Rev. Date	2008-02-28	
		Rev.	NM8005-CS01	2/5

SAW Bandpass Filter 253301B

4. Matching Schematic

(Actual matching values may vary due to PCB layout and parasitics)

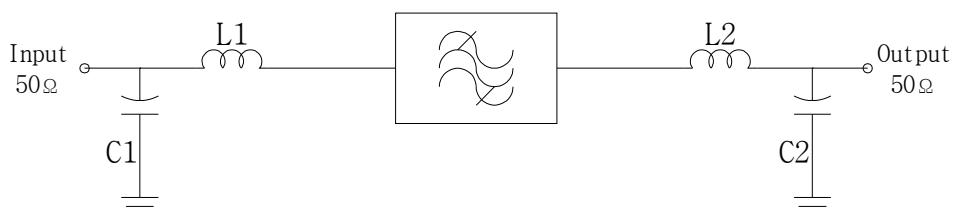

L1 = 33nH, L2 = 33nH

C1 = 27pF, C2 = 24pF

5. Marking Configuration

ITF¹⁾ 08A001²⁾

253301B³⁾

150⁴⁾ -33.4M⁵⁾

- 1) Manufacturer name
- 2) Lot Number
- 3) Part Number
- 4) Center Frequency
- 5) 1dB-Bandwidth

 Integrated Technology Future	ITF Co., Ltd. 102-901, Bucheon Technopark 364, Samjeong-Dong, Ojeong-Gu, Bucheon-City, Gyeonggi-Do, Korea 421-809	Part No.	253301B	
		Rev. Date	2008-02-28	
		Rev.	NM8005-CS01	3/5

SAW Bandpass Filter 253301B



6. Typical Performance (at +25°C)

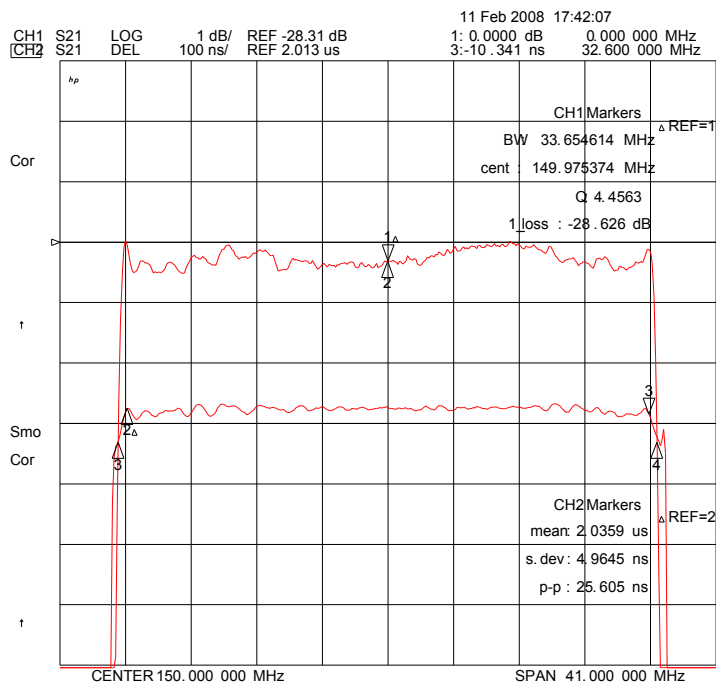
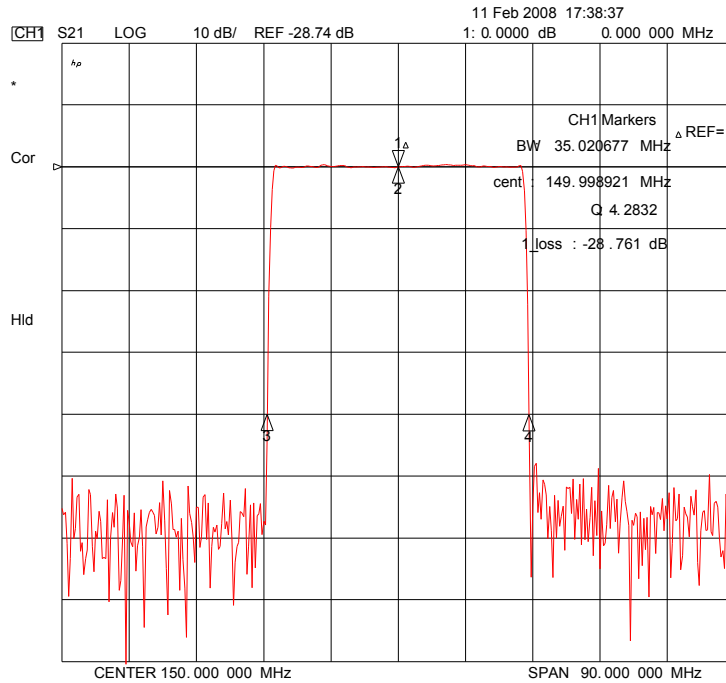

ITF Co., Ltd.
 102-901, Bucheon Technopark 364,
 Samjeong-Dong, Ojeong-Gu, Bucheon-City,
 Gyeonggi-Do, Korea 421-809

Part No. 253301B

Rev. Date 2008-02-28

Rev. NM8005-CS01 4/5

SAW Bandpass Filter 253301B

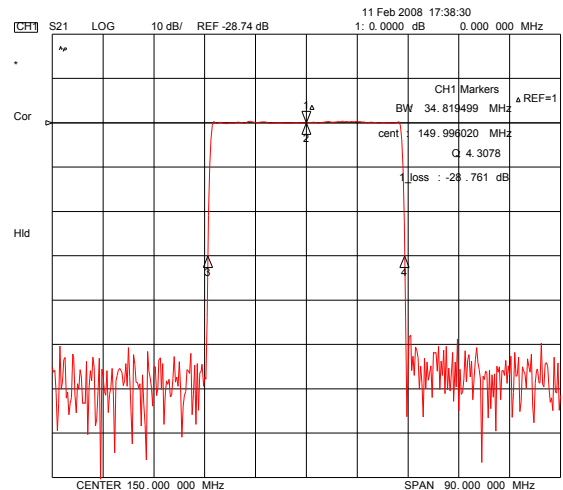
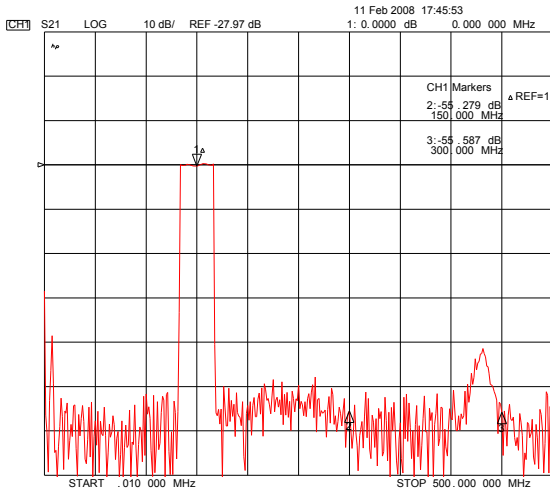
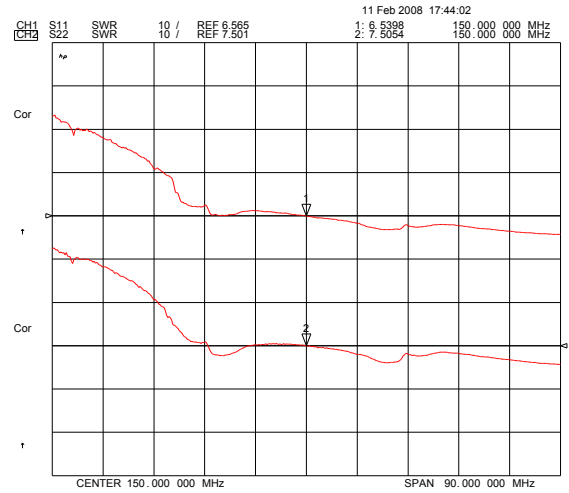
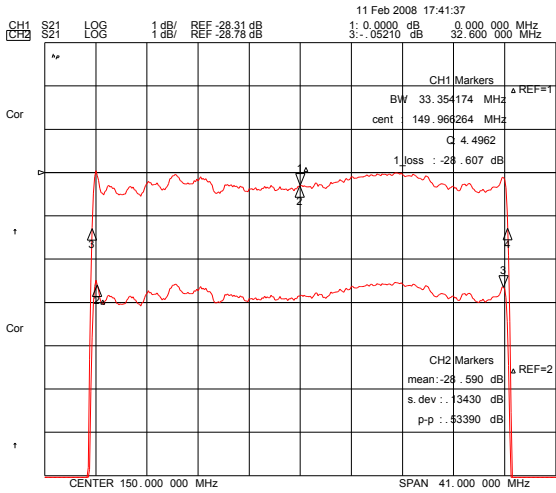

ITF Co., Ltd.
 102-901, Bucheon Technopark 364,
 Samjeong-Dong, Ojeong-Gu, Bucheon-City,
 Gyeonggi-Do, Korea 421-809

Part No.	253301B	
Rev. Date	2008-02-28	
Rev.	NM8005-CS01	5/5