

PREPARED BY : DATE
A.Ogino Oct.21.2003

[查询"LQ035Q7DH01"供应商](#)

APPROVED BY : DATE

S H A R P

MOBILE LIQUID CRYSTAL DISPLAY GROUP
SHARP CORPORATION

S P E C I F I C A T I O N

SPEC No. LCP-03015A

FILE No.

ISSUE : Oct. 21. 2003

PAGE : 24 pages

Design Center
MOBILE LCD Enterprise
Development Center

DEVICE SPECIFICATION FOR

TFT-LCD module

MODEL No. LQ035Q7DH01

CUSTOMER'S APPROVAL

DATA _____

BY _____

PRESENTED

BY

H. NAKATSUJI

DEPARTMENT GENERAL MANAGER
Development Department V
Design Center I
MOBILE LCD Enterprise development Center
MOBILE LCD GROUP
SHARP CORPORATION

This publication is the proprietary of SHARP and is copyrighted, with all rights reserved. Under the copyright laws, no part of this publication may be reproduced or transmitted in any form or by any means, electronic or mechanical for any purpose, in whole or in part, without the express written permission of SHARP. Express written permission is also required before any use of this publication may be made by a third party.

The application circuit examples in this publication are provided to explain the representative applications of SHARP's devices and are not intended to guarantee any circuit design or permit any industrial property right or other rights to be executed. SHARP takes no responsibility for any problems related to any industrial property right or a third party resulting from the use of SHARP's devices, except for those resulting directly from device manufacturing processes.

In the absence of confirmation by device specification sheets, SHARP takes no responsibility for any defects that occur in equipment using any of SHARP's devices, shown in catalogs, data books, etc. Contact SHARP in order to obtain the latest device specification sheets before using any SHARP's device.

SHARP reserves the right to make changes in the specifications, characteristics, data, materials, structures and other contents described herein at any time without notice in order to improve design or reliability. Contact SHARP in order to obtain the latest specification sheets before using any SHARP's device. Manufacturing locations are also subject to change without notice.

Observe the following points when using any device in this publication. SHARP takes no responsibility for damage caused by improper use of the devices.

The devices in this publication are designed for use in general electronic equipment designs, such as:

- Personal computers • Office automation • Telecommunication equipment
- Test and measurement equipment • Industrial control
- Audio visual and multimedia equipment • Consumer electronics

The appropriate design measures should be taken to ensure reliability and safety when SHARP's devices are used for equipment such as:

- Transportation control and safety equipment(i.e., aircraft, trains, automobiles, etc.)
- Traffic signals • Gas leakage sensor breakers
- Alarm equipment • Various safety devices etc.

SHARP's devices shall not be used for equipment that requires extremely high level of reliability, such as:

- Military and space applications • Nuclear power control equipment
- Medical equipment for life support

Contact a SHARP representative, in advance, when intending to use SHARP's devices for any "specific" applications other than those recommended by SHARP.

Contact and consult with a SHARP representative if there are any questions about the contents of this publication.

[查询"LQ035Q7DH01"供应商](#)

This specification applies to LQ035Q7DH01

(2) Overview

This module is a color active matrix LCD module incorporating amorphous silicon TFT (Thin Film Transistor), named AD-TFT(Advanced TFT). It is practicable in both transmissive-type and reflection-type modes. It is composed of a color TFT-LCD panel, driver ICs, an FPC, a back light, a touch panel and a back sealed casing. It isn't composed control circuit. Graphics and texts can be displayed on a 240 × 3 × 320 dots panel with 262,144 colors by supplying.

Optimum view angle is 6 o'clock. An inverted display mode is selective in the vertical or the horizontal direction.

(3) Mechanical specifications

Table 1

Parameter	Specifications	Units	Remarks
Screen size (Diagonal)	8.9 [3.52 "] Diagonal	cm	
Display active area	53.64 (H) × 71.52 (V)	mm	
Pixel format	240(H) × 320(V) (1 pixel = R+G+B dots)	pixels	
Pixel pitch	0.2235 (H) × 0.2235 (V)	mm	
Pixel configuration	R,G,B vertical stripe		
Unit outline dimension	65.0(W) × 86.2(H) × 4.0 (D)	mm	【Note3-1】
Mass	45	g	TYP.
Surface hardness	3H		

【Note 3-1】

Excluding protrusion. Including FPC cover portion
For detailed measurements and tolerances, please refer to Fig. 1.

(4)Pixel configuration

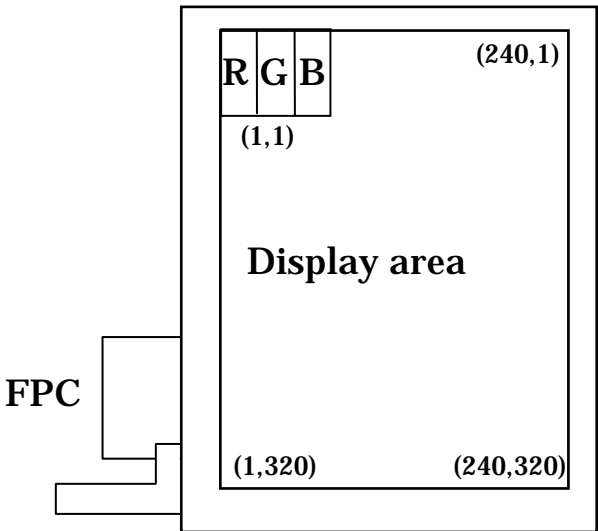

查询"LC035Q7DH01"供应商

Input/Output terminal

5-1)TFT-LCD panel driving section

Table2

Recommendation CN : FH12A-50S-0.5SH(HIROSE)

Pin No.	Symbol	I/O	Description	Remarks
1	VL1	I	Power supply for LED (High voltage)	
2	NC	-		
3	VL2	I	Power supply for LED (Low voltage)	
4	VEE	-	Power supply of gate driver(low level)	
5	VSHD	-	Power supply of digital	
6	DGND	-	Ground(digital)	
7	CLS	I	Clock signal of gate driver	
8	DGND	-	Ground(digital)	
9	SPS	I	Start signal of gate driver	
10	U/L	I	Selection for vertical scanning direction	【 Note5-1 】
11	MOD	I	Control signal of gate driver	【 Note5-2 】
12	VDD	-	Power supply of gate driver(high level)	
13	VCOM	I	Common electrode driving signal	
14	DGND	-	Ground(digital)	
15	SPR	I/O	Sampling start signal	
16	DGND	-	Ground(digital)	
17	VSHA	-	Power supply(analog)	
18	LBR	I	Selection for horizontal scanning direction	【 Note5-3 】
19	PS	I	Power save signal (Please don't carry out use by "Low" fixation)	
20	REV	I	reverse control signal	【 Note5-4 】
21	DGND	-	Ground(digital)	
22	B5	I	BLUE data signal(MSB)	
23	B4	I	BLUE data signal	
24	B3	I	BLUE data signal	
25	B2	I	BLUE data signal	
26	B1	I	BLUE data signal	
27	B0	I	BLUE data signal(LSB)	
28	LP	I	Data latch signal of source driver	
29	DGND	-	Ground(digital)	
30	SPL	I/O	Sampling start signal	
31	DGND	-	Ground(digital)	
32	DCLK	I	Data sampling clock signal	
33	DGND	-	Ground(digital)	
34	G5	I	GREEN data signal(MSB)	
35	G4	I	GREEN data signal	
36	G3	I	GREEN data signal	
37	G2	I	GREEN data signal	
38	G1	I	GREEN data signal	
39	G0	I	GREEN data signal(LSB)	

[查询"LQ035Q7DH01"供应商](#)

Pin No.	Symbol	I/O	Description	Remarks
40	DGND	-	Ground(digital)	
41	R5	I	RED data signal(MSB)	
42	R4	I	RED data signal	
43	R3	I	RED data signal	
44	R2	I	RED data signal	
45	R1	I	RED data signal	
46	R0	I	RED data signal(LSB)	
47	AGND	-	Ground(analog)	
48	COM	O	Produce REV signal with the amplitude of AGND - VSHA	【Note5-4】
49	DGND	-	Ground(digital)	
50	DGND	-	Ground(digital)	

【Note5-1】 Selection for vertical scanning direction

U/L	Scanning direction (Pixel configuration)
Low	Normal scanning (X , 1) (X , 320)
High	Inverted scanning (X , 1) (X , 320)

【Note5-2】 See section(7-1)-(A) ” Cautions when you turn on or off the power supply”.

【Note5-3】 Selection for horizontal scanning direction

LBR	SPL	SPR	Scanning direction (Pixel configuration)
High	Input	Output	Normal scanning (1,Y) (240,Y)
Low	Output	Input	Inverted scanning (1,Y) (240,Y)

【Note5-4】

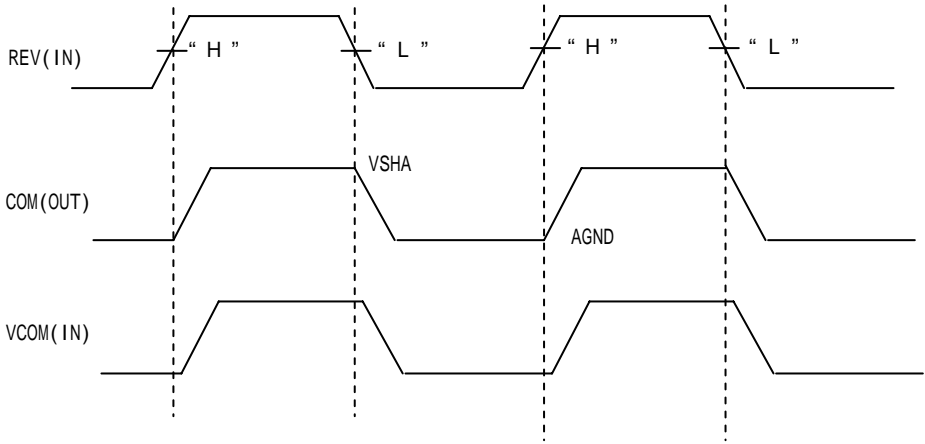

[查询"LQ035Q7DH01"供应商](#)

5-2)Touch panel driving section

Table 4

Recommendation CN : 0.4(1.0)9FLH-RSM1-TB (JST) △

Pin No.	Symbol	I/O	Description	Remark
T1	YU	-	Y (12 o'clock side)	
T2	XL	-	X (right side)	△
T3	YD	-	Y (6 o'clock side)	
T4	XR	-	X (left side)	△

(6)Absolute Maximum Ratings

Table 5

Parameter	Symbol	Condition	Ratings	Unit	Remark
Power supply(source/Analog)	VSHA	Ta=25	-0.3 ~ +7.0	V	
Power supply(source/Digital)	VSHD	Ta=25	-0.3 ~ +7.0	V	
Power supply (gate)	VDD	Ta=25	-0.3 ~ +35.0	V	
Power supply (gate)	VDD-VEE	Ta=25	-0.3 ~ +35.0	V	
Input voltage (Digital)	VID	Ta=25	-0.3 ~ VSHD+0.3	V	[Terminal]
Operating temperature (panel surface)	T opp	-	-10 ~ 70		【Note6】
Storage temperature	T stg	-	-25 ~ 70		【Note6-2】

[Terminal] MOD,U/L,SPS,CLS,SPL,R0 ~ R5,G0 ~ G5,B0 ~ B5,LP,DCLK,LBR,SPR,PS,REV

【Note6-2】 Humidity: 95%RH Max.(at Ta 40). Maximum wet-bulb temperature is less than 39 (at Ta > 40). Condensation of dew must be avoided.

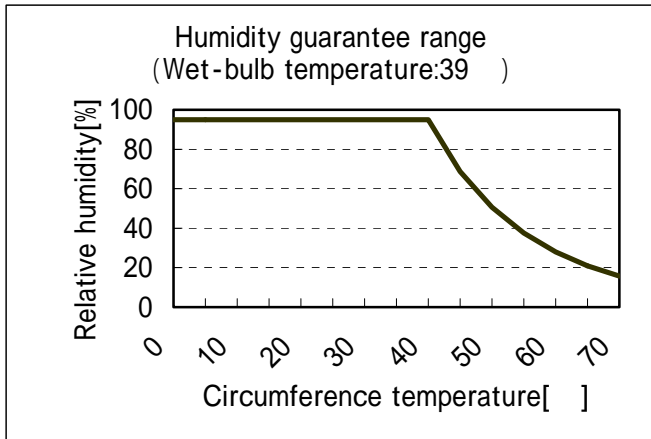

The maximum humidity in the temperature

7) Electrical Characteristics

7-1) Recommended operating conditions

A) TFT-LCD panel driving section

Table 6

GND=0V

Parameter		Symbol	Min.	Typ.	Max.	Unit	Remarks
Supply voltage for source driver (Analog)		VSHA	+4.5	+5.0	+5.5	V	
Supply voltage for source driver (Digital)		VSHD	+3.0	+3.3	+3.6	V	
Supply voltage for gate driver	High voltage	VDD	+14.5	+15.0	+15.5	V	
	Low voltage	VEE	-10.5	-10.0	-9.5	V	
Input voltage for Source driver (Low)		VILS	GND	-	0.2VSHD	V	【Note 7-1】
Input voltage for Source driver (High)		VIHS	0.8VSHD	-	VSHD	V	【Note 7-1】
Input current for Source driver (Low)		IILS	-	-	30	μA	【Note 7-1】
Input current for Source driver (High)	IHS1	-	-	-	30	μA	【Note 7-2】
	IHS2	-	-	-	1200	μA	【Note 7-3】
Input voltage for Gate driver (Low)		VILG	GND	-	0.2VSHD	V	【Note 7-4】
Input voltage for Gate driver (High)		VIHG	0.8VSHD	-	VSHD	V	【Note 7-4】
Input current for Gate driver (Low)		IILG	-	-	4	μA	【Note 7-4】
Input current for Gate driver (High)		IIHG	-	-	4	μA	【Note 7-4】
Common electrode driving signal	AC component	VCOMAC	-	± 2.5	± 2.6	Vp-p	【Note 7-5】
	DC component	VCOMDC	- 0.8	+0.2	+1.2	V	【Note 7-5】

Cautions when you turn on or off the power supply

Turn on or off the power supply with simultaneously or the following sequence.

The input signal of “MOD” Terminals(Pin No.11) must be low voltage when turning on the power supply, and it is held until more than double vertical periods after DATA is turned on completely. After then, it must be held high voltage until turning off the power supply.(Connect Pin No.11 terminals to the same signal.)

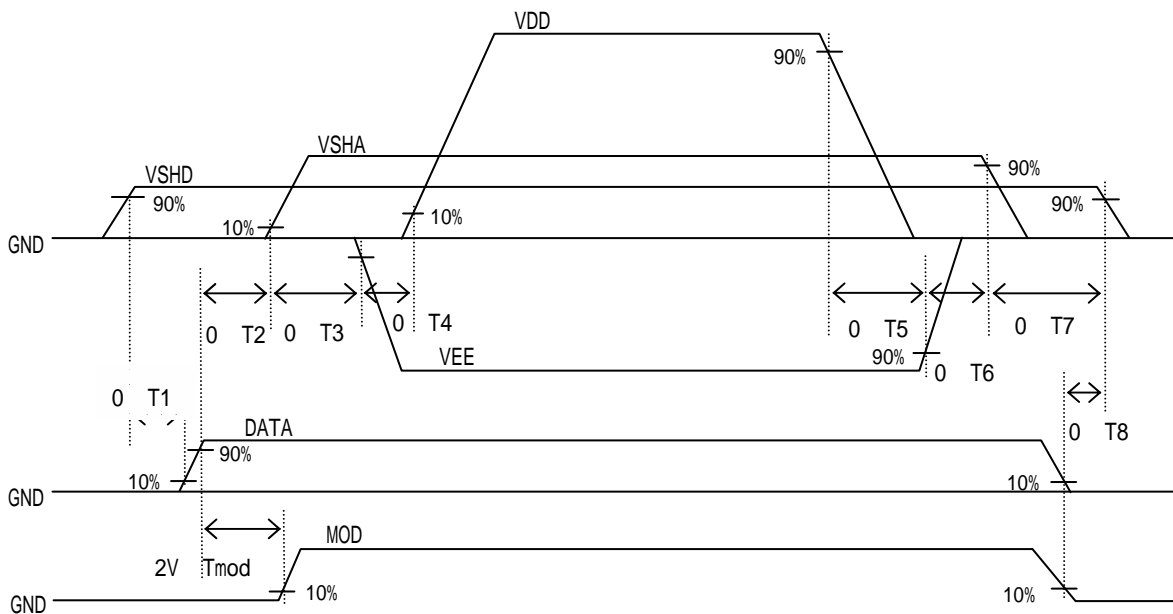

[查询LQ035Q7DK-SPI供应商](#)

BR,LP,PS,REV,R0 ~ R5,G0 ~ G5 and B0 ~ B5 terminals are applied.

【Note 7-2】 DCLK,SPL,SPR,LBR,LP,REV,R0 ~ R5,G0 ~ G5 and B0 ~ B5 terminals are applied.

【Note 7-3】 PS terminal is applied.

【Note 7-4】 MOD,CLS,SPS and U/L terminals are applied.

【Note 7-5】 VCOMAC should be alternated on VCOMDC every 1 horizontal period and 1 vertical period.

VCOMDC bias is adjusted so as to minimize flicker or maximum contrast every each module .

B) Back light driving section

Table 7

Ta=25

Parameter	Symbol	MIN	TYP	MAX	Units	Remarks terminal
LED voltage	VL	-	21.6	25.2	V	
LED current	IL	-	15	20	mA	
Power consumption	WL	-	0.324	-	W	【Note 7-6】

【Note 7-6】 Calculated reference value(IL × VL)

[查询“LQ0350ZDH01”供应商](#)

2) Timing Characteristics of input signals

Table 8 AC Characteristics (1)

(VSHA=+5V, VSHD=+3.3V, Ta=25)

Parameter	Symbol	Min.	Typ.	Max.	Unit	Remark	
Clock frequency of source driver	fCK	4.5	-	6.8	MHz		
Source driver	Rising time of clock	Tcr	-	-	20	ns	DCLK
	Falling time of clock	Tcf	-	-	20	ns	
	Pulse width (High level)	Tcwh	40	-	-	ns	
	Pulse width (Low level)	Tcwl	40	-	-	ns	
	Frequency of start pulse	fsp	16.5	-	28	kHz	SPL,SPR
	Setup time of start pulse	Tsusp	15	-	-	ns	
	Hold time of start pulse	Thsp	10	-	-	ns	
	Pulse width of start pulse	Twsp	-	-	1.5/fCK	ns	【Note 7-7】
	Setup time of latch pulse	Tsulp	20	-	-	ns	LP
	Hold time of latch pulse	Thlp	20	-	-	ns	
	Pulse width of latch pulse	Twlp	60	-	-	ns	
	Setup time of PS	Tsups	0	-	-	μs	PS
	Setup time of PS	Tsulps	1	-	-	μs	
	Hold time of PS	Thps	0	-	-	μs	
Hold time of PS	Thlps	30	-	-	ns		
Set up time of data	Tsud	15	-	-	ns	R0 ~ R5,G0 ~ G5	
Hold time of data	Thd	10	-	-	ns	,B0 ~ B5	
Gate driver	Clock frequency	fcls	16.5	-	28	kHz	CLS
	Pulse width of clock(Low)	Twlcls	5	-	(1/fcls)-30	μs	
	Pulse width of clock(High)	Twhcls	30	-	-	μs	
	Rising time of clock	Trcls	-	-	100	ns	
	Falling time of clock	Tfcls	-	-	100	ns	
	Setup time of clock	Tsucts	3	-	-	μs	
	Hold time of clock	Thcls	0	-	-	μs	SPS
	Frequency of start pulse	fsps	58	-	86	Hz	
	Setup time of start pulse	Tsusps	100	-	-	ns	
	Hold time of start pulse	Thsps	300	-	-	ns	
	Rising time of start pulse	Trsps	-	-	100	ns	
Falling time of start pulse	Tfsps	-	-	100	ns		
Vcom	Setup time of Vcom	Tsuvcom	0	-	-	μs	Vcom
	Hold time of Vcom	Thvcom	1	-	-	μs	

【Note 7-7】 There must be only one up-edge of DCLK (includes Tsusp and Thsp time) in the period of SPL="Hi".

[查询"LQ035Q7DH01"供应商](#)

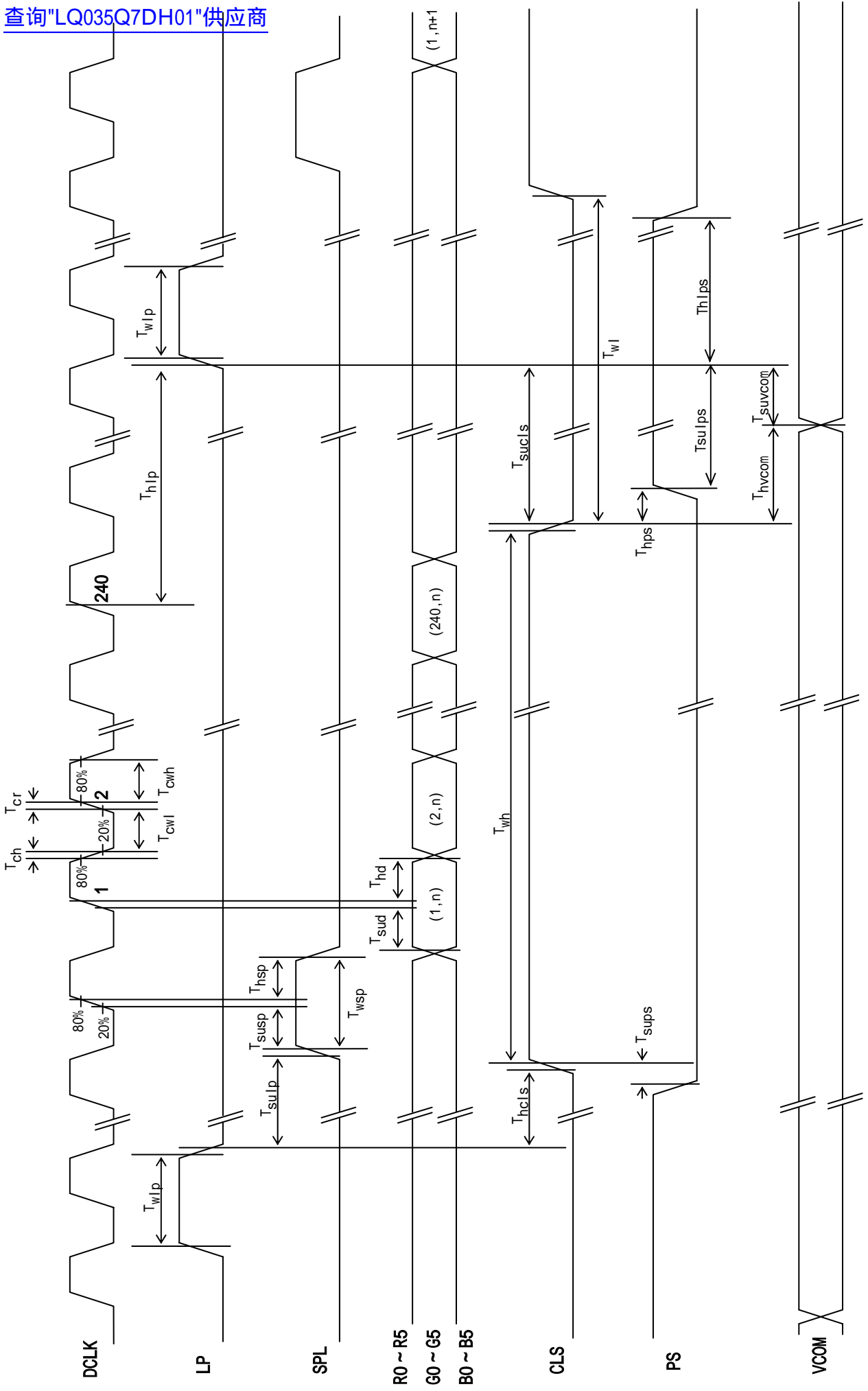

Fig (a) Horizontal timing chart

[查询"LQ035Q7DH01"供应商](#)

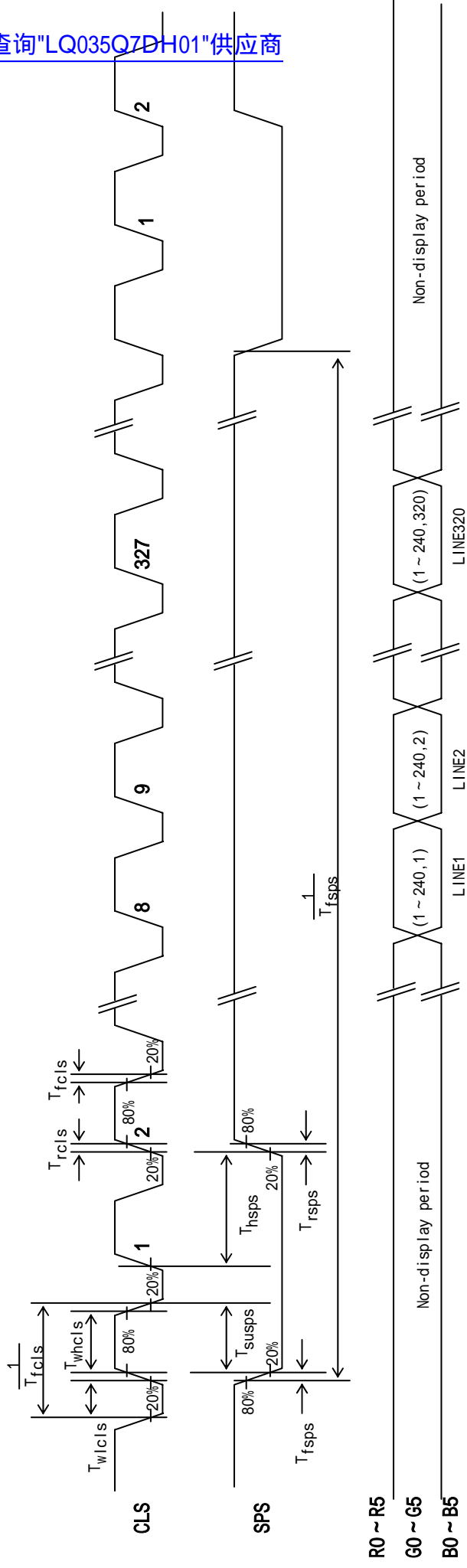

Fig.(b) Vertical timing chart

7-3) [查询"LC035Q7DH01"供应商](#)

Measurement condition : SPS=60Hz,CLS=15.73kHz,SPL=15.73kHz,DCLK=6.3MHz

The term of PS="Lo" in one horizontal period ... 37 μ sec(234DCLK)

Ta=25

Table 9

when normal scan mode

Parameter		Sym	Conditions	MIN	TYP	MAX	Unit	Remarks
Source current	Analog	ISHA	VSHA=+5.0V	-	3.0	6.0	mA	【Note 7-8】
	Digital	ISHD	VSHD=+3.3V	-	1.5	3.0	mA	【Note 7-8】
Gate current	High	IDD	VDD=+15.0V	-	0.05	0.10	mA	【Note 7-9】
	Low	IEE	VEE=-10.0V	-	- 0.05	- 0.10	mA	【Note 7-9】

【Note 7-8】 Vertical stripe pattern alternating 21 gray scale (GS21) with 42 gray scale (GS42) every 1 dot.

【Note 7-9】 64-Gray-bar vertical pattern (GS0 ~ GS63 for horizontal way)

(8) Input Signals, Basic Display Color and Gray Scale of Each Color

Table 10

Colors & Gray scale	Data signal																		
	Gray Scale	R0	R1	R2	R3	R4	R5	G0	G1	G2	G3	G4	G5	B0	B1	B2	B3	B4	B5
Basic color	Black	-	0	0	0	0	0	0	0	0	0	0	0	0	0	0	0	0	0
	Blue	-	0	0	0	0	0	0	0	0	0	0	0	1	1	1	1	1	1
	Green	-	0	0	0	0	0	0	1	1	1	1	1	1	0	0	0	0	0
	Cyan	-	0	0	0	0	0	0	1	1	1	1	1	1	1	1	1	1	1
	Red	-	1	1	1	1	1	1	0	0	0	0	0	0	0	0	0	0	0
	Magenta	-	1	1	1	1	1	1	0	0	0	0	0	0	1	1	1	1	1
	Yellow	-	1	1	1	1	1	1	1	1	1	1	1	1	0	0	0	0	0
	White	-	1	1	1	1	1	1	1	1	1	1	1	1	1	1	1	1	1
Gray Scale of red	Black	GS0	0	0	0	0	0	0	0	0	0	0	0	0	0	0	0	0	0
	↑	GS1	1	0	0	0	0	0	0	0	0	0	0	0	0	0	0	0	0
	Darker	GS2	0	1	0	0	0	0	0	0	0	0	0	0	0	0	0	0	0
	↑	↓				↓				↓							↓		
	↓	↓				↓				↓							↓		
	Brighter	GS61	1	0	1	1	1	1	0	0	0	0	0	0	0	0	0	0	0
	↓	GS62	0	1	1	1	1	1	0	0	0	0	0	0	0	0	0	0	0
	Red	GS63	1	1	1	1	1	1	0	0	0	0	0	0	0	0	0	0	0
Gray Scale of green	Black	GS0	0	0	0	0	0	0	0	0	0	0	0	0	0	0	0	0	0
	↑	GS1	0	0	0	0	0	0	1	0	0	0	0	0	0	0	0	0	0
	Darker	GS2	0	0	0	0	0	0	0	1	0	0	0	0	0	0	0	0	0
	↑	↓				↓					↓						↓		
	↓	↓				↓					↓						↓		
	Brighter	GS61	0	0	0	0	0	0	1	0	1	1	1	1	0	0	0	0	0
	↓	GS62	0	0	0	0	0	0	0	1	1	1	1	1	0	0	0	0	0
	Green	GS63	0	0	0	0	0	0	1	1	1	1	1	1	0	0	0	0	0
Gray Scale of blue	Black	GS0	0	0	0	0	0	0	0	0	0	0	0	0	0	0	0	0	0
	↑	GS1	0	0	0	0	0	0	0	0	0	0	0	1	0	0	0	0	0
	Darker	GS2	0	0	0	0	0	0	0	0	0	0	0	0	1	0	0	0	0
	↑	↓				↓					↓						↓		
	↓	↓				↓					↓						↓		
	Brighter	GS61	0	0	0	0	0	0	0	0	0	0	0	0	1	0	1	1	1
	↓	GS62	0	0	0	0	0	0	0	0	0	0	0	0	0	1	1	1	1
	Bleu	GS63	0	0	0	0	0	0	0	0	0	0	0	0	1	1	1	1	1

0 :Low level voltage 1 :High level voltage

Each basic color can be displayed in 64 gray scales from 6 bit data signals. According to the combination of total 18 bit data signals, the 262,144-color display can be achieved on the screen.

(9)Optical characteristics [查询"LQ035Q7DH01"供应商](#)

9-1)Not driving the Back light condition

Table 11

(VSHA=+5V, VSHD=+3.3V, VDD=+15V, VEE=-10V ,Ta=25)

Parameter	Symbol	Condition	Min	Typ	Max	Unit	Remarks
Viewing angle range	$\theta_{21,22}$	CR \geq 2	35	50	-	degree	[Note 9-1,2]
	θ_{11}		35	50	-	degree	
	θ_{12}		35	50	-	degree	
Contrast ratio	CRmax	$\theta = 0^\circ$	3	4	-		[Note 9-2,4]
Response time	Rise	τ_r	-	30	60	ms	[Note 9-3]
	Fall		τ_d	-	50	100	
White chromaticity	x	$\theta = 0^\circ$	0.27	0.32	0.37		[Note 9-4]
	y		0.30	0.35	0.40		
Reflection ratio	R	$\theta = 0^\circ$	2.5	4	-	%	[Note 9-5]

* The measuring method of the optical characteristics is shown by the following figure.

* A measurement device is Otsuka luminance meter LCD5000.(With the diffusion reflection unit.)

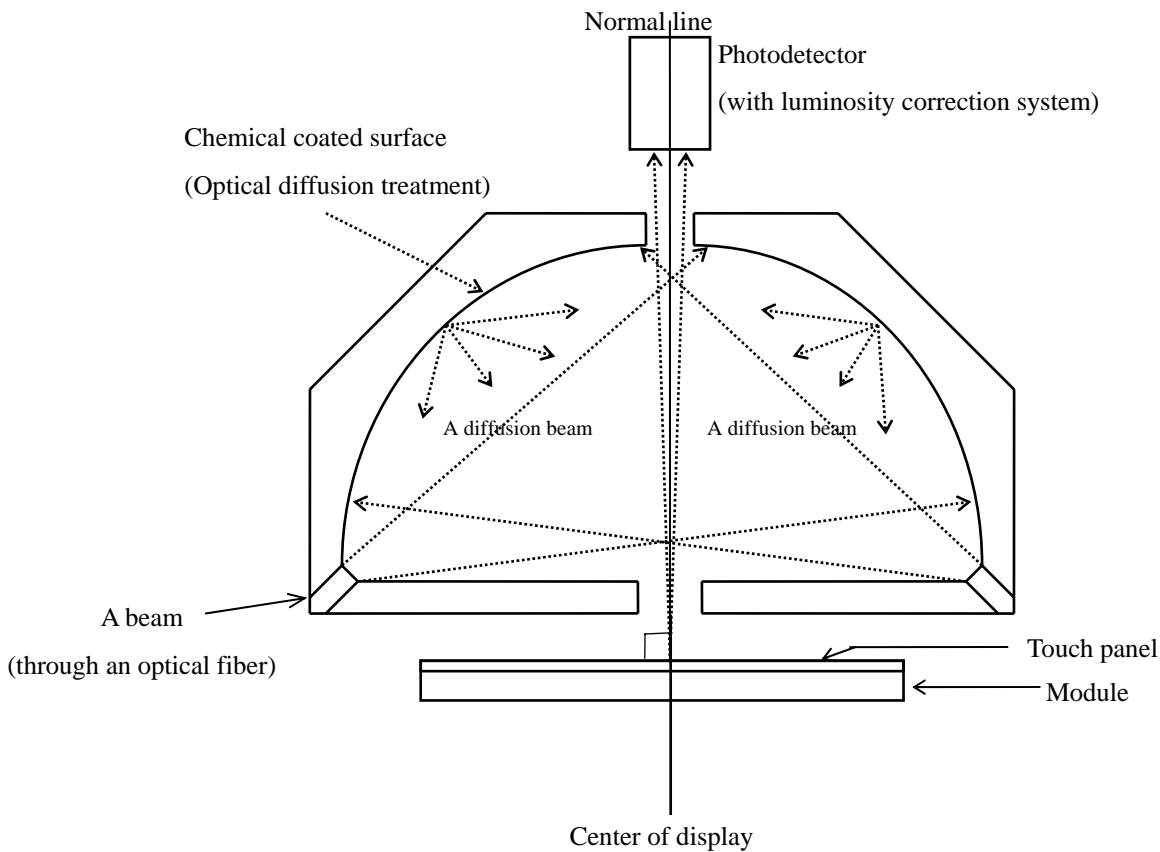

Measuring method (a) for optical characteristics

[查询"LQ035Q7DH01"供应商](#)

9-2)Driving the Back light condition

Table 12

(VSHA=+5V, VSHD=+3.3V, VDD=+15V, VEE=-10V, Ta=25)

Parameter	Symbol	Condition	Min	Typ	Max	Unit	Remarks	
Viewing angle range	θ1,2	CR≥2	30	40	-	degree	[Note 9-1,2,6]	
	θ11		40	50	-	degree		
	θ12		30	40	-	degree		
Contrast ratio	Crmax	θ = 0°	40	70	-		[Note 9-2]	
Response time	Rise		τ r	-	30	60	ms	[Note 9-3]
	Fall		τ d	-	50	100	ms	
White chromaticity	x		0.25	0.30	0.35			
	y	0.28	0.33	0.38				
Brightness	Y	θ = 0°	75	100	-	cd/m2	IL=18mA	
LED life time	LL	IL=15mA	-	10000	-	hour	[Note 9-7]	

* The measuring method of the optical characteristics is shown by the following figure.

* A measurement device is TOPCON luminance meter BM-5(A).(Viewing cone 1)

Photodetector(including luminosity factor)

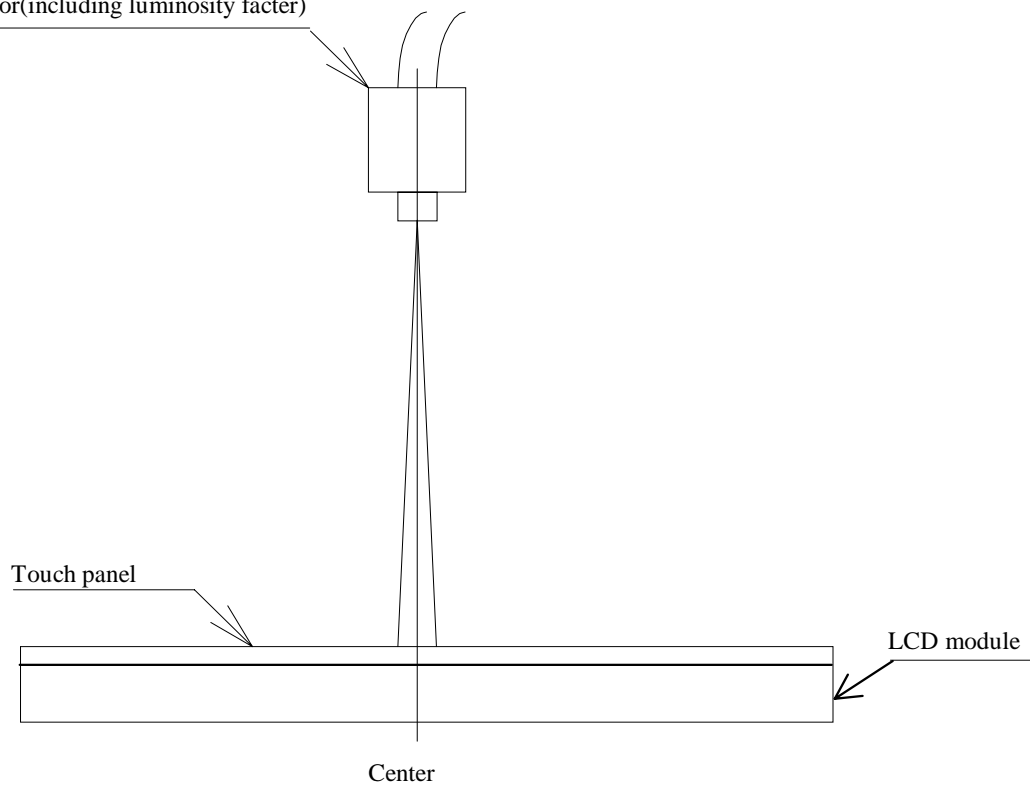

Measuring method (c) for optical characteristics

[查询"LQ035Q7DH01"供应商](#)

[Note 9-1] Viewing angle range is defined as follows.

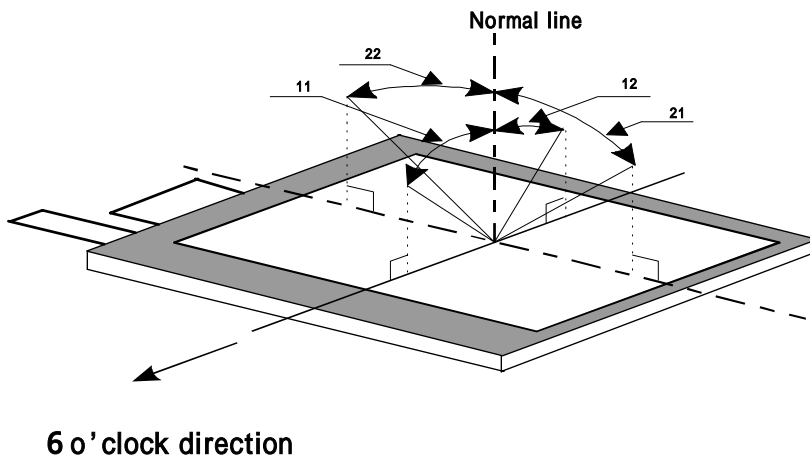

Definition for viewing angle

[Note 9-2] Definition of contrast ratio:

The contrast ratio is defined as follows:

$$\text{Contrast ratio(CR)} = \frac{\text{Photodetector output with all pixels white(GS63)}}{\text{Photodetector output with all pixels black(GS0)}} \times \text{VCOMAC} = 5.0\text{Vp-p}$$

[Note 9-3] Definition of response time:

The response time is defined as the following figure and shall be measured by switching the input signal for "black" and "white".

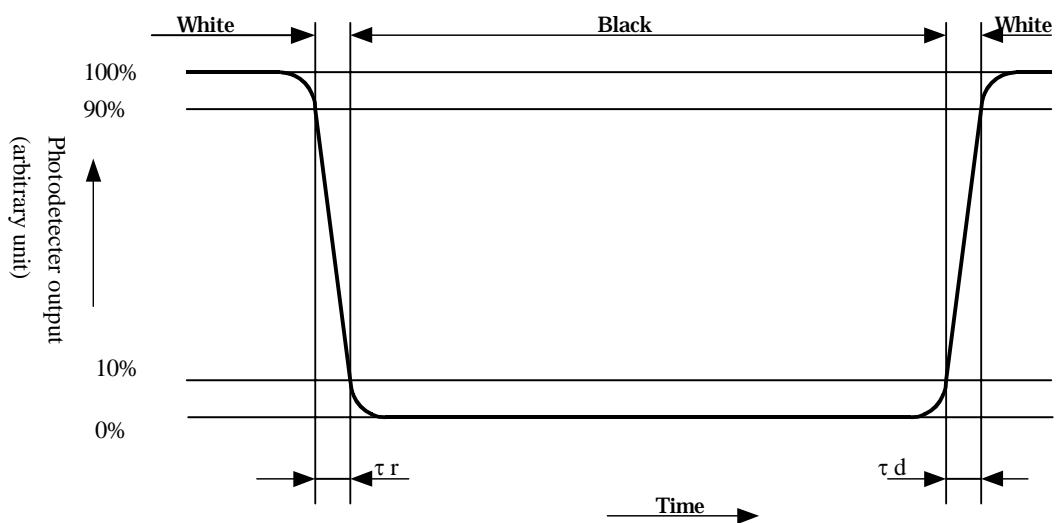

[Note 9-4] Measurement device is Minolta CM-2002.

[Note 9-5] Definition of reflection ratio

$$\text{Reflection ratio} = \frac{\text{Light detected level of the reflection by the LCD module}}{\text{Light detected level of the reflection by the standard white board}}$$

[Note 9-6] A measurement device is ELDIM EZContrast

[Note 9-7] This is the reference value. The White-LED life time is defined as a time when brightness not to become under 50% of the original value(at Ta=25)

(10) Touch panel characteristics

Table 13

Parameter	Min.	Typ.	Max.	Unit	Remark
Input voltage	-	5.0	7.0	V	
Resistor between terminals(XL-XR)	200	-	640		Provisional specification
Resistor between terminals(YU-YD)	150	-	550		
Line linearity(X direction)	-	-	1.5	%	
Line linearity(Y direction)	-	-	1.5	%	
Insulation resistance	20	-	-	M	at DC25V
Minimum tension for detecting	-	-	0.79	N	

(11) Display quality

The display quality of the color TFT-LCD module shall be in compliance with the Incoming Inspection Standards for TFT-LCD..

(12) Mechanical characteristics

12-1) External appearance

See Fig. 1

12-2) FPC (for LCD panel) characteristics

(1) Specific connector

FH12A-50S-0.5SH(HIROSE)

(2) Bending endurance of the bending slits portion

No line of the FPC is broken for the bending test (Bending radius=0.6mm and angle=90°) in 30 cycles.

12-3) Design guidance for touchpanel(T/P)

12-3-1) Example of housing design

(1) If a consumer will put a palm on housing in normal usage, care should be taken as follows.

(2) Keep the gap, for example 0.3 to 0.7mm, between bezel edge and T/P surface.

The reason is to avoid the bezel edge from contacting T/P surface that may cause a "short" with bottom layer(See Fig.2)

(3) Insertion of a cushion material is recommended.

(4) The cushion material should be limited just on the busbar insulation paste area.

If it is over the transparent insulation paste area, a "short" may be occurred.

(5) There is one where a resistance film is left in the T/P part of the end of the pole.

Design to keep insulation from the perimeter to prevent from mis-operation and so on.

12.3.2 Mounting on display and housing bezel

- (1) In all cases, the T/P should be supported from the backside of the Plastic.
- (2) Do not use an adhesive-tape to bond it on the front of T/P and hang it to the housing bezel.
- (3) Never expand the T/P top layer (PET-film) like a balloon by internal air pressure.

The life of the T/P will be extremely short.

- (4) Top layer, PET, dimension is changing with environmental temperature and humidity.

Avoid a stress from housing bezel to top layer, because it may cause "waving".

- (5) The input to the Touchpanel sometimes distorts touch panel itself.

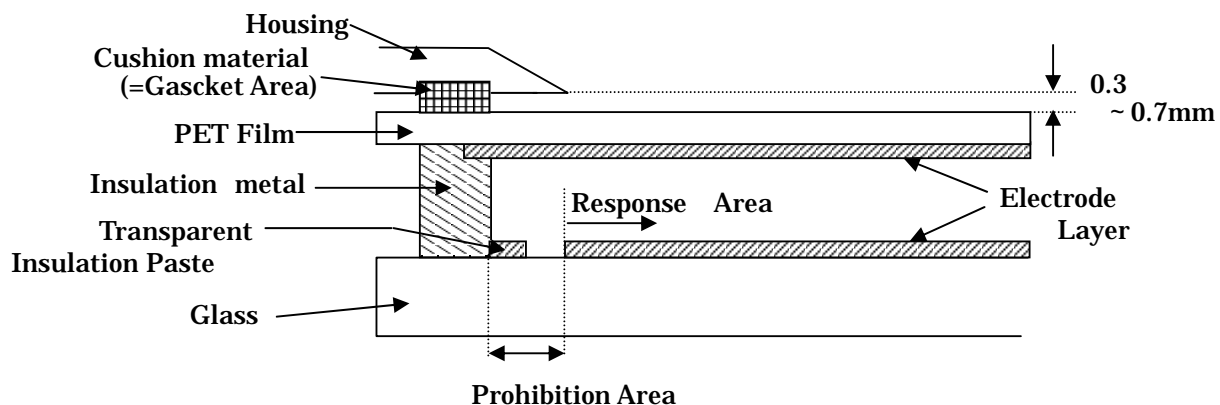

Fig.2

(13) [查询"LC035QZDH01"供应商](#)
Handling Precautions

13-1) Insertion and taking out of FPCs

Be sure insert and take out of the FPC into the connector of the set after turning off the power supply on the set side.

13-2) Handling of FPCs

The FPC for LCD panel shall be bent only slit portion. The bending slit shall be bent uniformly on the whole slit portion with bending radius larger than 0.6mm ,and only inner side (back side of the module). Don't bend it outer side (display surface side).

Don't give the FPCs too large force, for example, hanging the module with holding FPC.

13-3) Installation of the module

On mounting the module, be sure to fix the module on the same plane. Taking care not to warp or twist the module.

13-4)Precaution when mounting

- (1) If water droplets and oil attaches to it for a long time, discoloration and staining occurs. Wipe them off immediately.
- (2) Glass is used for the TFT-LCD panel. If it is dropped or bumped against a hard object, it may be broken. Handle it with sufficient care.
- (3)As the CMOS IC is used in this module, pay attention to static electricity when handling it. Take a measure for grounding on the human body.

13-5)Others

- (1) The liquid-crystal is deteriorated by ultraviolet rays. Do not leave it in direct sunlight and strong ultraviolet rays for many hours.
- (2) If it is kept at a temperature below the rated storage temperature, it becomes coagulated and the panel may be broken. Also, if it is kept at a temperature above the rated storage temperature, it becomes isotropic liquid and does not return to its original state. Therefore, it is desirable to keep it at room temperature as much as possible.
- (3) If the LCD breaks, don't put internal liquid crystal into the mouth. When the liquid crystal sticks to the hands, feet and clothes, wash it out immediately.
- (4) Wipe off water drop or finger grease immediately. Long contact with water may cause discoloration or spots.
- (5) Observe general precautions for all electronic components.
- (6) VCOM must be adjusted on condition of your final product. No adjustment causes the deterioration for display quality.
- (7) Static image should not be displayed more than 5 minutes in order to prevent from occurrence of residual image.
- (8) If local pressure joins T/P surface for a long time, it will become the cause of generating of Newton's ring.

【Note】 [查询LQ035Q7DH01#供应商](#) T_p = Panel temperature

【Check items】

(a) Test No.1 ~ 9

In the standard condition, there shall be no practical problems that may affect the display function.

(b) Test No.10 ~ No.11

The measurements after the tests are satisfied (10)-Table 13 (Touch panel characteristics)

(15) Others

15-1) Indication of lot number

The lot number is shown on a label. Attached location is shown in Fig.1 (Outline Dimensions).

Indicated contents of the label

LQ035Q7DH01

model No.

lot No.

15-2) Used Regulation of Chemical Substances Breaking Ozone Stratum

Substances with the object of regulating : CFCS, Carbon tetrachloride, Halon

1,1,1-Trichloro ethane (Methyl chloroform)

- (a) This LCD module, Constructed part and Parts don't contain the above substances.
- (b) This LCD module, Constructed part and Parts don't contain the above substances in processes of manufacture.

15-3) If some problems arise about mentioned items in this document and other items, the user of the TFT-LCD module and Sharp will cooperate and make efforts to solve the problems with mutual respect and good will.

16) Forwarding form (see Fig. 3 Package Form)

- a) Piling number of cartons : Max 20
- b) Package quality in one cartons : 50pcs
- c) Carton size : 562mm x 311mm x 75mm
- d) Total mass of 1 carton filled with full modules : 3550g

Conditions for storage.

Environment

- (1) Temperature : 0 ~ 40
- (2) Humidity : 60%RH or less (at 40)
No dew condensation at low temperature and high humidity.
- (3) Atmosphere : Harmful gas, such as acid or alkali which bites electronic components and/or wires, must not be detected.
- (4) Period : about 3 months
- (5) Opening of the package : In order to prevent the LCD module from breakdown by electrostatic charges, please control the room humidity over 50%RH and open the package taking sufficient countermeasures against electrostatic charges, such as earth, etc

[查询"LQ035Q7DH01"供应商](#)

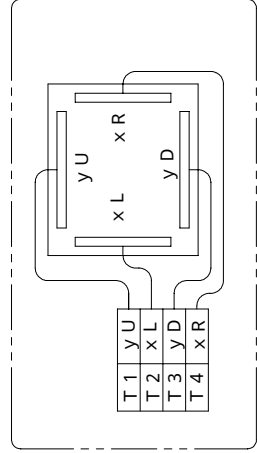
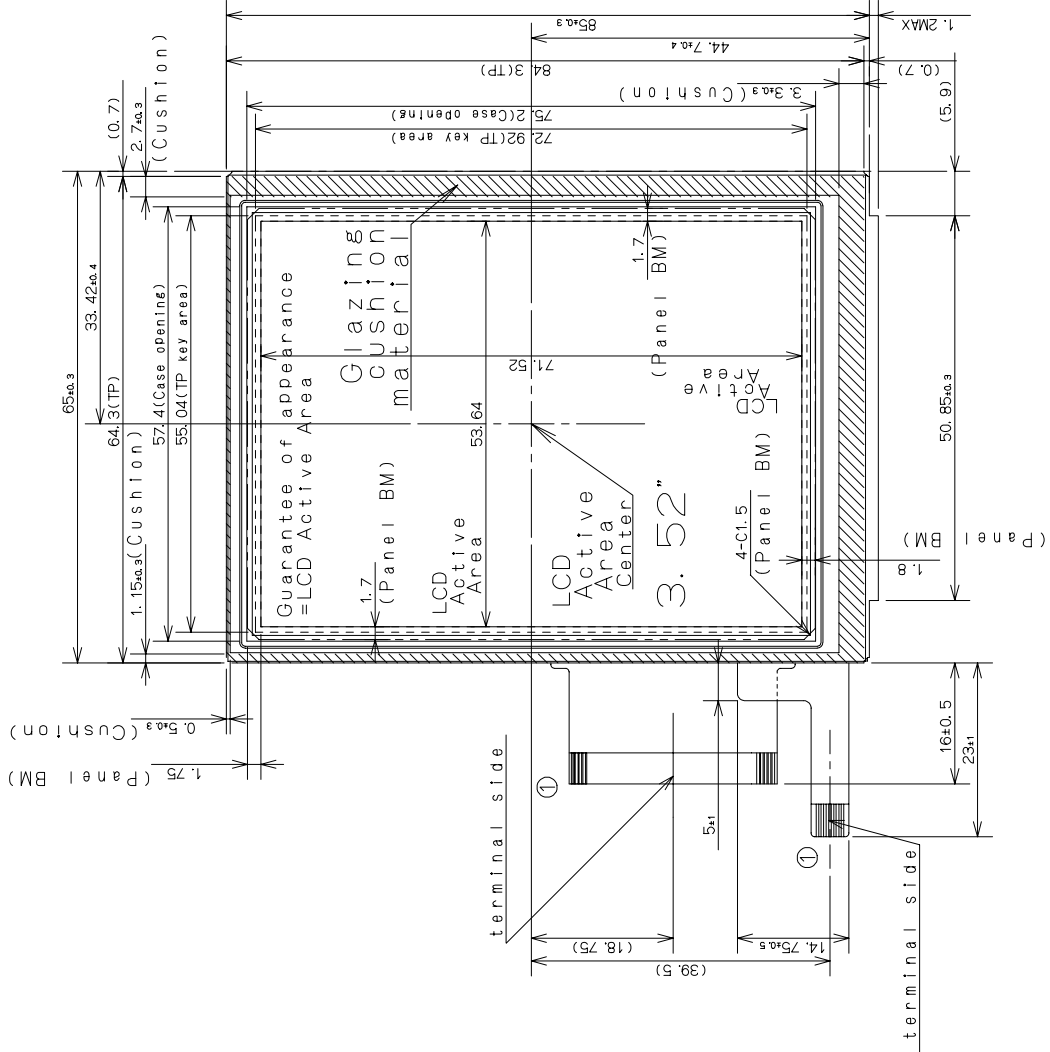
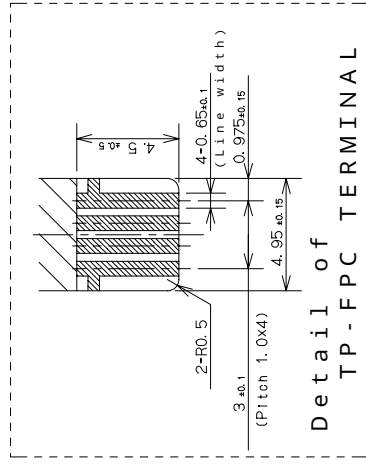
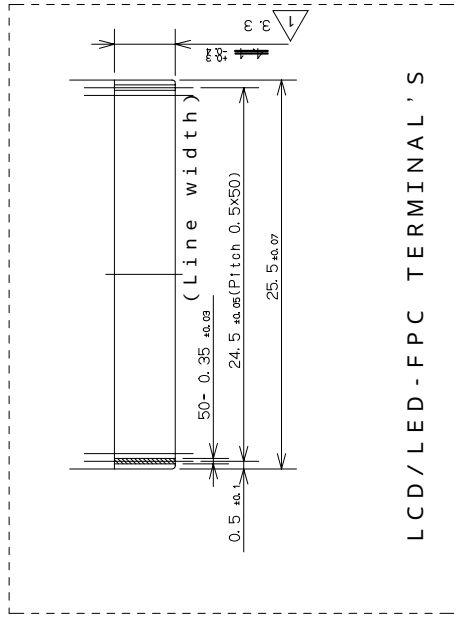

[查询"LQ035Q7DH01"供应商](#)

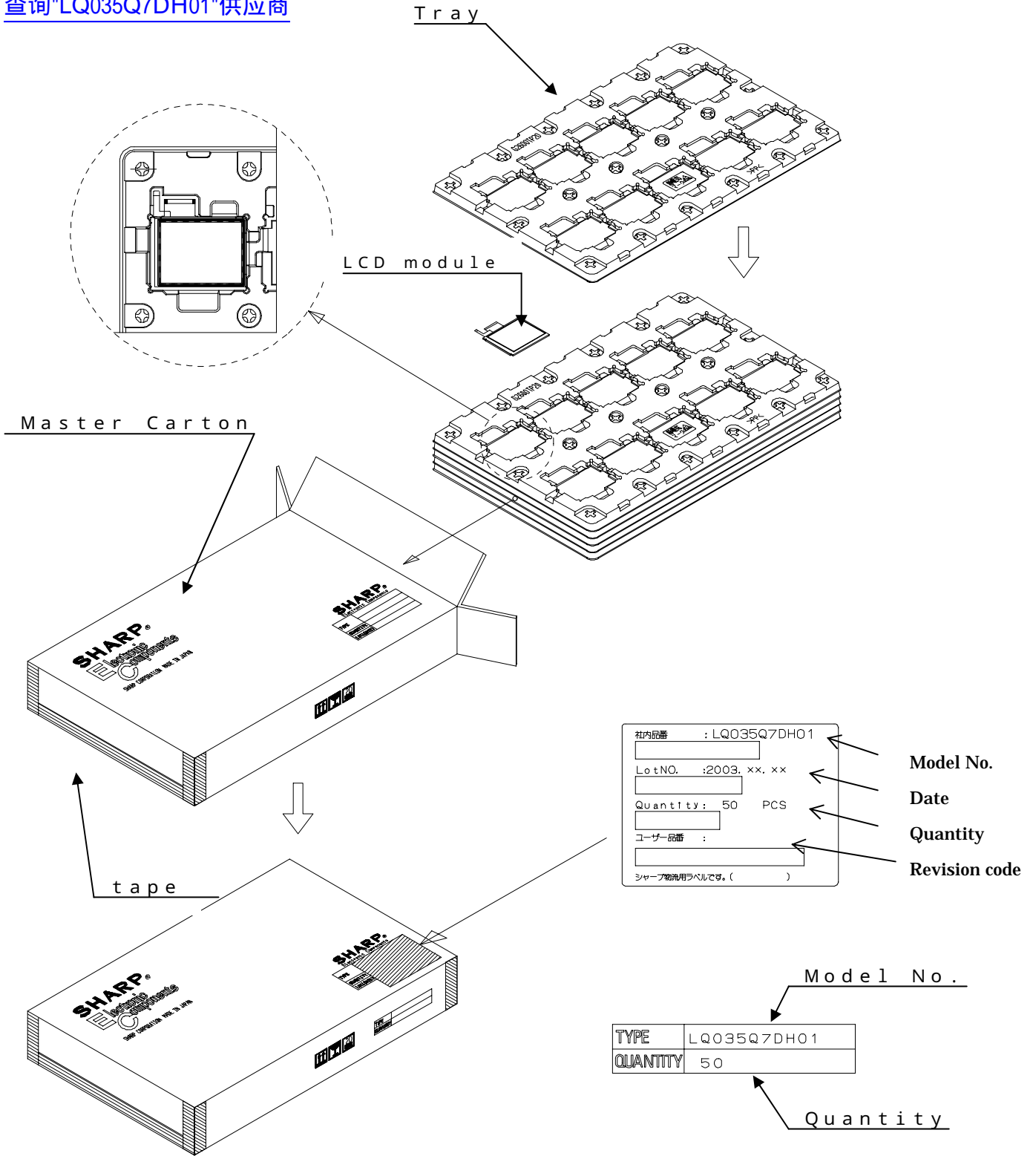

Fig.3 Forwarding Form