

2.5mm Pitch Connector for Discrete Wire Connection (Product Compliant with UL/CSA Standard)

查询"DE1B-4S-2.5R"供应商
DF1B Series

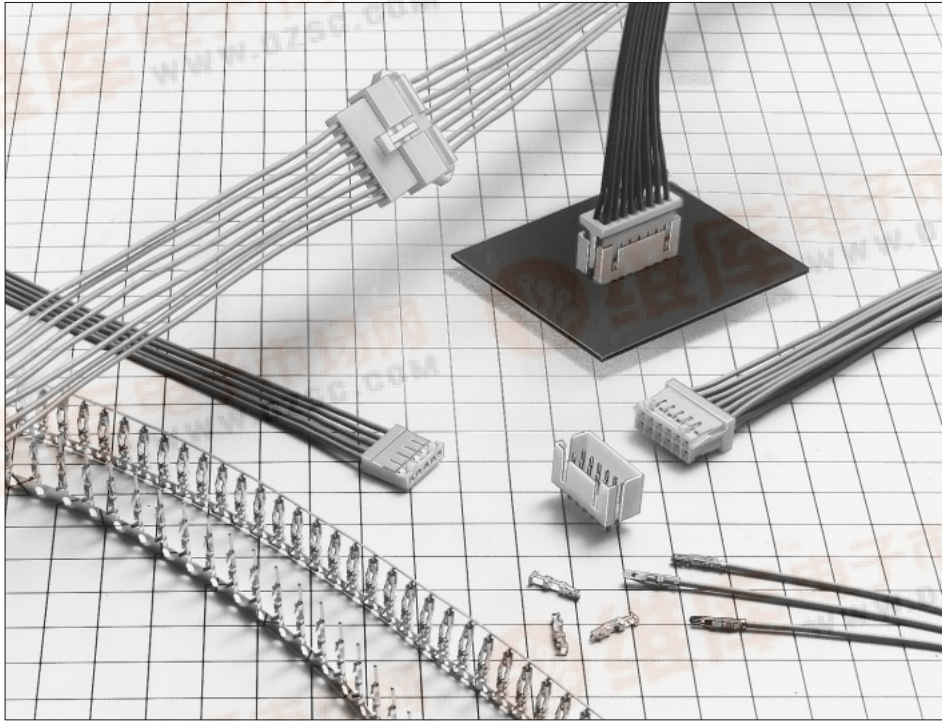

■Features

1. New Insulation Displacement and Crimping Ideas

This connector is a new type to insert the ID contacts in the case. Using this method, the following merits can be gained.

- ① By using the ID contact and crimping contact together, different current capacity cables can be mixed in one case.
- ② After connection, the contact can be replaced in excellent maintainability.
- ③ Because the insulation displacement area is protected by the case, high reliability can be assured.
- ④ Since the insulation displacement process can be performed only by replacing the applicator of the existing crimping machine, no expensive machine for insulation displacement is required.

2. Potting Header Available

The high profile header is also available, corresponding to the board potting process (sealed with resin) as waterproof measures.

3. Broad Variations

The single row and double row contacts are aligned for "Board to Cable" and "In-line" series, respectively, while standard tin and gold plating products are available.

(Refer to the applicable combination pattern on next page.)

■Applications

Business equipment, particularly including the copy machine and printer

Cables with different current capacities can be mixed in one case

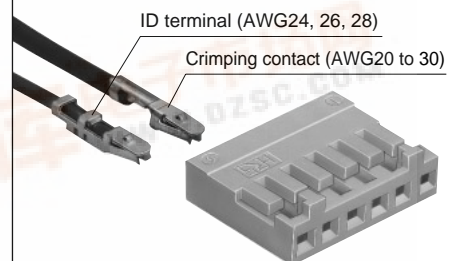

Figure 1

Potting status

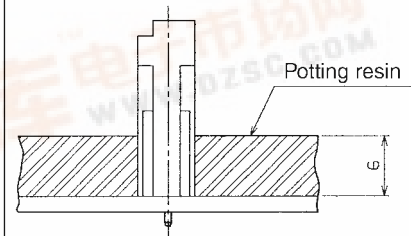

Figure 2

◆ Applicable Combination

● Single Row Type

[查询"DF1B-4S-2.5R"供应商](#)

Socket (Cable Side)

DF1B-*S-2.5R

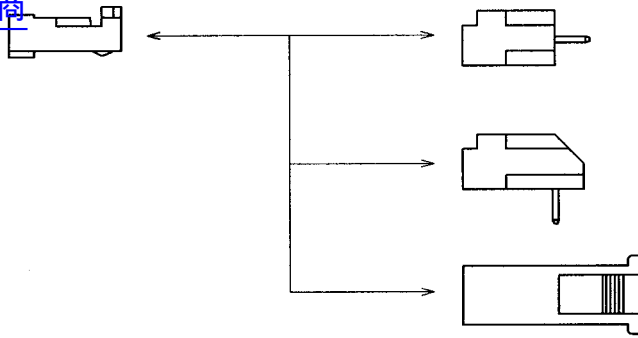

Straight Through hole Type

Pin header

DF1B-*P-2.5DSA

Right angle Through hole Type

Pin header

DF1B-*P-2.5DS

Panel Mount Type

In-line plug (Cable side)

DF1BA-*EP-2.5RC

● Double Row Type

Socket (Cable Side)

DF1B-*DS-2.5RC

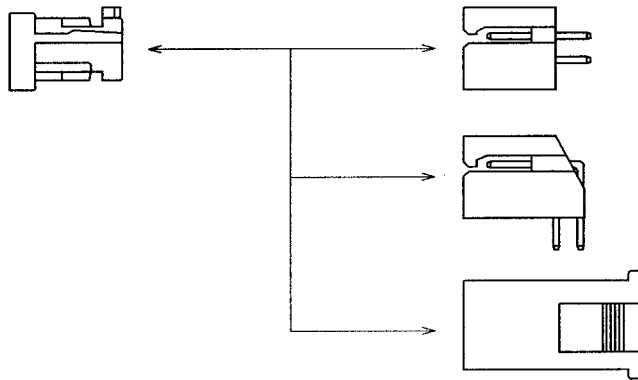

Straight Through hole Type

Pin header

DF1B-*DP-2.5DSA

Right angle Through hole Type

Pin header

DF1B-*DP-2.5DS

Panel Mount Type

In-line plug (Cable side)

DF1BA-*DEP-2.5RC

In-line Connection Product (Cable to Cable Connection) : Full Lock Type

● Single Row Type

Socket (Cable Side)

DF1B-*ES-2.5RC



In-line plug (Cable side)

DF1B-*EP-2.5RC

● Double Row Type

Socket (Cable Side)

DF1B-*DES-2.5RC

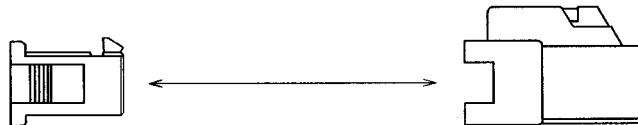

In-line plug (Cable side)

DF1B-*DEP-2.5RC

■Product Specifications

Rating	Current rating (Note1)	Cable Size	AWG 20 to 24 : 3A AWG 26 : 2A AWG 28 : 1A AWG 30 : 0.5A	Operating Temperature Range	-35 to +85°C (Note2)
	Voltage rating		250V AC	Operating Moisture Range	40 to 80%
				Storage Temperature Range	-10 to +60°C (Note3)
				Storage Moisture Range	40 to 70% (Note3)

UL-CSA Safety Standard Standardized Value			
Rating	Current rating (Note1)	Cable Size	AWG 20 to 22: 3A AWG 24 to 28: 1A AWG 30 : 0.5A
	Voltage rating		30V AC

■UL CSA Safety File No.

UL : E52653
CSA : LR95109

Item	Specification	Condition
1. Insulation Resistance	1000M ohms Min	500V DC
2. Withstanding voltage	No flashover or insulation breakdown.	650V AC/1 minute
3. Contact Resistance	30m ohms Max	100mA
4. Inserter/Extraction Force	MIN0.44N (45gf), MAX4.4N(450gf)	Measure at the square steel pin of 0.635±0.002mm
5. Vibration	No electrical discontinuity of 1μs or more	Frequency: 10 to 55 Hz, single amplitude of 0.75 mm, 2 hours in each of the 3 directions.
6. Humidity (Steady state)	Contact resistance: 30m ohms max.Insulation resistance: 1000M ohms min.	96 hours at temperature of 40°C and humidity of 90% to 95%
7. Temperature Cycle	Contact resistance: 30m ohms max:Insulation resistance: 1000M ohms min.	(-55°C: 30 minutes → 15 to 35°C: 2 to 3 minutes 85°C: 30 minutes → 15 to 35°C: 2 to 3 minutes) 5 cycles
8. Operating Life	Contact resistance: 30m ohms max.	Tin plating : 30 cycles Gold plating : 50 cycles
9. Resistance to Soldering heat	No deformation of components affecting performance.	Flow: 250°C for 10 seconds
		Manual soldering: 300°C for 3 seconds

Note 1: Includes temperature rise caused by current flow.

Note 2: The term "storage" refers to products stored for long period of time prior to mounting and use. Operating Temperature Range and Humidity range covers non conducting condition of installed connectors in storage, shipment or during transportation.

■Material

Product	Part	Material	Finish	Remarks
Socket	Insulator	Polyamide	White	UL94V-0
ID Contact for Socket	Contact	Phosphor copper	Tin plated or gold plated	————
Crimping Contact for Socket	Contact	Phosphor copper	Tin plated or gold plated	————
Pin Header	Insulator	Polyamide	White	UL94V-0
	Contact	Brass	Tin plated or gold plated	————
In-line Plug	Insulator	Polyamide	White	UL94V-0
ID Contact for In-line Plug	Contact	Phosphor copper	Tin plated or gold plated	————
Crimping Contact for In-line Plug	Contact	Phosphor copper	Tin plated or gold plated	————

Note: The whisker method is implemented for tin plating.

■ Ordering Information

[查询"DF1B-4S-2.5R"供应商](#)

● Connector

DF1B - * S 2.5 RC

① ② ③ ④ ⑤

① Series Name : DF 1B	③ Connector Type	④ Contact Pitch: 2.5mm
② Number of Contacts Single Row : 2 to 16, 18, 20 Double Row : 4 to 30, 34, 40	S : Single row socket DS : Double row socket P : Single row pin header DP : Double row pin header ES : Single row in-line socket DES : Double row in-line socket EP : Single row in-line plug DEP : Double row in-line plug	⑤ Contact Type RC : ID/crimping socket (Note) DSA : Straight through hole DS : Right angle through hole Note: The single row socket DF1B-*S-2.5R only adds "R" to the tail, which has the same meaning as "RC".

● Socket ID Contact

DF1B - R 24 F A

① ② ③ ④

① 1. Connection Type R : ID	③ Packaging Type Blank : Bag F : Reel
② Applicable Cable Size 24 : AWG24 26 : AWG26 28 : AWG28	④ Plating Type Blank : Tin plated A : Gold plated

● Plug ID Contact

DF1B - 24 P R F B

① ② ③ ④ ⑤

① Applicable Cable Size 24 : AWG24 26 : AWG26 28 : AWG28	④ Packaging Type Blank : Bag F : Reel
② Connector Type P : Plug	⑤ Plating Type Blank : Tin plated A : Gold plated
③ Connection Type R : ID	

● Crimping Contact

DF1B - 2428 SCF A

① ② ③

① Applicable Cable Size 2022 : AWG20 to 22 2428 : AWG24 to 28 28 : AWG30	③ Plating Type Blank : Tin plating A : Gold plated B : Gold plated (Note)
② Packaging Type SCF : Socket Contact/Reel SC : Socket Contact/Bag PCF : Plug Contact/Reel PC : Plug Contact/Bag	Note: In case of the socket contact, "A" is attached to the tail of the product name. In case of the plug contact, "B" is attached thereto.

Single Row Socket

查询"DF1B-4S-2.5R"供应商

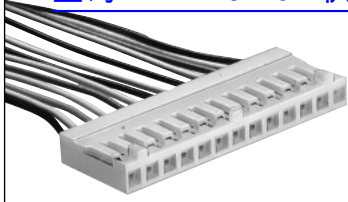
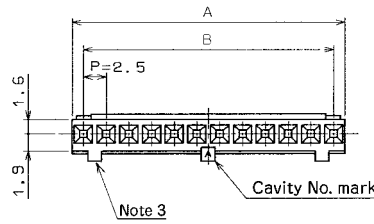
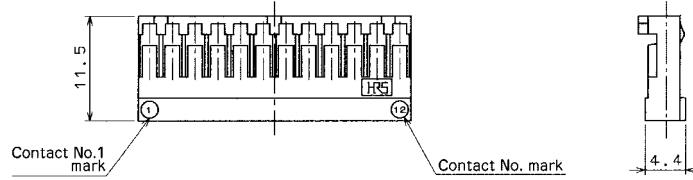

Photo: Contact Inserted



[Specific No.] -**,(**)
Blank :100 pcs. per bag



Unit: mm

Part Number	CL No.	Number of Contacts	A	B	Part Number	CL No.	Number of Contacts	A	B
DF1B- 2S-2.5R(**)	541-0200-6-**	2	5	2.5	DF1B-11S-2.5R(**)	541-0209-0-**	11	27.5	25
DF1B- 3S-2.5R(**)	541-0201-9-**	3	7.5	5	DF1B-12S-2.5R(**)	541-0210-0-**	12	30	27.5
DF1B- 4S-2.5R(**)	541-0202-1-**	4	10	7.5	DF1B-13S-2.5R(**)	541-0211-2-**	13	32.5	30
DF1B- 5S-2.5R(**)	541-0203-4-**	5	12.5	10	DF1B-14S-2.5R(**)	541-0212-5-**	14	35	32.5
DF1B- 6S-2.5R(**)	541-0204-7-**	6	15	12.5	DF1B-15S-2.5R(**)	541-0213-8-**	15	37.5	35
DF1B- 7S-2.5R(**)	541-0205-0-**	7	17.5	15	DF1B-16S-2.5R(**)	541-0214-0-**	16	40	37.5
DF1B- 8S-2.5R(**)	541-0206-2-**	8	20	17.5	DF1B-18S-2.5R(**)	541-0215-3-**	18	45	42.5
DF1B- 9S-2.5R(**)	541-0207-5-**	9	22.5	20	DF1B-20S-2.5R(**)	541-0216-6-**	20	50	47.5
DF1B-10S-2.5R(**)	541-0208-8-**	10	25	22.5					

Note1: The quantity at the specific No. "None" is delivered by the bag unit (100 pcs.). If needed, please order the product per bag.

Note2: The 2 contact connector contains the convex portion to prevent mis-insertion in the center at one point, which is different from the above figure. The 3 to 7 contacts connectors have the area at both ends.

Double Row Socket

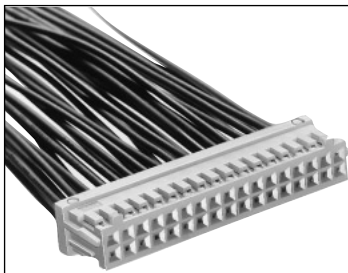
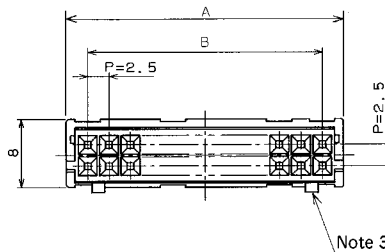
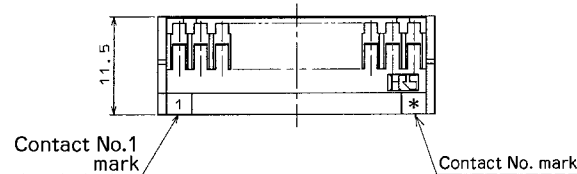

Photo: Contact Inserted.



[Specific No.] -**,(**)
Blank :100 pcs. per bag



Unit: mm

Part Number	CL No.	Number of Contacts	A	B	Part Number	CL No.	Number of Contacts	A	B
DF1B- 4DS-2.5RC(**)	541-0648-0-**	4	7.5	2.5	DF1B-22DS-2.5RC(**)	541-0606-0-**	22	30	25
DF1B- 6DS-2.5RC(**)	541-0649-3-**	6	10	5	DF1B-24DS-2.5RC(**)	541-0607-3-**	24	32.5	27.5
DF1B- 8DS-2.5RC(**)	541-0650-2-**	8	12.5	7.5	DF1B-26DS-2.5RC(**)	541-0608-6-**	26	35	30
DF1B-10DS-2.5RC(**)	541-0600-4-**	10	15	10	DF1B-28DS-2.5RC(**)	541-0609-9-**	28	37.5	32.5
DF1B-12DS-2.5RC(**)	541-0601-7-**	12	17.5	12.5	DF1B-30DS-2.5RC(**)	541-0610-8-**	30	40	35
DF1B-14DS-2.5RC(**)	541-0602-0-**	14	20	15	DF1B-34DS-2.5RC(**)	541-0612-3-**	34	45	40
DF1B-16DS-2.5RC(**)	541-0603-2-**	16	22.5	17.5	DF1B-36DS-2.5RC(**)	541-0613-6-**	36	47.5	42.5
DF1B-18DS-2.5RC(**)	541-0604-5-**	18	25	20	DF1B-40DS-2.5RC(**)	541-0615-1-**	40	52.5	47.5
DF1B-20DS-2.5RC(**)	541-0605-8-**	20	27.5	22.5					

Note1: The quantity at the specific No. "None" is delivered by the bag unit (100 pcs.). If needed, please order the product per bag.

Note2: The 4 contact connector contains the convex portion to prevent miss-insertion in the center at one point, which is different from the above figure.

Single Row Straight Pin Header

[查询"DF1B-4S-2.5R"供应商](#)

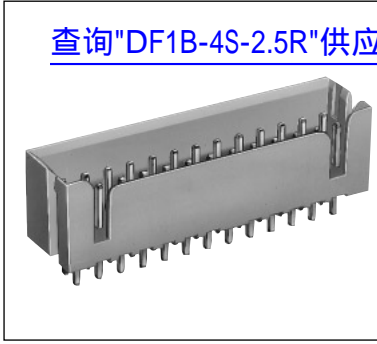

● Board Through-hole Diameter: $\phi 1.1^{+0.1}$

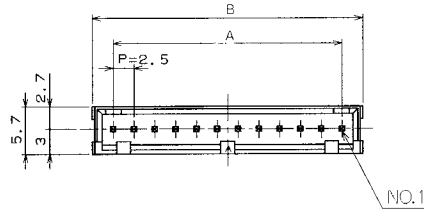

[Specific No.] -** , (**)
Blank: Tin plated
(01) : Gold plated

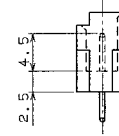
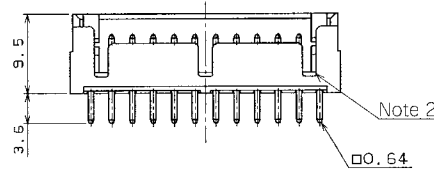

Unit: mm

Part Number	CL No.	Number of Contacts	A	B	Part Number	CL No.	Number of Contacts	A	B
DF1B- 2P-2.5DSA(**)	541-0225-7-**	2	2.5	7.5	DF1B-11P-2.5DSA(**)	541-0234-8-**	11	25	30
DF1B- 3P-2.5DSA(**)	541-0226-0-**	3	5	10	DF1B-12P-2.5DSA(**)	541-0235-0-**	12	27.5	32.5
DF1B- 4P-2.5DSA(**)	541-0227-2-**	4	7.5	12.5	DF1B-13P-2.5DSA(**)	541-0236-3-**	13	30	35
DF1B- 5P-2.5DSA(**)	541-0228-5-**	5	10	15	DF1B-14P-2.5DSA(**)	541-0237-6-**	14	32.5	37.5
DF1B- 6P-2.5DSA(**)	541-0229-8-**	6	12.5	17.5	DF1B-15P-2.5DSA(**)	541-0238-9-**	15	35	40
DF1B- 7P-2.5DSA(**)	541-0230-7-**	7	15	20	DF1B-16P-2.5DSA(**)	541-0239-1-**	16	37.5	42.5
DF1B- 8P-2.5DSA(**)	541-0231-0-**	8	17.5	22.5	DF1B-18P-2.5DSA(**)	541-0240-0-**	18	42.5	47.5
DF1B- 9P-2.5DSA(**)	541-0232-2-**	9	20	25	DF1B-20P-2.5DSA(**)	541-0241-3-**	20	47.5	52.5
DF1B-10P-2.5DSA(**)	541-0233-5-**	10	22.5	27.5					

Note 1. The quantity at the specific No. "None" is delivered by the bag unit (100 pcs.) If needed, please order the product per bag.

Note 2. The 2 and 3 contact connector contains the concave portion to prevent miss-insertion in the center at one point, which is different from the above figure. In addition, the 4 to 7 contact connectors have two concave portions at both ends.

Single Row Right Angle Pin Header



● Board Through-hole Diameter: $\phi 1.1^{+0.1}$

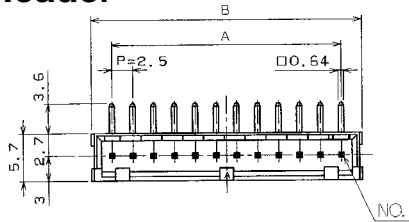

[Specific No.] -** , (**)
Blank: Tin plated
(01) : Gold plated

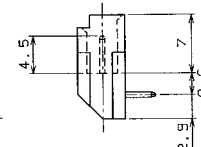
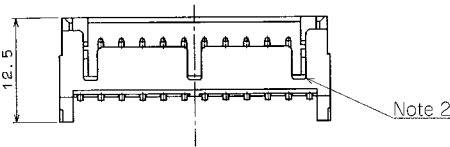

Unit: mm

Part Number	CL No.	Number of Contacts	A	B	Part Number	CL No.	Number of Contacts	A	B
DF1B- 2P-2.5DS(**)	541-0242-6-**	2	2.5	7.5	DF1B-11P-2.5DS(**)	541-0251-7-**	11	25	30
DF1B- 3P-2.5DS(**)	541-0243-9-**	3	5	10	DF1B-12P-2.5DS(**)	541-0252-0-**	12	27.5	32.5
DF1B- 4P-2.5DS(**)	541-0244-1-**	4	7.5	12.5	DF1B-13P-2.5DS(**)	541-0253-2-**	13	30	35
DF1B- 5P-2.5DS(**)	541-0245-4-**	5	10	15	DF1B-14P-2.5DS(**)	541-0254-5-**	14	32.5	37.5
DF1B- 6P-2.5DS(**)	541-0246-7-**	6	12.5	17.5	DF1B-15P-2.5DS(**)	541-0255-8-**	15	35	40
DF1B- 7P-2.5DS(**)	541-0247-0-**	7	15	20	DF1B-16P-2.5DS(**)	541-0256-0-**	16	37.5	42.5
DF1B- 8P-2.5DS(**)	541-0248-2-**	8	17.5	22.5	DF1B-18P-2.5DS(**)	541-0257-3-**	18	42.5	47.5
DF1B- 9P-2.5DS(**)	541-0249-5-**	9	20	25	DF1B-20P-2.5DS(**)	541-0258-6-**	20	47.5	52.5
DF1B-10P-2.5DS(**)	541-0250-4-**	10	22.5	27.5					

Note 1. The quantity at the specific No. "None" is delivered by the bag unit (100 pcs.) If needed, please order the product per bag.

Note 2. The 4 and 6 contact connector contains the concave portion to prevent miss-insertion in the center at one point, which is different from the above figure.

Single Row Straight Pin Header for Potting

[查询"DF1B-4S-2.5R"供应商](#)

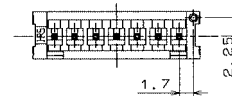
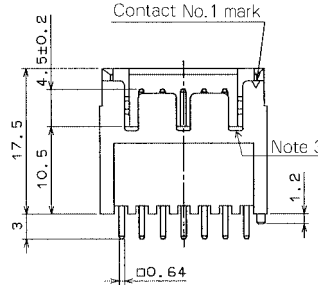
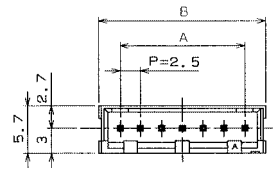
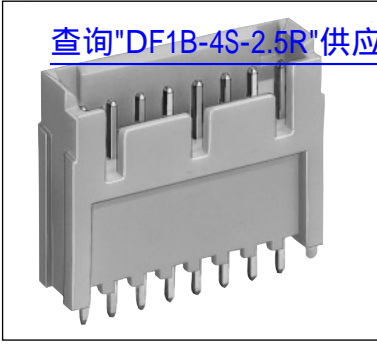

Tube Size

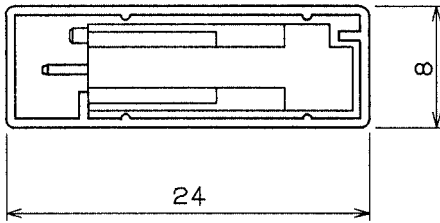

Unit: mm

Part Number	CL No.	Number of Contacts	A	B	Tube Package Quantity
DF1BD- 2P-2.5DSA(**)	541-0800-3-**-	2	2.5	7.5	64pieces
DF1BD- 3P-2.5DSA(**)	541-0801-6-**-	3	5	10	48
DF1BD- 4P-2.5DSA(**)	541-0802-9-**-	4	7.5	12.5	38
DF1BD- 5P-2.5DSA(**)	541-0803-1-**-	5	10	15	32
DF1BD- 6P-2.5DSA(**)	541-0804-4-**-	6	12.5	17.5	27
DF1BD- 7P-2.5DSA(**)	541-0805-7-**-	7	15	20	24
DF1BD- 8P-2.5DSA(**)	541-0806-0-**-	8	17.5	22.5	21
DF1BD- 9P-2.5DSA(**)	541-0807-2-**-	9	20	25	19
DF1BD-10P-2.5DSA(**)	541-0808-5-**-	10	22.5	27.5	17

- Board Positioning Boss Hole Diameter: $\phi 1.1^{+0.1}$
- Board Through-hole Diameter: $\phi 1.1^{+0.1}$

[Specific No.] -* *, (* *)
Blank: Tin plated
(20) : Tin plated, tube packaging

Note 1. A packaging quantity is delivered by the bag unit (100 pcs.). If needed, please order the product per pack.

Note 2. Please order the tube packaging products, multiplying the packaging quantity (pieces).

Note 3. The 2 and 3 contact connector contains the concave portion to prevent miss-insertion in the center at one point, which is different from the above figure. In addition, the 4 to 7 contacts connectors have two concave portions at both ends.

Applicable Potting Thickness : 6mm

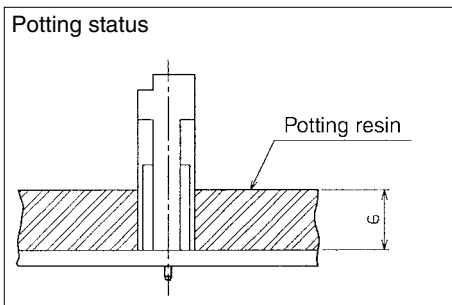

Double Row Straight Pin Header

[查询"DF1B-4S-2.5R"供应商](#)

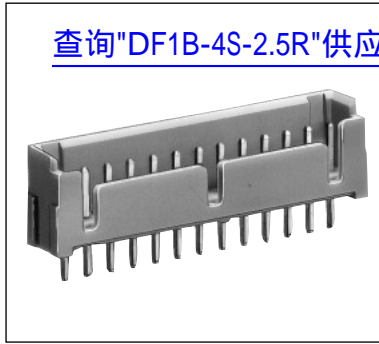

● Board Through-hole Diameter: $\phi 1.1^{+0.1}$

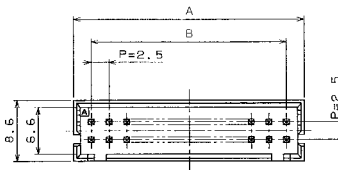

[Specific No.] -** , (**)
Blank: Tin plated
(01) : Gold plated

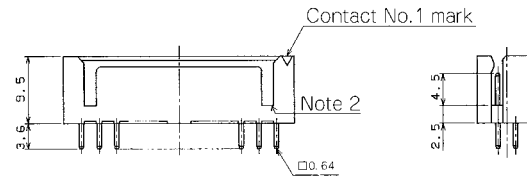

Unit: mm

Part Number	CL No.	Number of Contacts	A	B	Part Number	CL No.	Number of Contacts	A	B
DF1B- 4DP-2.5DSA(**)	541-0651-5-**	4	7.5	2.5	DF1B-20DP-2.5DSA(**)	541-0621-4-**	20	27.5	22.5
DF1B- 6DP-2.5DSA(**)	541-0652-8-**	6	10	5	DF1B-22DP-2.5DSA(**)	541-0622-7-**	22	30	25
DF1B- 8DP-2.5DSA(**)	541-0653-0-**	8	12.5	7.5	DF1B-24DP-2.5DSA(**)	541-0623-0-**	24	32.5	27.5
DF1B-10DP-2.5DSA(**)	541-0616-4-**	10	15	10	DF1B-26DP-2.5DSA(**)	541-0624-2-**	26	35	30
DF1B-12DP-2.5DSA(**)	541-0617-7-**	12	17.5	12.5	DF1B-28DP-2.5DSA(**)	541-0625-5-**	28	37.5	32.5
DF1B-14DP-2.5DSA(**)	541-0618-0-**	14	20	15	DF1B-30DP-2.5DSA(**)	541-0626-8-**	30	40	35
DF1B-16DP-2.5DSA(**)	541-0619-2-**	16	22.5	17.5	DF1B-34DP-2.5DSA(**)	541-0628-3-**	34	45	40
DF1B-18DP-2.5DSA(**)	541-0620-1-**	18	25	20	DF1B-40DP-2.5DSA(**)	541-0631-8-**	40	52.5	47.5

Note 1. The quantity at the specific No. "None" is delivered by the bag unit (100 pcs.). If needed, please order the product per bag.

Note 2. The 4 and 6 contact connector contains the concave portion to prevent miss-insertion in the center area at one point, which is different from the above figure.

Double Row Right Angle Pin Header

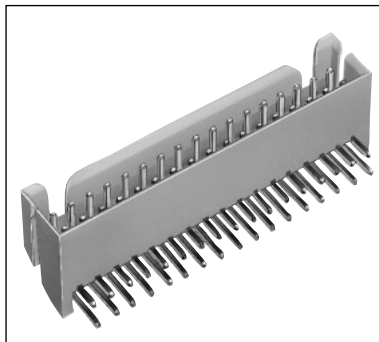

● Board Through-hole Diameter: $\phi 1.1^{+0.1}$

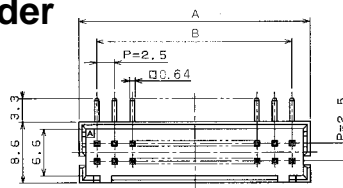

[Specific No.] -** , (**)
Blank: Tin plated
(01) : Gold plated

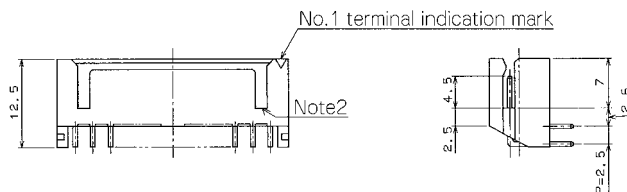

Unit: mm

Part Number	CL No.	Number of Contacts	A	B	Part Number	CL No.	Number of Contacts	A	B
DF1B- 4DP-2.5DS(**)	541-0654-3-**	4	7.5	2.5	DF1B-22DP-2.5DS(**)	541-0638-7-**	22	30	25
DF1B- 6DP-2.5DS(**)	541-0655-6-**	6	10	5	DF1B-24DP-2.5DS(**)	541-0639-0-**	24	32.5	27.5
DF1B- 8DP-2.5DS(**)	541-0656-9-**	8	12.5	7.5	DF1B-26DP-2.5DS(**)	541-0640-9-**	26	35	30
DF1B-10DP-2.5DS(**)	541-0632-0-**	10	15	10	DF1B-28DP-2.5DS(**)	541-0641-1-**	28	37.5	32.5
DF1B-12DP-2.5DS(**)	541-0633-3-**	12	17.5	12.5	DF1B-30DP-2.5DS(**)	541-0642-4-**	30	40	35
DF1B-14DP-2.5DS(**)	541-0634-6-**	14	20	15	DF1B-34DP-2.5DS(**)	541-0644-0-**	34	45	40
DF1B-16DP-2.5DS(**)	541-0635-9-**	16	22.5	17.5	DF1B-36DP-2.5DS(**)	541-0645-2-**	36	47.5	42.5
DF1B-18DP-2.5DS(**)	541-0636-1-**	18	25	20	DF1B-40DP-2.5DS(**)	541-0647-8-**	40	52.5	47.5
DF1B-20DP-2.5DS(**)	541-0637-4-**	20	27.5	22.5					

Note 1. The quantity at the specific No. "None" is delivered by the bag unit (100 pcs.). If needed, please order the product per bag.

Note 2. The 4 and 6 contact connector contains the concave portion to prevent miss-insertion in the center area at one point, which is different from the above figure.

Single Row In-line Plug(Simple Lock Type)

[查询"DF1B-4S-2.5R"供应商](#)

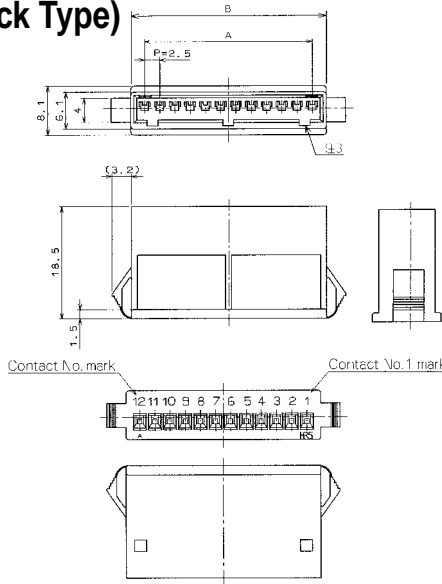
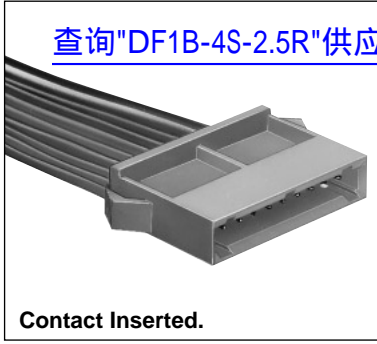

●Applicable Socket: DF1B-*S-2.5R

[Specific No.] -* *, (**)
Blank: Tin plated
(01) : Gold plated

Unit: mm

Part Number	CL No.	Number of Contacts	A	B	Part Number	CL No.	Number of Contacts	A	B
DF1BA- 2EP-2.5RC(**)	541-0700-9-*	2	2.5	7.1	DF1BA- 8EP-2.5RC**	541-0706-5-*	8	17.5	22.1
DF1BA- 3EP-2.5RC(**)	541-0701-1-*	3	5	9.6	DF1BA- 9EP-2.5RC**	541-0707-8-*	9	20	24.6
DF1BA- 4EP-2.5RC(**)	541-0702-4-*	4	7.5	12.1	DF1BA-10EP-2.5RC**	541-0708-0-*	10	22.5	27.1
DF1BA- 5EP-2.5RC(**)	541-0703-7-*	5	10	14.6	DF1BA-11EP-2.5RC**	541-0709-3-*	11	25	29.6
DF1BA- 6EP-2.5RC(**)	541-0704-0-*	6	12.5	17.1	DF1BA-12EP-2.5RC**	541-0710-2-*	12	27.5	32.1
DF1BA- 7EP-2.5RC(**)	541-0705-2-*	7	15	19.6	DF1BA-13EP-2.5RC**	541-0711-5-*	13	30	34.6

Note 1.The quantity at the specific No. "None" is delivered by the bag unit (100 pcs.). If needed, please order the product per bag.

Note 2.The 2 contacts connector contains the concave portion to prevent miss-insertion in the center area at one point, which is different from the above figure.In addition, the 3 to 7 contact connectors contain the concave portion at both sides.

Panel Cutouts

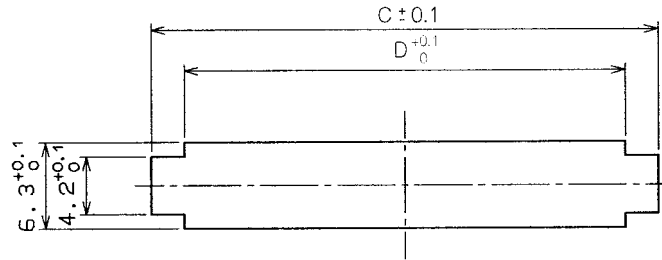

Unit: mm

Applicable Plug	Number of Contacts	C			D
		Panel Board Thickness (Note 1)			
		0.5 to 1.2	1.3 to 1.6	1.7 to 2.0	
DF1BA- 2EP-2.5RC(**)	2	11.2	11.9	12.6	7.3
DF1BA- 3EP-2.5RC(**)	3	13.7	14.4	15.1	9.8
DF1BA- 4EP-2.5RC(**)	4	16.2	16.9	17.6	12.3
DF1BA- 5EP-2.5RC(**)	5	18.7	19.4	20.1	14.8
DF1BA- 6EP-2.5RC(**)	6	21.2	21.9	22.6	17.3
DF1BA- 7EP-2.5RC(**)	7	23.7	24.4	25.1	19.8
DF1BA- 8EP-2.5RC(**)	8	26.2	26.9	27.6	22.3
DF1BA- 9EP-2.5RC(**)	9	28.7	29.4	30.1	24.8
DF1BA-10EP-2.5RC(**)	10	31.2	31.9	32.6	27.3
DF1BA-11EP-2.5RC(**)	11	33.7	34.4	35.1	29.8
DF1BA-12EP-2.5RC(**)	12	36.2	36.9	37.6	32.3
DF1BA-13EP-2.5RC(**)	13	38.7	39.4	40.1	34.8

Note 1.The installation hole size C according to panel board thickness.

Note 2.Fabricate installation holes so that no burr can occur.

Double Row In-line Plug (Simple Lock Type)

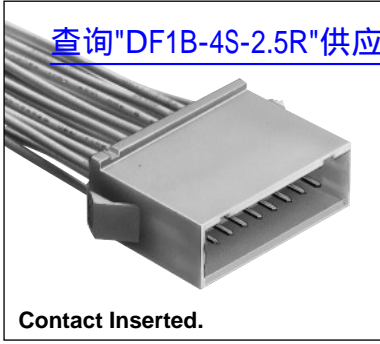

[查询"DF1B-4S-2.5R"供应商](#)

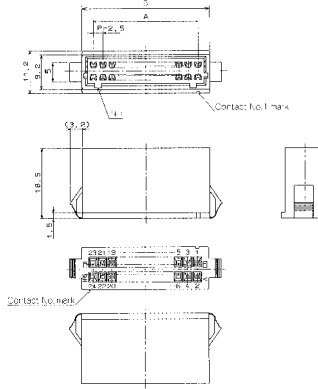

●Applicable Socket: DF1B-*DS-2.5RC

[Specific No.] -* *, (* *)
Blank: 100 pcs. per pack

Unit: mm

Part Number	CL No.	Number of Contacts	A	B	Part Number	CL No.	Number of Contacts	A	B
DF1BA- 4DEP-2.5RC(**)	541-0719-7-**	4	2.5	8.6	DF1BA-20DEP-2.5RC(**)	541-0727-5-**	20	22.5	28.6
DF1BA- 6DEP-2.5RC(**)	541-0720-6-**	6	5	11.1	DF1BA-22DEP-2.5RC(**)	541-0728-8-**	22	25	31.1
DF1BA- 8DEP-2.5RC(**)	541-0721-9-**	8	7.5	13.6	DF1BA-24DEP-2.5RC(**)	541-0729-0-**	24	27.5	33.6
DF1BA-10DEP-2.5RC(**)	541-0722-1-**	10	10	16.1	DF1BA-26DEP-2.5RC(**)	541-0730-0-**	26	30	36.1
DF1BA-12DEP-2.5RC(**)	541-0723-4-**	12	12.5	18.6	DF1BA-28DEP-2.5RC(**)	541-0731-2-**	28	32.5	38.6
DF1BA-14DEP-2.5RC(**)	541-0724-7-**	14	15	21.1	DF1BA-30DEP-2.5RC(**)	541-0732-5-**	30	35	41.1
DF1BA-16DEP-2.5RC(**)	541-0725-0-**	16	17.5	23.6	DF1BA-34DEP-2.5RC(**)	541-0734-0-**	34	40	46.1
DF1BA-18DEP-2.5RC(**)	541-0726-2-**	18	20	26.1					

Note 1.The quantity at the specific No. "None" is delivered by the bag unit (100 pcs.). If needed, please order the product per bag.

Note 2.The 4 contacts connector contains the concave portion to prevent miss-insertion in the center at one point, which is different from the above figure.

◆ Panel Cutouts

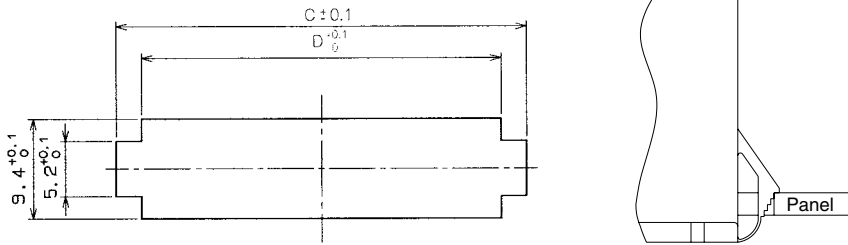

Unit: mm

Applicable Plug	Number of Contacts	C			D
		Panel Board Thickness (Note 1)			
		0.5 to 1.2	1.3 to 1.6	1.7 to 2.0	
DF1BA- 4DEP-2.5RC	4	12.7	13.4	14.1	8.8
DF1BA- 6DEP-2.5RC	6	15.2	15.9	16.6	11.3
DF1BA- 8DEP-2.5RC	8	17.7	18.4	19.1	13.8
DF1BA-10DEP-2.5RC	10	20.2	20.9	21.6	16.3
DF1BA-12DEP-2.5RC	12	22.7	23.4	24.1	18.8
DF1BA-14DEP-2.5RC	14	25.2	25.9	26.6	21.3
DF1BA-16DEP-2.5RC	16	27.7	28.4	29.1	23.8
DF1BA-18DEP-2.5RC	18	30.2	30.9	31.6	26.3
DF1BA-20DEP-2.5RC	20	32.7	33.4	34.1	28.8
DF1BA-22DEP-2.5RC	22	35.2	35.9	36.6	31.3
DF1BA-24DEP-2.5RC	24	37.7	38.4	39.1	33.8
DF1BA-26DEP-2.5RC	26	40.2	40.9	41.6	36.3
DF1BA-28DEP-2.5RC	28	42.7	43.4	44.1	38.8
DF1BA-30DEP-2.5RC	30	45.2	45.9	46.6	41.3
DF1BA-34DEP-2.5RC	34	50.2	50.9	51.6	46.3

Note 1.The installation hole size C according to panel board thickness.

Note 2.Fabricate installation holes so that no burr can occur.

Single Row In-line Socket (Full Lock Type)

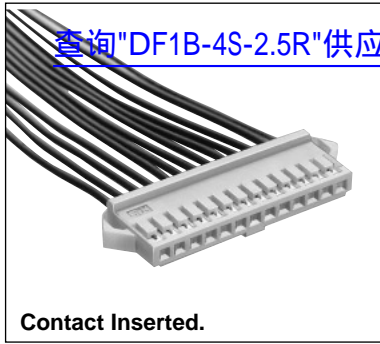

[查询"DF1B-4S-2.5R"供应商](#)

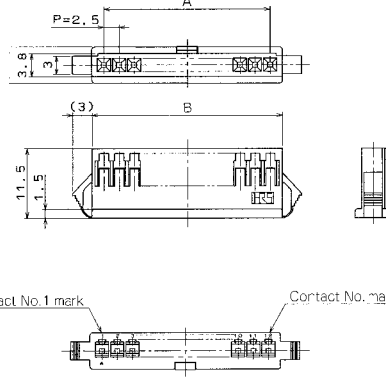

●Applicable Socket: DF1B-*DEP-2.5RC

[Specific No.] -* *, (* *)
Blank: 100 pcs. per pack

Unit: mm

Part Number	CL No.	Number of Contacts	A	B	Part Number	CL No.	Number of Contacts	A	B
DF1B- 2ES-2.5RC	541-0320-8-	2	2.5	6.5	DF1B- 8ES-2.5RC	541-0326-4-	8	17.5	21.5
DF1B- 3ES-2.5RC	541-0321-0-	3	5	9	DF1B- 9ES-2.5RC	541-0327-7-	9	20	24
DF1B- 4ES-2.5RC	541-0322-3-	4	7.5	11.5	DF1B-10ES-2.5RC	541-0328-0-	10	22.5	26.5
DF1B- 5ES-2.5RC	541-0323-6-	5	10	14	DF1B-11ES-2.5RC	541-0329-2-	11	25	29
DF1B- 6ES-2.5RC	541-0324-9-	6	12.5	16.5	DF1B-12ES-2.5RC	541-0330-1-	12	27.5	31.5
DF1B- 7ES-2.5RC	541-0325-1-	7	15	19	DF1B-13ES-2.5RC	541-0331-4-	13	30	34

Note 1.The quantity at the specific No. "None" is delivered by the bag unit (100 pcs.). If needed, please order the product per bag.

Panel Cutouts

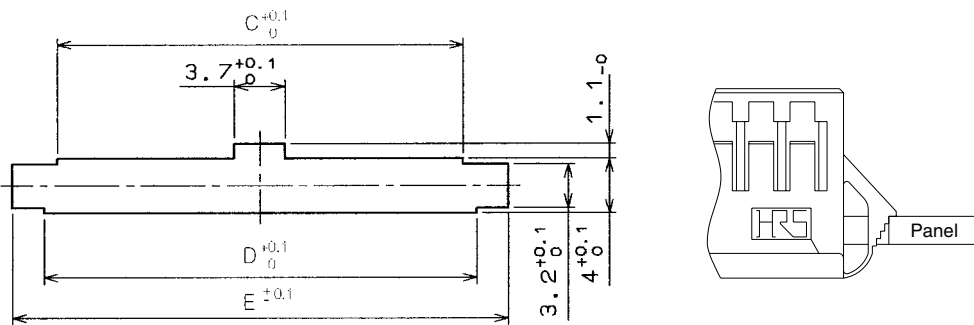

Unit: mm

Applicable Plug	Number of Contacts	C	D	E		
				Panel Board Thickness (Note 1)		
				0.5 to 1.2	1.3 to 1.6	1.7 to 2.0
DF1B- 2ES-2.5RC	2	4.7	6.7	10.8	11.3	12
DF1B- 3ES-2.5RC	3	7.2	9.2	13.3	13.8	14.5
DF1B- 4ES-2.5RC	4	9.7	11.7	15.8	16.3	17
DF1B- 5ES-2.5RC	5	12.2	14.2	18.3	18.8	19.5
DF1B- 6ES-2.5RC	6	14.7	16.7	20.8	21.3	22
DF1B- 7ES-2.5RC	7	17.2	19.2	23.3	23.8	24.5
DF1B- 8ES-2.5RC	8	19.7	21.7	25.8	26.3	27
DF1B- 9ES-2.5RC	9	22.2	24.2	28.3	28.8	29.5
DF1B-10ES-2.5RC	10	24.7	26.7	30.8	31.3	32
DF1B-11ES-2.5RC	11	27.2	29.2	33.3	33.8	34.5
DF1B-12ES-2.5RC	12	29.7	31.7	35.8	36.3	37
DF1B-13ES-2.5RC	13	32.2	34.2	38.3	38.8	39.5

Note 1.The installation hole size C will be changed according to panel board thickness.

Note 2.Fabricate installation holes so that no burr can occur.

Double Row In-line Socket (Full Lock Type)

[查询"DF1B-4S-2.5R"供应商](#)

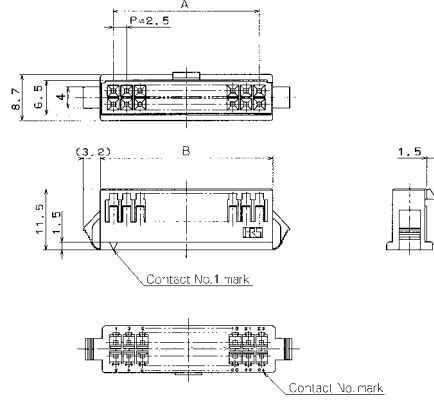
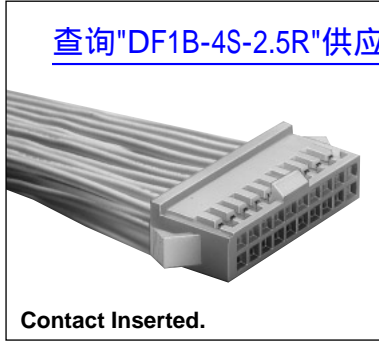

●Applicable Socket: DF1B-*EP-2.5RC

[Specific No.] -* *, (* *)
Blank: 100 pcs. per pack

Unit: mm

Part Number	CL No.	Number of Contacts	A	B	Part Number	CL No.	Number of Contacts	A	B
DF1B-10DES-2.5RC(**)	541-0351-1-*	10	10	15	DF1B-24DES-2.5RC(**)	541-0357-8-*	24	27.5	32.5
DF1B-12DES-2.5RC(**)	541-0352-4-*	12	12.5	17.5	DF1B-26DES-2.5RC(**)	541-0358-0-*	26	30	35
DF1B-14DES-2.5RC(**)	541-0353-7-*	14	15	20	DF1B-28DES-2.5RC(**)	541-0359-3-*	28	32.5	37.5
DF1B-16DES-2.5RC(**)	541-0354-0-*	16	17.5	22.5	DF1B-30DES-2.5RC(**)	541-0360-2-*	30	35	40
DF1B-18DES-2.5RC(**)	541-0346-1-*	18	20	25	DF1B-32DES-2.5RC(**)	541-0361-5-*	32	37.5	42.5
DF1B-20DES-2.5RC(**)	541-0355-2-*	20	22.5	27.5	DF1B-34DES-2.5RC(**)	541-0362-8-*	34	40	45
DF1B-22DES-2.5RC(**)	541-0356-5-*	22	25	30					

Note 1. The quantity at the specific No. "None" is delivered by the bag unit (100 pcs.). If needed, please order the product per bag.

Panel Cutouts

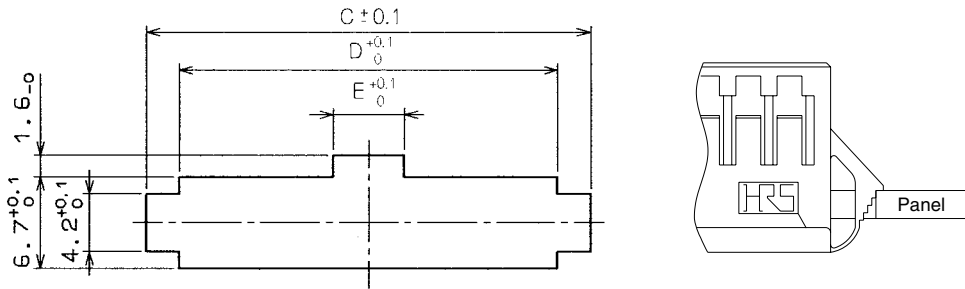

Unit: mm

Applicable Plug	Number of Contacts	C			D	E
		Panel Board Thickness (Note 1)				
		0.5 to 1.2	1.3 to 1.6	1.7 to 2.0		
DF1B-10DES-2.5RC(**)	10	19.1	19.8	20.5	15.2	3.7
DF1B-12DES-2.5RC(**)	12	21.6	22.3	23	17.7	3.7
DF1B-14DES-2.5RC(**)	14	24.1	24.8	25.5	20.2	3.7
DF1B-16DES-2.5RC(**)	16	26.6	27.3	28	22.7	3.7
DF1B-18DES-2.5RC(**)	18	29.1	29.8	30.5	25.2	3.7
DF1B-20DES-2.5RC(**)	20	31.6	32.3	33	27.7	5.2
DF1B-22DES-2.5RC(**)	22	34.1	34.8	35.5	30.2	5.2
DF1B-24DES-2.5RC(**)	24	36.6	37.3	38	32.7	5.2
DF1B-26DES-2.5RC(**)	26	39.1	39.8	40.5	35.2	5.2
DF1B-28DES-2.5RC(**)	28	41.6	42.3	43	37.7	5.2
DF1B-30DES-2.5RC(**)	30	44.1	44.8	45.5	40.2	5.2
DF1B-32DES-2.5RC(**)	32	46.6	47.3	48	42.7	5.2
DF1B-34DES-2.5RC(**)	34	49.1	49.8	50.5	45.2	5.2

Note 1. The installation hole size C according to panel board thickness.

Note 2. Fabricate installation holes so that no burr can occur.

Single Row In-line Plug (Full Lock Type)

[查询"DF1B-4S-2.5R"供应商](#)

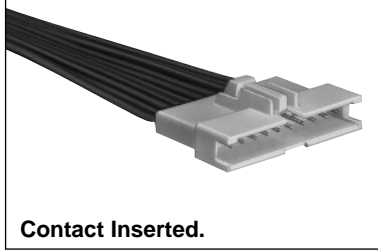

Contact Inserted.

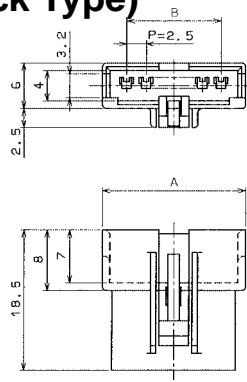

● Applicable Socket: DF1B-*ES-2.5RC

[Specific No.] - * *, (* *)
Blank: 100 pcs. per pack

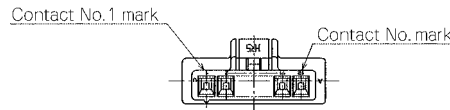
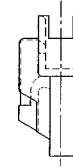

Unit: mm

Part Number	CL No.	Number of Contacts	A	B	Part Number	CL No.	Number of Contacts	A	B
DF1B- 2EP-2.5RC(**)	541-0332-7-*	2	8.9	2.5	DF1B- 8EP-2.5RC(**)	541-0338-3-*	8	23.9	17.5
DF1B- 3EP-2.5RC(**)	541-0333-0-*	3	11.4	5	DF1B- 9EP-2.5RC(**)	541-0339-6-*	9	26.4	20
DF1B- 4EP-2.5RC(**)	541-0334-2-*	4	13.9	7.5	DF1B-10EP-2.5RC(**)	541-0340-5-*	10	28.9	22.5
DF1B- 5EP-2.5RC(**)	541-0335-5-*	5	16.4	10	DF1B-11EP-2.5RC(**)	541-0341-8-*	11	31.4	25
DF1B- 6EP-2.5RC(**)	541-0336-8-*	6	18.9	12.5	DF1B-12EP-2.5RC(**)	541-0342-0-*	12	33.9	27.5
DF1B- 7EP-2.5RC(**)	541-0337-0-*	7	21.4	15	DF1B-13EP-2.5RC(**)	541-0343-3-*	13	36.4	30

Note 1. The quantity at the specific No. "None" is delivered by the bag unit (100 pcs.). If needed, please order the product per bag.

Double Row In-line Plug (Full Lock Type)

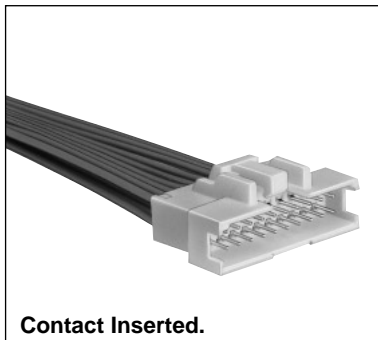

Contact Inserted.

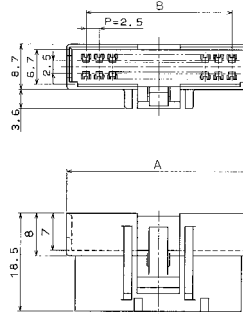

● Applicable Socket: DF1B-*DES-2.5RC

[Specific No.] - * *, (* *)
Blank: 100 pcs. per pack

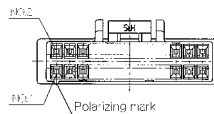
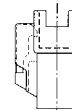

Unit: mm

Part Number	CL No.	Number of Contacts	A	B	Part Number	CL No.	Number of Contacts	A	B
DF1B-10DEP-2.5RC(**)	541-0366-9-*	10	17.2	10	DF1B-24DEP-2.5RC(**)	541-0372-1-*	24	34.7	27.5
DF1B-12DEP-2.5RC(**)	541-0367-1-*	12	19.7	12.5	DF1B-26DEP-2.5RC(**)	541-0373-4-*	26	37.2	30
DF1B-14DEP-2.5RC(**)	541-0368-4-*	14	22.2	15	DF1B-28DEP-2.5RC(**)	541-0374-7-*	28	39.7	32.5
DF1B-16DEP-2.5RC(**)	541-0369-7-*	16	24.7	17.5	DF1B-30DEP-2.5RC(**)	541-0375-0-*	30	42.2	35
DF1B-18DEP-2.5RC(**)	541-0350-9-*	18	27.2	20	DF1B-32DEP-2.5RC(**)	541-0376-2-*	32	44.7	37.5
DF1B-20DEP-2.5RC(**)	541-0370-6-*	20	29.7	22.5	DF1B-34DEP-2.5RC(**)	541-0377-5-*	34	47.2	40
DF1B-22DEP-2.5RC(**)	541-0371-9-*	22	32.2	25					

Note 1. The quantity at the specific No. "None" is delivered by the bag unit (100 pcs.). If needed, please order the product per bag.

■ ID Contact for Socket

[查询"DF1B-4S-2.5R"供应商](#)

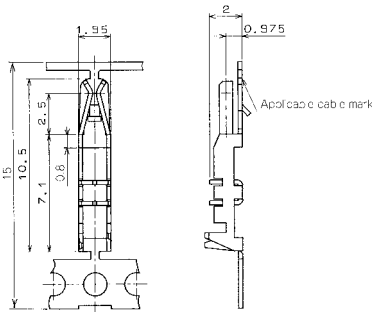

Unit: mm

Part Number	CL No.	Applicable Cable Indication	Applicable Cable				Packaging Type	Quantity	Finish	
			AWG	UL Style	Wire Construction	Jacket Diameter				
DF1B-R24F	541-0217-9	24	AWG 24	1061	11 cores./0.16mm	0.9 to 1.39mm	Reel	10000	Tin plated	
DF1B-R24	541-0220-3						Bag	100		
DF1B-R26F	541-0218-1	26	AWG 26	1061 1007	7 cores./0.16mm	0.9 to 1.39mm	Reel	10000		
DF1B-R26	541-0221-6						Bag	100		
DF1B-R28F	541-0219-4	28	AWG 28	1061 1007	7 cores./0.127mm	0.9 to 1.39mm	Reel	10000		
DF1B-R28	541-0222-9						Bag	100		
DF1B-R24FA	541-0261-0	24	AWG 24	1061	11 cores./0.16mm	0.9 to 1.39mm	Reel	10000		Gold plated
DF1B-R24A	541-0264-9						Bag	100		
DF1B-R26FA	541-0262-3	26	AWG 26	1061 1007	7 cores./0.16mm	0.9 to 1.39mm	Reel	10000		
DF1B-R26A	541-0265-1						Bag	100		
DF1B-R28FA	541-0263-6	28	AWG 28	1061 1007	7 cores./0.127mm	0.9 to 1.39mm	Reel	10000		
DF1B-R28A	541-0266-4						Bag	100		

● ID Contact Extraction Tool DF-C-PO (A)

Note 1.The applicable cable conductor is the tin plated annealing copper wire.

Note 2.If other cables are used instead of the applicable cable, cotact Hirose sales department.

■ Crimping Contact for Socket

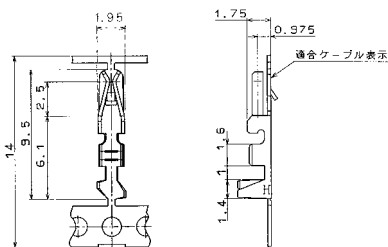

● Applicable Cable (Tin Plated Annealing Copper Wire)

Conductor Size (Wire construction)
AWG20 (21cores/0.18mm)
AWG22 (17cores/0.16mm)
AWG24 (11cores/0.16mm)
AWG26 (7cores/0.16mm)
AWG28 (7cores/0.127mm)
AWG30 (7cores/0.1mm)

● Recommended Cable

UL1061, UL1007

● Strip Length

2.0 to 2.5mm

Note:If other cables are used instead of the applicable cable, consult Hirose sales department.

Unit: mm

Part Number	CL No.	Applicable Cable Indication	Applicable Cable		Packaging Type	Quantity	Finish
			AWG	Jacket Diameter			
DF1B-2022SCF	541-0223-1	20	AWG 20 to	1.2 to 1.9mm	Reel	10000	Tin plated
DF1B-2022SC	541-0224-4	22	AWG 22				
DF1B-2428SCF	541-0678-1	24	AWG 24 to	0.9 to 1.5mm	Reel	10000	
DF1B-2428SC	541-0679-4	28	AWG 28				
DF1B-30SCF	541-0682-9	30	AWG 30	0.6 to 1.2mm	Reel	10000	
DF1B-30SC	541-0683-1				Bag	100	
DF1B-2022SCFA	541-0662-1	20	AWG 20 to	1.2 to 1.9mm	Reel	10000	Gold plated
DF1B-2022SCA	541-0663-4	22	AWG 22				
DF1B-2428SCFA	541-0680-3	24	AWG 24 to	0.9 to 1.5mm	Reel	10000	
DF1B-2428SCA	541-0681-6	28	AWG 28				
DF1B-30SCFA	541-0684-4	30	AWG 30	0.6 to 1.2mm	Reel	10000	
DF1B-30SCA	541-0685-7				Bag	100	

● Crimping Contact Extraction Tool DF-C-PO (B)

■ ID Contact for Plug

[查询"DF1B-4S-2.5R"供应商](#)

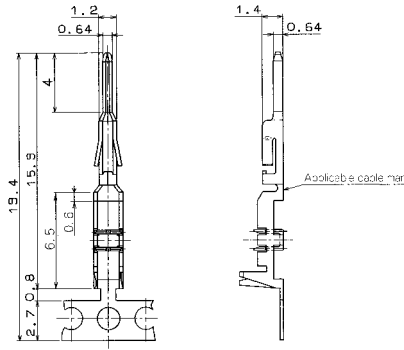

Unit: mm

Part Number	CL No.	Applicable Cable Indication	Applicable Cable				Packaging Type	Quantity	Finish	
			AWG	UL Style	Wire structure	Jacket Diameter				
DF1B-24PRF	541-0666-2	24	AWG 24	1061	11 pcs./0.16mm	0.9 to 1.39mm	Reel	10000	Tin plated	
DF1B-24PR	541-0667-5						Bag	100		
DF1B-26PRF	541-0668-8	26	AWG 26	1061	7 pcs./0.16mm	0.9 to 1.39mm	Reel	10000		
DF1B-26PR	541-0669-0						Bag	100		
DF1B-28PRF	541-0670-0	28	AWG 28	1061	7 pcs./0.127mm	0.9 to 1.39mm	Reel	10000		
DF1B-28PR	541-0671-2						Bag	100		
DF1B-24PRFB	541-0672-5	24	AWG 24	1061	11 pcs./0.16mm	0.9 to 1.39mm	Reel	10000		Gold plated
DF1B-24PRB	541-0673-8						Bag	100		
DF1B-26PRFB	541-0674-0	26	AWG 26	1061	7 pcs./0.16mm	0.9 to 1.39mm	Reel	10000		
DF1B-26PRB	541-0675-3						Bag	100		
DF1B-28PRFB	541-0676-6	28	AWG 28	1061	7 pcs./0.127mm	0.9 to 1.39mm	Reel	10000		
DF1B-28PRB	541-0677-9						Bag	100		

● ID Contact Extraction Tool DF-C-PO (C)

Note 1.The applicable cable conductor is the tin plated annealing copper wire.

Note 2.If other cables are used instead of the applicable cable, contact Hirose sales department.

■ Crimping Contact for Plug

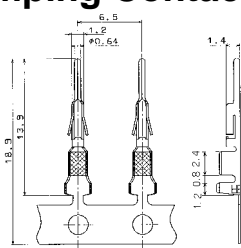

● Applicable Cable (Tin Plated Annealing Copper Wire)

Conductor Size (Contact wire construction)
AWG20 (21 pieces/0.18mm)
AWG22 (17 pieces/0.16mm)
AWG24 (11 pieces/0.16mm)
AWG26 (7 pieces/0.16mm)
AWG28 (7 pieces/0.127mm)
AWG30 (7 pieces/0.1mm)

● Recommended Cable

UL1061, UL1007

● Strip Length

3.0 to 3.7mm

Note:If other cables are used instead of the applicable cable, consult Hirose sales department.

Unit: mm

Part Number	CL No.	Applicable Cable		Packaging Type	Quantity	Treatment
		AWG	Jacket Diameter			
DF1B-2022PCF	541-0259-9	AWG 20 to	1.2 to 1.9mm	Reel	10000	Tin plated
DF1B-2022PC	541-0260-8	AWG 22		Bag	100	
DF1B-2428PCF	541-0664-7	AWG 24 to	0.9 to 1.5mm	Reel	10000	
DF1B-2428PC	541-0665-0	AWG 28		Bag	100	
DF1B-30PCF	541-0686-0	AWG 30	0.6 to 1.2mm	Reel	10000	
DF1B-30PC	541-0687-2			Bag	100	
DF1B-2022PCFB	541-0690-7	AWG 20 to	1.2 to 1.9mm	Reel	10000	Gold plated
DF1B-2022PCB	541-0691-0	AWG 22		Bag	100	
DF1-PD2428SCFB	541-0660-6	AWG 24 to	0.9 to 1.5mm	Reel	10000	
DF1-PD2428SCB	541-0661-9	AWG 28		Bag	100	
DF1B-30PCFB	541-0688-5	AWG 30	0.6 to 1.2mm	Reel	10000	
DF1B-30PCB	541-0689-8			Bag	100	

● Crimping Contact Extraction Tool DF-C-PO (C)

◆ Applicable Tool

[查询"DF1B-4S-2.5R"供应商](#)



[Press Main Unit and Applicator]



[Manual Crimping Tool]

Connection Type	Type	Part Number	CL No.	Applicable Contacts
ID	Applicator	AP105-DF1B-R	901-4507-4	DF1B-R**F/FA **=24,26,28
		AP105-DF1B-PR	901-4536-2	DF1B-**PRF/PRFB**=24,26,28
	Manual ID tool	DF1B-T2428HR	550-0171-0	DF1B-R**/A **=24,26,28
		DF1B-T2428PHR	550-0221-7	DF1B-**PR/PRB **=24,26,28
Crimping	Applicator	AP105-DF1B-2022S	901-4510-9	DF1B-2022SCF/SCFA
		AP105-DF1B-2428S	901-4518-0	DF1B-2428SCF/SCFA
		AP105-DF1B-30S	901-4517-8	DF1B-30SCF/SCFA
		AP105-DF1B-2022P	901-4509-0	DF1B-2022PCF/PCFB
		AP105-DF1B-2428P	901-4521-5	DF1B-2428PCF,DF1-PD2428SCF/SCFB
		AP105-DF1B-30P	901-4519-3	DF1B-30PCF/PCFB
	Manual crimping tool	DF1B-TA2022SHC	550-0182-7	DF1B-2022SC/SCA
		DF1B-TA2428SHC	550-0209-1	DF1B-2428SC/SCA
		DF1B-TA30SHC	550-0211-3	DF1B-30SC/SCA
		DF1B-TA2022PHC	550-0183-0	DF1B-2022PC/PCB
		DF1B-TA2428PHC	550-0224-5	DF1B-2428PC,DF1-PD2428SCB
		DF1B-TA30PHC	550-0210-0	DF1B-30PC/PCB
Press Main Unit		CM-105	901-0005-4	—————
Extraction Tool		DF-C-PO(A)	550-0170-8	DF1B-R**F
		DF-C-PO(B)	550-0179-2	DF1B-***SCF
		DF-C-PO(C)	550-0198-7	DF1B-***PC,DF1B-**PRF

Note: If a trouble has occurred due to tools which are not designated by Hirose, Hirose won't guarantee any product

◆ Applicable Tool

[查询"DF1B-4S-2.5R"供应商](#)

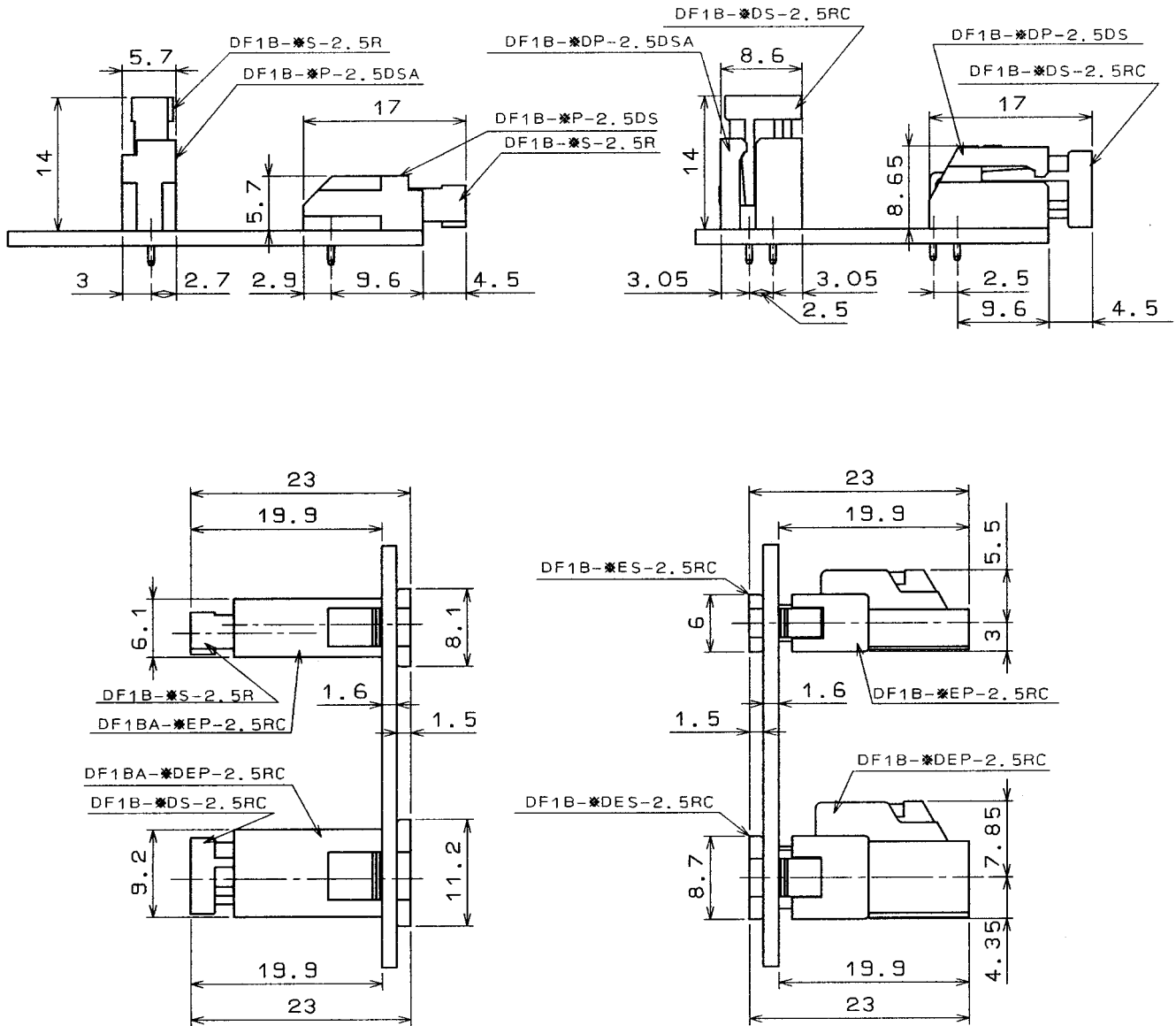

◆ Precautions

1. Recommended Soldering Condition	Flow: 250°C for 3 seconds Manual soldering: 290°C for 2 seconds
2. Cleaning Condition	Refer to Nylon Connector Use Hand book.
3. Connection Condition	Refer to Nylon Connector Use Hand book.
4. Cautions	<ul style="list-style-type: none"> ■The color phase of this product is slightly different from that of the formed product according to the manufacturing lot and future storage conditions, but the difference doesn't affect the performance.