

SERIES: ACZ16

DESCRIPTION: mechanical incremental encoder

ELECTRICAL SPECIFICATIONS

parameter	conditions/description
output waveform	square wave
output signals	A, B phase
current consumption	0.5 mA
output phase difference	T1, T2, T3, T4 \geq 3.5 ms @ 60 rpm (see output waveform)
supply voltage	5 V dc max.
output resolution	12, 24 ppr
insulation resistance	50 V dc, 100 M Ω
withstand voltage	50 V ac

MECHANICAL SPECIFICATIONS

parameter	conditions/description	min	nom	max	units
shaft load	axial			7	kgf
rotational torque	with detent click without detent click	50 90		130 210	gf·cm gf·cm
rotational life				100,000	cycles

ENVIRONMENTAL SPECIFICATIONS

parameter	conditions/description	min	nom	max	units
operating temperature		-10		65	$^{\circ}$ C
storage temperature		-40		75	$^{\circ}$ C
humidity		85			% RH
vibration	0.75 mm max. travel for 2 hours	10		55	Hz

PART NUMBER KEY

ACZ16 X BR X E- XX XX X1- XXX

Version:
"blank" = switch
N = no switch

Shaft length:
15, 20, 25

Bushing:
1 = M7 x 0.75 (H = 5)
2 = M7 x 0.75 (H = 7)
4 = smooth (H = 5)
5 = smooth (H = 7)

Shaft type:
KQ, F

Mounting orientation:
A = Horizontal
D = Vertical

Resolution (ppr):
12 = 12 ppr, no detent
12C = 12 ppr, 12 detent
24 = 24 ppr, no detent
24C = 24 ppr, 24 detent



SERIES: ACZ16

DESCRIPTION: mechanical incremental encoder

SHAFT OPTIONS

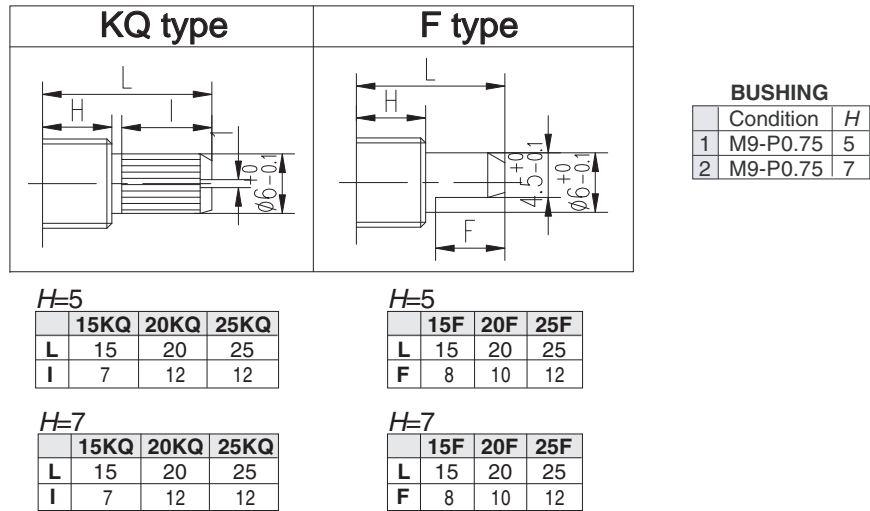

OUTPUT WAVEFORM

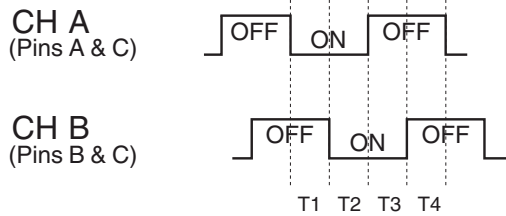

CW direction (@ 60 rpm)

DETENT POSITIONS

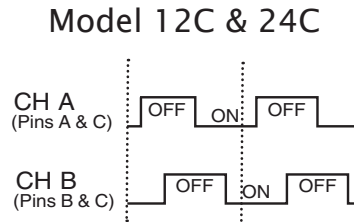

SLIDING NOISE

t = Masking time to avoid chatter (5mS) $V_1 = V_2 = 1V$ max.

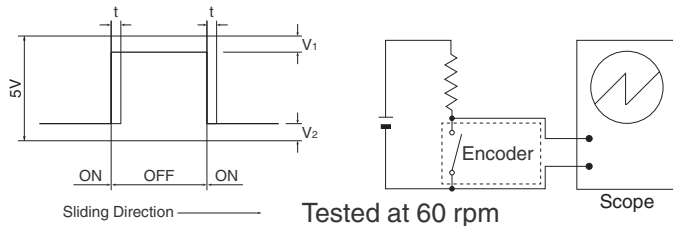

SUGGESTED FILTER

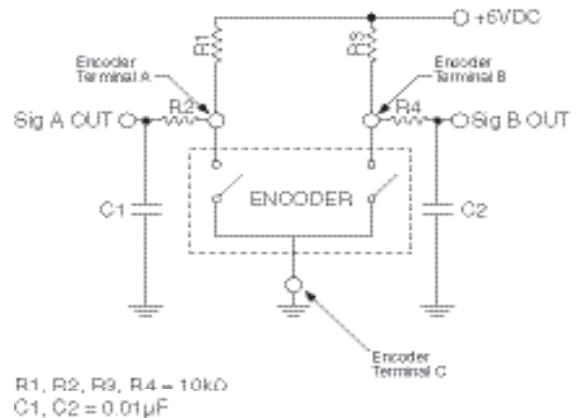

SERIES: ACZ16

DESCRIPTION: mechanical incremental encoder

MECHANICAL DRAWING (horizontal)

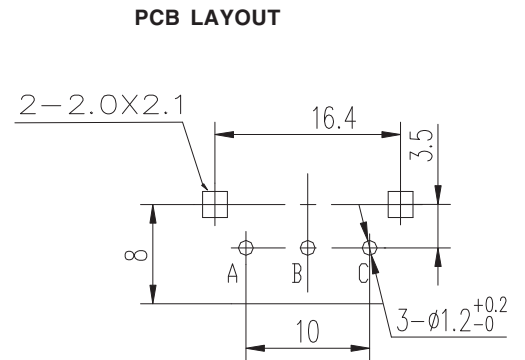
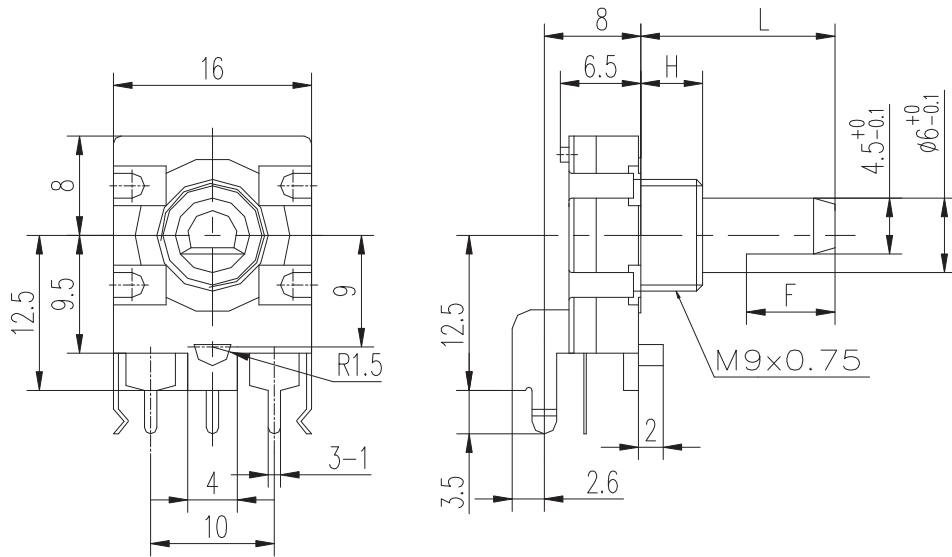

MECHANICAL DRAWING (vertical)

