



February 1994  
Revised April 2001

## 74LCX16652 Low Voltage Transceiver/Register with 5V Tolerant Inputs and Outputs

### General Description

The LCX16652 contains sixteen non-inverting bidirectional bus transceivers with 3-STATE outputs providing multiplexed transmission of data directly from the input bus or from the internal registers. Data on the A or B bus will be clocked into the registers as the appropriate clock pin goes to the HIGH logic level. Output Enable pins (OEAB, OEBA) are provided to control the transceiver function (see Functional Description).

The LCX16652 is designed for low-voltage (2.5V or 3.3V)  $V_{CC}$  applications with capability of interfacing to a 5V signal environment.

The LCX16652 is fabricated with an advanced CMOS technology to achieve high speed operation while maintaining CMOS low power dissipation.

### Features

- 5V tolerant inputs and outputs
- 2.3V–3.6V  $V_{CC}$  specifications provided
- 5.7 ns  $t_{PD}$  max ( $V_{CC} = 3.3V$ ), 20  $\mu A$   $I_{CC}$  max
- Power down high impedance inputs and outputs
- Supports live insertion/withdrawal (Note 1)
- $\pm 24$  mA output drive ( $V_{CC} = 3.0V$ )
- Implements patented noise/EMI reduction circuitry
- Latch-up performance exceeds 500 mA
- ESD performance:
  - Human body model > 2000V
  - Machine model > 200V

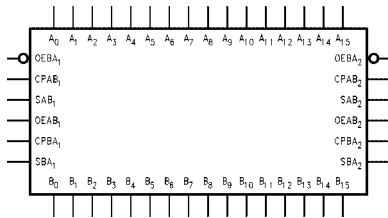
**Note 1:** To ensure the high-impedance state during power up or down,  $\overline{OE}$  should be tied to  $V_{CC}$  and OE tied to GND through a resistor: the minimum value or the resistor is determined by the current-sourcing capability of the driver.

### Ordering Code:

Order Number	Package Number	Package Description
74LCX16652MEA	MS56A	56-Lead Shrink Small Outline Package (SSOP), JEDEC MO-118, 0.300 Wide
74LCX16652MTD	MTD56	56-Lead Thin Shrink Small Outline Package (TSSOP), JEDEC MO-153, 6.1mm Wide

Devices also available in Tape and Reel. Specify by appending the suffix letter "X" to the ordering code.

### Logic Symbol



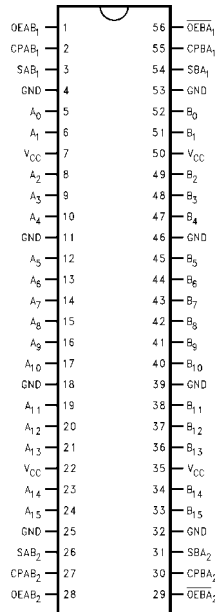
### Pin Descriptions

Pin Names	Description
$A_0$ – $A_{15}$	Data Register A Inputs/3-STATE Outputs
$B_0$ – $B_{15}$	Data Register B Inputs/3-STATE Outputs
$CPAB_n$ , $CPBA_n$	Clock Pulse Inputs
$SAB_n$ , $SBA_n$	Select Inputs
$OEAB_n$ , $\overline{OEBA}_n$	Output Enable Inputs

74LCX16652 Low Voltage Transceiver/Register with 5V Tolerant Inputs and Outputs

74LCX16652

Connection Diagram



Truth Table

(Note 2)

Inputs						Inputs/Outputs		Operating Mode
OEAB	OEBA <sub>1</sub>	CPAB <sub>1</sub>	CPBA <sub>1</sub>	SAB <sub>1</sub>	SBA <sub>1</sub>	A <sub>0</sub> thru A <sub>7</sub>	B <sub>0</sub> thru B <sub>7</sub>	
L	H	H or L	H or L	X	X	Input	Input	Isolation
L	H	↗	↗	X	X	Input	Input	Store A and B Data
X	H	↗	H or L	X	X	Input	Not Specified	Store A, Hold B
H	H	↗	↗	X	X	Input	Output	Store A in Both Registers
L	X	H or L	↗	X	X	Not Specified	Input	Hold A, Store B
L	L	↗	↗	X	X	Output	Input	Store B in Both Registers
L	L	X	X	X	L	Output	Input	Real-Time B Data to A Bus
L	L	X	H or L	X	H	Output	Input	Store B Data to A Bus
H	H	X	X	L	X	Input	Output	Real-Time A Data to B Bus
H	H	H or L	X	H	X	Input	Output	Stored A Data to B Bus
H	L	H or L	H or L	H	H	Output	Output	Stored A Data to B Bus and Stored B Data to A Bus

H = HIGH Voltage Level  
 L = LOW Voltage Level  
 X = Immaterial  
 ↗ = LOW-to-HIGH Clock Transition

**Note 2:** The data output functions may be enabled or disabled by various signals at OEAB or OEBA inputs. Data input functions are always enabled, i.e., data at the bus pins will be stored on every LOW-to-HIGH transition on the clock inputs. This also applies to data I/O (A and B: 8–15) and #2 control pins.

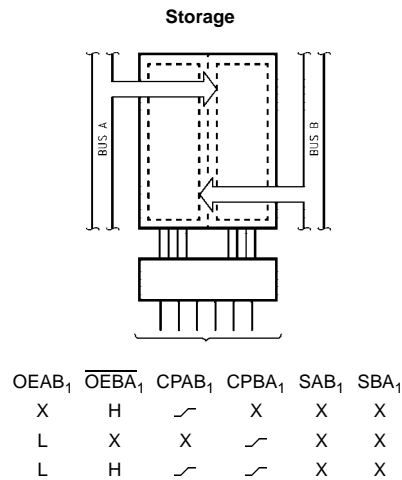
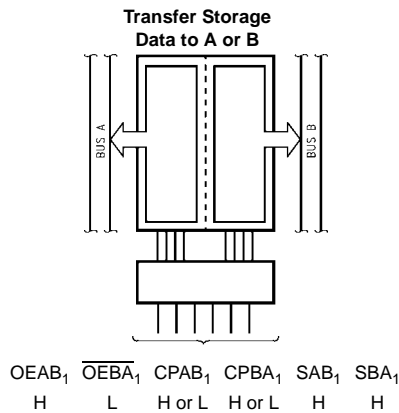
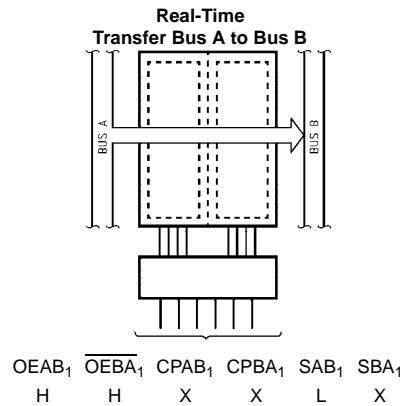
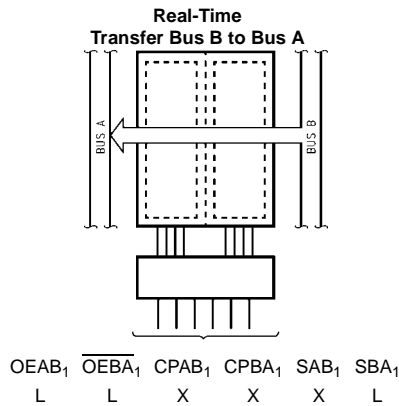
### Functional Description

In the transceiver mode, data present at the HIGH impedance port may be stored in either the A or B register or both.

The select ( $SAB_n$ ,  $SBA_n$ ) controls can multiplex stored and real-time.

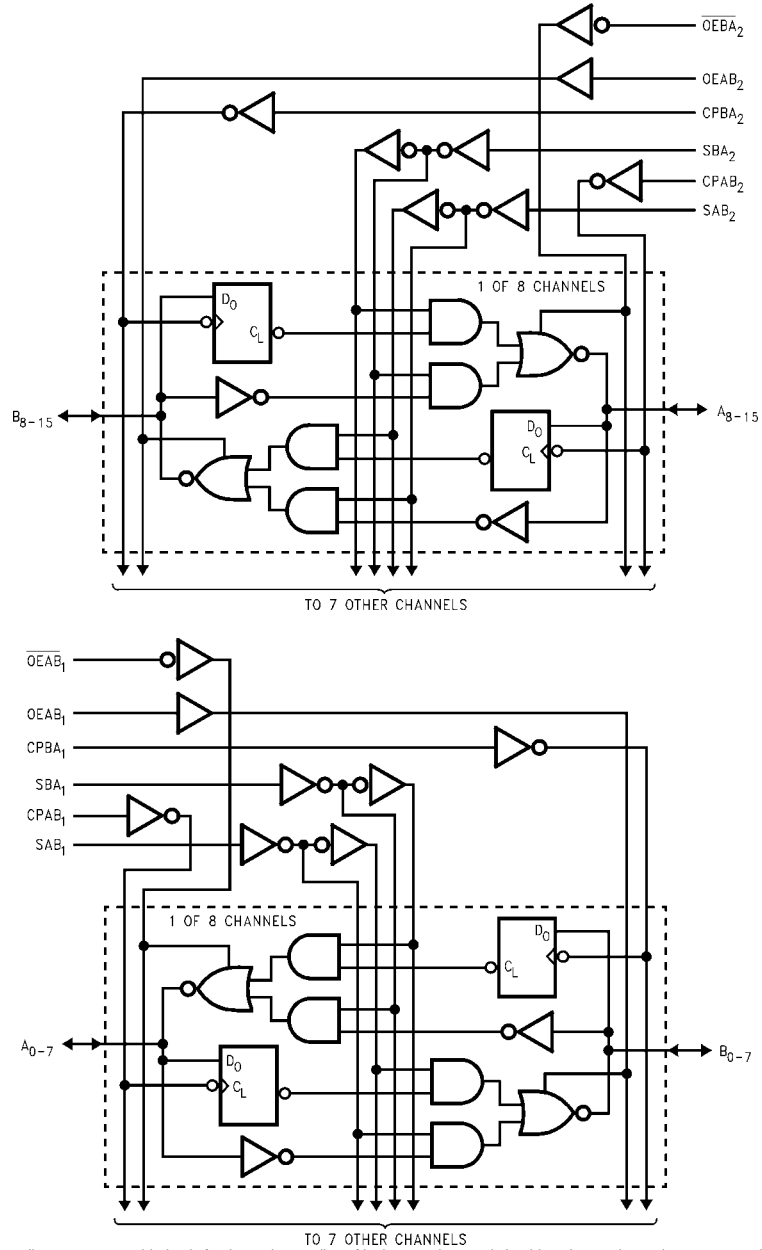
The examples below demonstrate the four fundamental bus-management functions that can be performed with the 74LCX16652.

Data on the A or B data bus, or both can be stored in the internal D flip-flop by LOW-to-HIGH transitions at the appropriate Clock Inputs ( $CPAB_n$ ,  $CPBA_n$ ) regardless of the Select or Output Enable Inputs. When  $SAB$  and  $SBA$  are in the real time transfer mode, it is also possible to store data without using the internal D flip-flops by simultaneously enabling  $OEAB_n$  and  $\overline{OEBA}_n$ . In this configuration each Output reinforces its Input. Thus when all other data sources to the two sets of bus lines are in a HIGH impedance state, each set of bus lines will remain at its last state.



74LCX16652

Logic Diagram



Please note that these diagrams are provided only for the understanding of logic operations and should not be used to estimate propagation delays.

Absolute Maximum Ratings (Note 3)					
Symbol	Parameter	Value	Conditions	Units	
V <sub>CC</sub>	Supply Voltage	-0.5 to +7.0		V	
V <sub>I</sub>	DC Input Voltage	-0.5 to +7.0		V	
V <sub>O</sub>	DC Output Voltage	-0.5 to +7.0 -0.5 to V <sub>CC</sub> + 0.5	Output in 3-STATE Output in HIGH or LOW State (Note 4)	V	
I <sub>IK</sub>	DC Input Diode Current	-50	V <sub>I</sub> < GND	mA	
I <sub>OK</sub>	DC Output Diode Current	-50 +50	V <sub>O</sub> < GND V <sub>O</sub> > V <sub>CC</sub>	mA	
I <sub>O</sub>	DC Output Source/Sink Current	±50		mA	
I <sub>CC</sub>	DC Supply Current per Supply Pin	±100		mA	
I <sub>GND</sub>	DC Ground Current per Ground Pin	±100		mA	
T <sub>STG</sub>	Storage Temperature	-65 to +150		°C	

Recommended Operating Conditions (Note 5)					
Symbol	Parameter	Min	Max	Units	
V <sub>CC</sub>	Supply Voltage	Operating	2.0	3.6	V
		Data Retention	1.5	3.6	
V <sub>I</sub>	Input Voltage	0	5.5	V	
V <sub>O</sub>	Output Voltage	HIGH or LOW State	0	V <sub>CC</sub>	V
		3-STATE	0	5.5	
I <sub>OH</sub> /I <sub>OL</sub>	Output Current	V <sub>CC</sub> = 3.0V – 3.6V		±24	mA
		V <sub>CC</sub> = 2.7V – 3.0V		±12	
		V <sub>CC</sub> = 2.3V – 2.7V		±8	
T <sub>A</sub>	Free-Air Operating Temperature	-40	85	°C	
Δt/ΔV	Input Edge Rate, V <sub>IN</sub> = 0.8V–2.0V, V <sub>CC</sub> = 3.0V	0	10	ns/V	

**Note 3:** The Absolute Maximum Ratings are those values beyond which the safety of the device cannot be guaranteed. The device should not be operated at these limits. The parametric values defined in the Electrical Characteristics tables are not guaranteed at the Absolute Maximum Ratings. The "Recommended Operating Conditions" table will define the conditions for actual device operation.

**Note 4:** I<sub>O</sub> Absolute Maximum Rating must be observed.

**Note 5:** Unused (inputs or I/O's) must be held HIGH or LOW. They may not float.

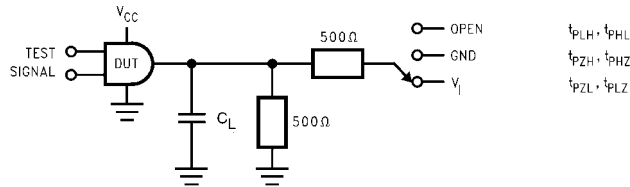
### DC Electrical Characteristics

Symbol	Parameter	Conditions	V <sub>CC</sub> (V)	T <sub>A</sub> = -40°C to +85°C		Units
				Min	Max	
V <sub>IH</sub>	HIGH Level Input Voltage		2.3 – 2.7	1.7		V
			2.7 – 3.6	2.0		
V <sub>IL</sub>	LOW Level Input Voltage		2.3 – 2.7		0.7	V
			2.7 – 3.6		0.8	
V <sub>OH</sub>	HIGH Level Output Voltage	I <sub>OH</sub> = -100 μA	2.3 – 3.6	V <sub>CC</sub> - 0.2		V
		I <sub>OH</sub> = -8 mA	2.3	1.8		
		I <sub>OH</sub> = -12 mA	2.7	2.2		
		I <sub>OH</sub> = -18 mA	3.0	2.4		
		I <sub>OH</sub> = -24 mA	3.0	2.2		
V <sub>OL</sub>	LOW Level Output Voltage	I <sub>OL</sub> = 100 μA	2.3 – 3.6		0.2	V
		I <sub>OL</sub> = 8 mA	2.3		0.6	
		I <sub>OL</sub> = 12 mA	2.7		0.4	
		I <sub>OL</sub> = 16 mA	3.0		0.4	
		I <sub>OL</sub> = 24 mA	3.0		0.55	
I <sub>I</sub>	Input Leakage Current	0 ≤ V <sub>I</sub> ≤ 5.5V	2.3 – 3.6		±5.0	μA
I <sub>OZ</sub>	3-STATE I/O Leakage	0 ≤ V <sub>O</sub> ≤ 5.5V V <sub>I</sub> = V <sub>IH</sub> or V <sub>IL</sub>	2.3 – 3.6		±5.0	μA
I <sub>OFF</sub>	Power-Off Leakage Current	V <sub>I</sub> or V <sub>O</sub> = 5.5V	0		10	μA

74LCX16652

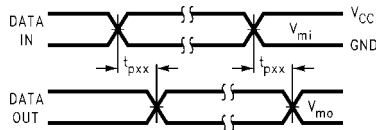
DC Electrical Characteristics (Continued)								
Symbol	Parameter	Conditions	V <sub>CC</sub> (V)	T <sub>A</sub> = -40°C to +85°C		Units		
				Min	Max			
I <sub>CC</sub>	Quiescent Supply Current	V <sub>I</sub> = V <sub>CC</sub> or GND	2.3 – 3.6		20	μA		
		3.6V ≤ V <sub>I</sub> , V <sub>O</sub> ≤ 5.5V (Note 6)	2.3 – 3.6		±20			
ΔI <sub>CC</sub>	Increase in I <sub>CC</sub> per Input	V <sub>IH</sub> = V <sub>CC</sub> - 0.6V	2.3 – 3.6		500	μA		
<b>Note 6:</b> Outputs disabled or 3-STATE only.								
AC Electrical Characteristics								
Symbol	Parameter	T <sub>A</sub> = -40°C to +85°C, R <sub>L</sub> = 500Ω						Units
		V <sub>CC</sub> = 3.3V ± 0.3V		V <sub>CC</sub> = 2.7V		V <sub>CC</sub> = 2.5V ± 0.2V		
		C <sub>L</sub> = 50 pF		C <sub>L</sub> = 50 pF		C <sub>L</sub> = 30 pF		
		Min	Max	Min	Max	Min	Max	
f <sub>MAX</sub>	Maximum Clock Frequency	170					MHz	
t <sub>PHL</sub>	Propagation Delay	1.5	5.7	1.5	6.2	1.5	6.8	ns
t <sub>PLH</sub>	Bus to Bus	1.5	5.7	1.5	6.2	1.5	6.8	
t <sub>PHL</sub>	Propagation Delay	1.5	6.2	1.5	7.0	1.5	7.4	ns
t <sub>PLH</sub>	Clock to Bus	1.5	6.2	1.5	7.0	1.5	7.4	
t <sub>PHL</sub>	Propagation Delay	1.5	6.5	1.5	7.0	1.5	7.8	ns
t <sub>PLH</sub>	Select to Bus	1.5	6.5	1.5	7.0	1.5	7.8	
t <sub>PZL</sub>	Output Enable Time	1.5	7.0	1.5	8.0	1.5	9.1	ns
t <sub>PZH</sub>	Output Disable Time	1.5	7.0	1.5	8.0	1.5	9.1	
t <sub>PLZ</sub>	Output Disable Time	1.5	6.5	1.5	7.0	1.5	7.8	ns
t <sub>PHZ</sub>	Output Enable Time	1.5	6.5	1.5	7.0	1.5	7.8	
t <sub>S</sub>	Setup Time	2.5		2.5		3.0		ns
t <sub>H</sub>	Hold Time	1.5		1.5		2.0		ns
t <sub>W</sub>	Pulse Width	3.0		3.0		3.5		ns
t <sub>OSHL</sub>	Output to Output Skew (Note 7)		1.0					ns
t <sub>OSLH</sub>			1.0					
<b>Note 7:</b> Skew is defined as the absolute value of the difference between the actual propagation delay for any two separate outputs of the same device. The specification applies to any outputs switching in the same direction, either HIGH-to-LOW (t <sub>OSHL</sub> ) or LOW-to-HIGH (t <sub>OSLH</sub> ). Parameter guaranteed by design.								
Dynamic Switching Characteristics								
Symbol	Parameter	Conditions	V <sub>CC</sub> (V)	T <sub>A</sub> = 25°C		Units		
				Typical				
V <sub>OLP</sub>	Quiet Output Dynamic Peak V <sub>OL</sub>	C <sub>L</sub> = 50 pF, V <sub>IH</sub> = 3.3V, V <sub>IL</sub> = 0V	3.3	0.8		V		
		C <sub>L</sub> = 30 pF, V <sub>IH</sub> = 2.5V, V <sub>IL</sub> = 0V	2.5	0.6				
V <sub>OLV</sub>	Quiet Output Dynamic Valley V <sub>OL</sub>	C <sub>L</sub> = 50 pF, V <sub>IH</sub> = 3.3V, V <sub>IL</sub> = 0V	3.3	-0.8		V		
		C <sub>L</sub> = 30 pF, V <sub>IH</sub> = 2.5V, V <sub>IL</sub> = 0V	2.5	-0.6				
Capacitance								
Symbol	Parameter	Conditions	Typical	Units				
C <sub>IN</sub>	Input Capacitance	V <sub>CC</sub> = Open, V <sub>I</sub> = 0V or V <sub>CC</sub>	7	pF				
C <sub>I/O</sub>	Input/Output Capacitance	V <sub>CC</sub> = 3.3V, V <sub>I</sub> = 0V or V <sub>CC</sub>	8	pF				
C <sub>PD</sub>	Power Dissipation Capacitance	V <sub>CC</sub> = 3.3V, V <sub>I</sub> = 0V or V <sub>CC</sub> , f = 10 MHz	20	pF				

**AC LOADING and WAVEFORMS** Generic for LCX Family

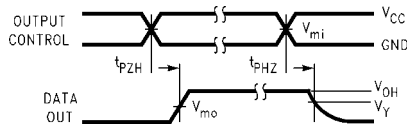


**FIGURE 1. AC Test Circuit** ( $C_L$  includes probe and jig capacitance)

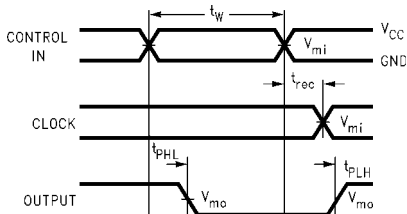
Test	Switch
$t_{PLH}, t_{PHL}$	Open
$t_{PZL}, t_{PLZ}$	6V at $V_{CC} = 3.3 \pm 0.3V$ $V_{CC} \times 2$ at $V_{CC} = 2.5 \pm 0.2V$
$t_{PZH}, t_{PHZ}$	GND



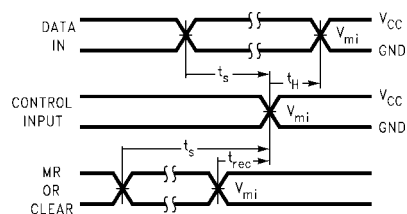
**Waveform for Inverting and Non-Inverting Functions**



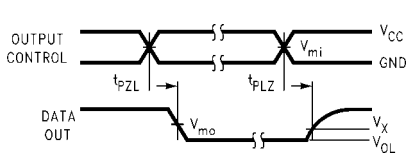
**3-STATE Output High Enable and Disable Times for Logic**



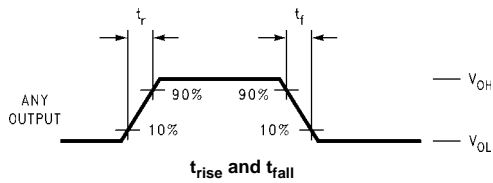
**Propagation Delay, Pulse Width and  $t_{rec}$  Waveforms**



**Setup Time, Hold Time and Recovery Time for Logic**



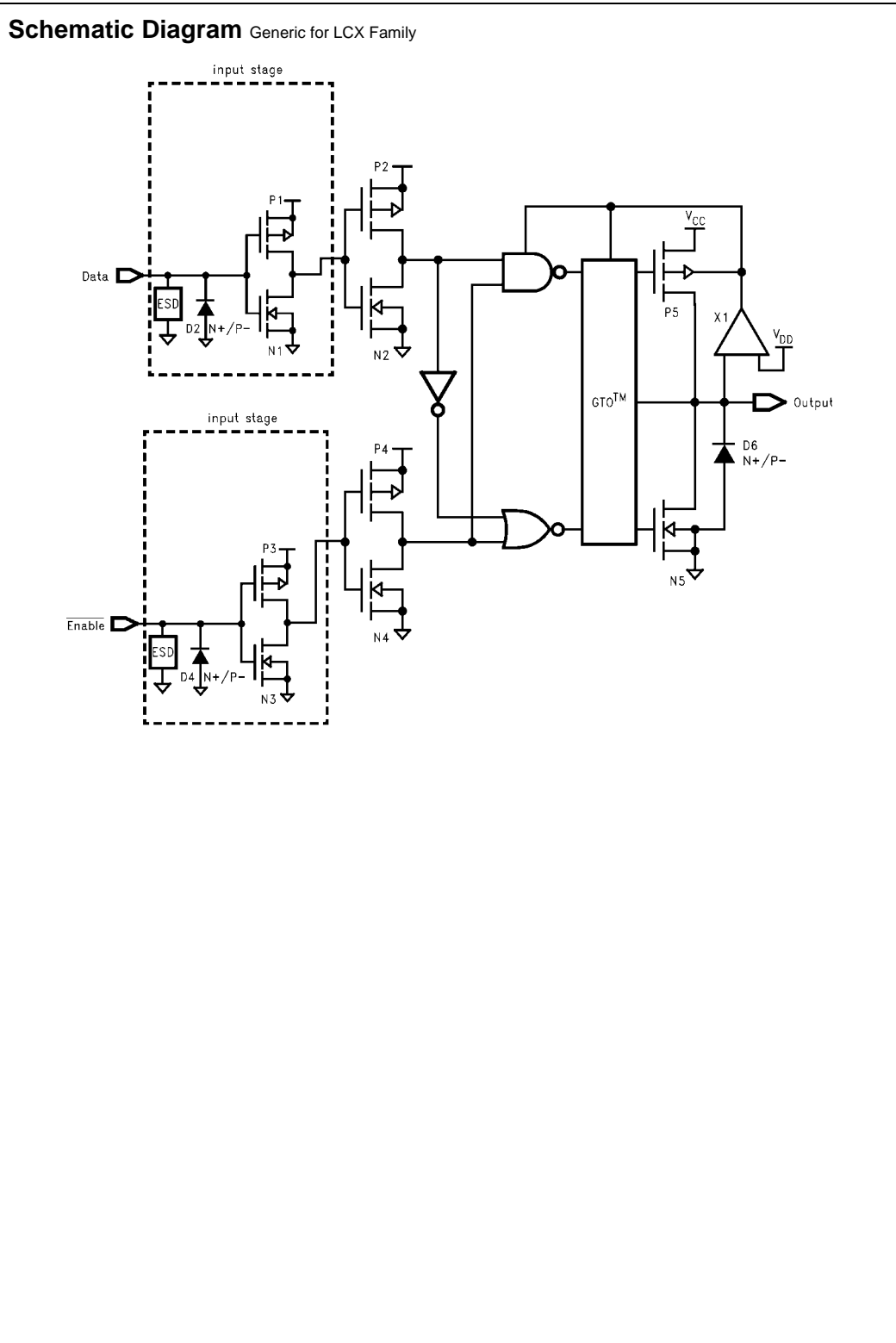
**3-STATE Output Low Enable and Disable Times for Logic**



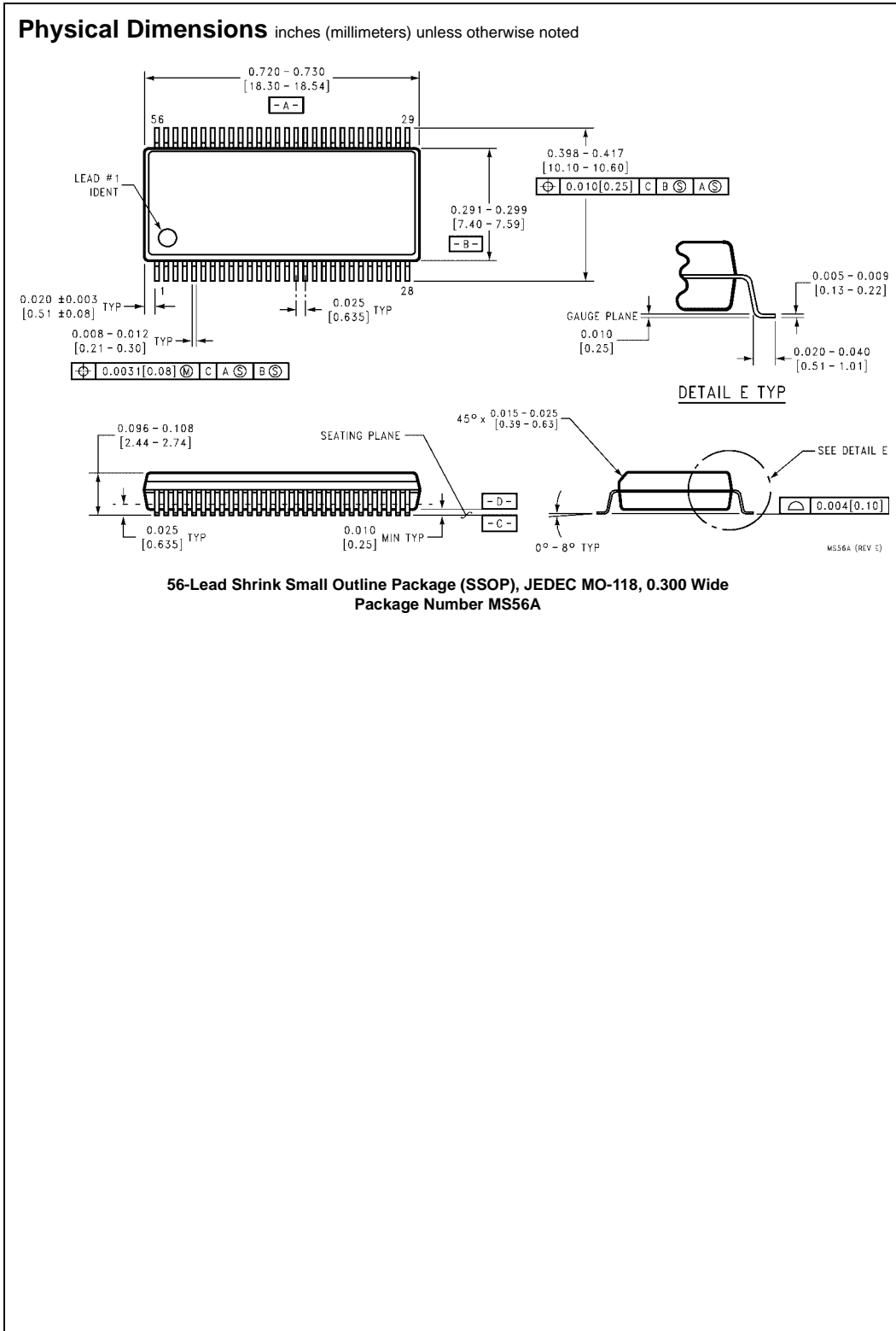
**FIGURE 2. Waveforms**  
(Input Characteristics;  $f = 1MHz, t_R = t_F = 3ns$ )

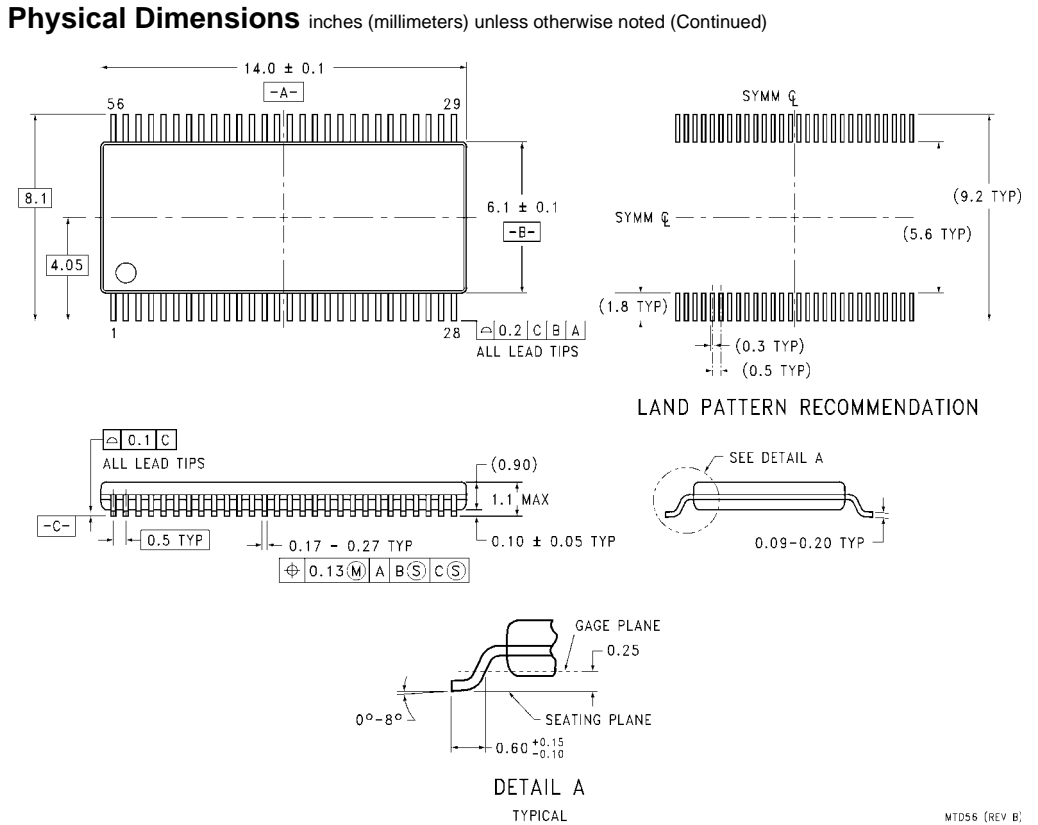
Symbol	$V_{CC}$		
	$3.3V \pm 0.3V$	$2.7V$	$2.5V \pm 0.2V$
$V_{mi}$	1.5V	1.5V	$V_{CC}/2$
$V_{mo}$	1.5V	1.5V	$V_{CC}/2$
$V_x$	$V_{OL} + 0.3V$	$V_{OL} + 0.3V$	$V_{OL} + 0.15V$
$V_y$	$V_{OH} - 0.3V$	$V_{OH} - 0.3V$	$V_{OH} - 0.15V$

74LCX16652









56-Lead Thin Shrink Small Outline Package (TSSOP), JEDEC MO-153, 6.1mm Wide Package Number MTD56

Fairchild does not assume any responsibility for use of any circuitry described, no circuit patent licenses are implied and Fairchild reserves the right at any time without notice to change said circuitry and specifications.

**LIFE SUPPORT POLICY**

FAIRCHILD'S PRODUCTS ARE NOT AUTHORIZED FOR USE AS CRITICAL COMPONENTS IN LIFE SUPPORT DEVICES OR SYSTEMS WITHOUT THE EXPRESS WRITTEN APPROVAL OF THE PRESIDENT OF FAIRCHILD SEMICONDUCTOR CORPORATION. As used herein:

1. Life support devices or systems are devices or systems which, (a) are intended for surgical implant into the body, or (b) support or sustain life, and (c) whose failure to perform when properly used in accordance with instructions for use provided in the labeling, can be reasonably expected to result in a significant injury to the user.
2. A critical component in any component of a life support device or system whose failure to perform can be reasonably expected to cause the failure of the life support device or system, or to affect its safety or effectiveness.

[www.fairchildsemi.com](http://www.fairchildsemi.com)