

N-Channel 200-V (D-S) MOSFET

PRODUCT SUMMARY		
V _{DS} (V)	R _{DS(on)} (Ω)	I _D (A)
200	0.130 at V _{GS} = 10 V	4.1
	0.142 at V _{GS} = 6.0 V	3.9

FEATURES

- Halogen-free According to IEC 61249-2-21 Available
- TrenchFET[®] Power MOSFETs
- New Low Thermal Resistance PowerPAK[®] Package with Low 1.07 mm Profile
- PWM Optimized For Fast Switching



RoHS
 COMPLIANT
 HALOGEN
FREE
 Available

APPLICATIONS

- Primary Side Switch

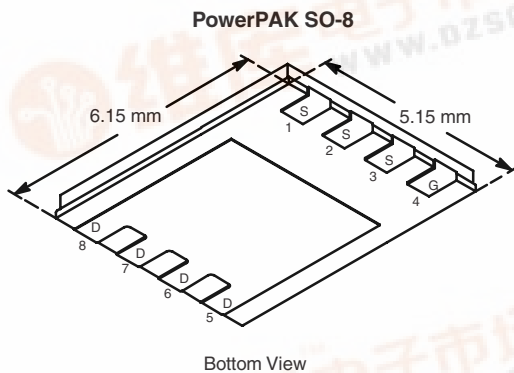

Bottom View

Ordering Information: Si7462DP-T1-E3 (Lead (Pb)-free)
 Si7462DP-T1-GE3 (Lead (Pb)-free and Halogen-free)



N-Channel MOSFET

ABSOLUTE MAXIMUM RATINGS T _A = 25 °C, unless otherwise noted				
Parameter	Symbol	10 s	Steady State	Unit
Drain-Source Voltage	V _{DS}		200	V
Gate-Source Voltage	V _{GS}		± 20	
Continuous Drain Current (T _J = 150 °C) ^a	I _D	T _A = 25 °C	4.1	A
		T _A = 85 °C	3.0	
Pulsed Drain Current	I _{DM}		12	A
Avalanche Current	I _{AS}		6	
Single Avalanche Energy (Duty Cycle ≤ 1 %)	E _{AS}		1.8	mJ
Continuous Source Current (Diode Conduction) ^a	I _S		4.0	A
Maximum Power Dissipation ^a	P _D	T _A = 25 °C	4.8	
		T _A = 85 °C	2.6	
Operating Junction and Storage Temperature Range	T _J , T _{stg}		- 55 to 150	°C
Soldering Recommendations (Peak Temperature) ^{b,c}			260	

THERMAL RESISTANCE RATINGS					
Parameter	Symbol	Typical	Maximum	Unit	
Maximum Junction-to-Ambient ^a	R _{thJA}	t ≤ 10 s	21	26	°C/W
		Steady State	55	65	
Maximum Junction-to-Case (Drain)	R _{thJC}	1.7	2.1		

Notes:

a. Surface Mounted on 1" x 1" FR4 board.

b. See Solder Profile (www.vishay.com/ppg?7325Z). The PowerPAK SO-8 is a leadless package. The end of the lead terminal is exposed copper (not plated) as a result of the singulation process in manufacturing. A solder fillet at the exposed copper tip cannot be guaranteed and is not required to ensure adequate bottom side solder interconnection.

c. Rework Conditions: manual soldering with a soldering iron is not recommended for leadless components.



SPECIFICATIONS $T_J = 25^\circ\text{C}$, unless otherwise noted						
Parameter	Symbol	Test Condition	Min.	Typ.	Max.	Unit
Static						
Gate Threshold Voltage	$V_{GS(th)}$	$V_{DS} = V_{GS}, I_D = 250\ \mu\text{A}$	2		4	V
Gate-Body Leakage	I_{GSS}	$V_{DS} = 0\ \text{V}, V_{GS} = \pm 20\ \text{V}$			± 100	nA
Zero Gate Voltage Drain Current	I_{DSS}	$V_{DS} = 200\ \text{V}, V_{GS} = 0\ \text{V}$			1	μA
		$V_{DS} = 200\ \text{V}, V_{GS} = 0\ \text{V}, T_J = 85^\circ\text{C}$			20	
On-State Drain Current ^a	$I_{D(on)}$	$V_{DS} \geq 5\ \text{V}, V_{GS} = 10\ \text{V}$	12			A
Drain-Source On-State Resistance ^a	$R_{DS(on)}$	$V_{GS} = 10\ \text{V}, I_D = 4.1\ \text{A}$		0.110	0.130	Ω
		$V_{GS} = 6.0\ \text{V}, I_D = 3.9\ \text{A}$		0.120	0.142	
Forward Transconductance ^a	g_{fs}	$V_{DS} = 15\ \text{V}, I_D = 4.1\ \text{A}$		13		S
Diode Forward Voltage ^a	V_{SD}	$I_S = 4\ \text{A}, V_{GS} = 0\ \text{V}$		0.8	1.2	V
Dynamic^b						
Total Gate Charge	Q_g	$V_{DS} = 100\ \text{V}, V_{GS} = 10\ \text{V}, I_D = 4.1\ \text{A}$		20	30	nC
Gate-Source Charge	Q_{gs}		4.5			
Gate-Drain Charge	Q_{gd}		6.5			
Gate Resistance	R_g		2			Ω
Turn-On Delay Time	$t_{d(on)}$	$V_{DD} = 100\ \text{V}, R_L = 100\ \Omega$ $I_D \cong 1\ \text{A}, V_{GEN} = 10\ \text{V}, R_g = 6\ \Omega$		15	25	ns
Rise Time	t_r		15	25		
Turn-Off Delay Time	$t_{d(off)}$		40	60		
Fall Time	t_f		20	30		
Source-Drain Reverse Recovery Time	t_{rr}	$I_F = 4\ \text{A}, di/dt = 100\ \text{A}/\mu\text{s}$		70	110	

Notes:

- a. Pulse test; pulse width $\leq 300\ \mu\text{s}$, duty cycle $\leq 2\%$.
- b. Guaranteed by design, not subject to production testing.

Stresses beyond those listed under "Absolute Maximum Ratings" may cause permanent damage to the device. These are stress ratings only, and functional operation of the device at these or any other conditions beyond those indicated in the operational sections of the specifications is not implied. Exposure to absolute maximum rating conditions for extended periods may affect device reliability.

TYPICAL CHARACTERISTICS 25°C , unless otherwise noted

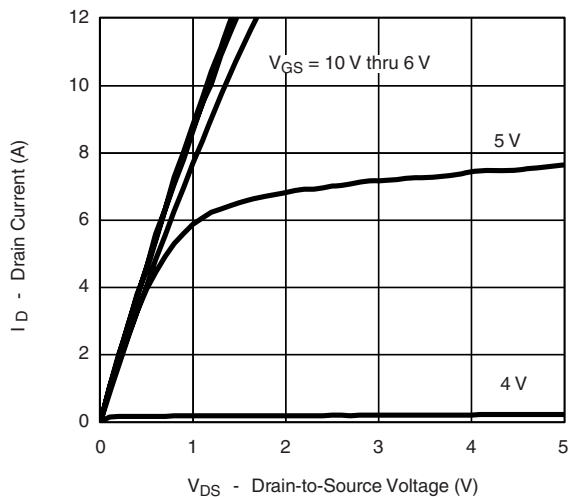

Output Characteristics

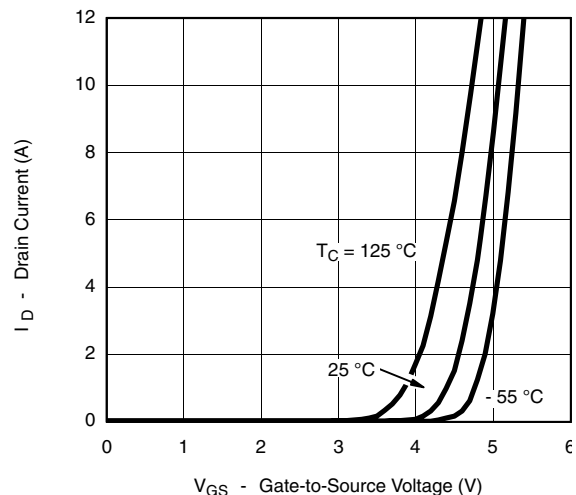

Transfer Characteristics

TYPICAL CHARACTERISTICS 25 °C, unless otherwise noted

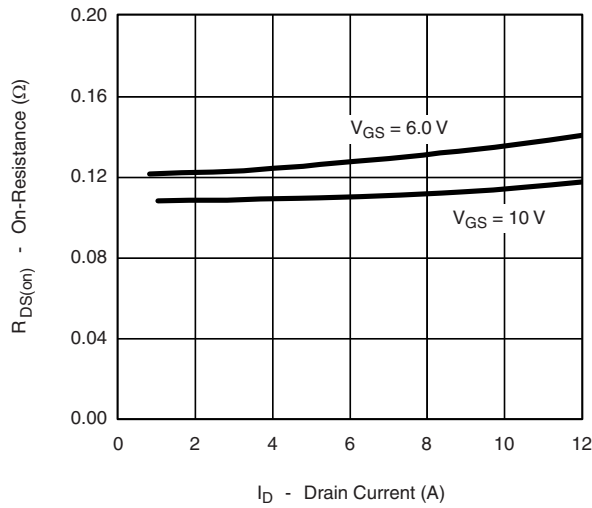

On-Resistance vs. Drain Current

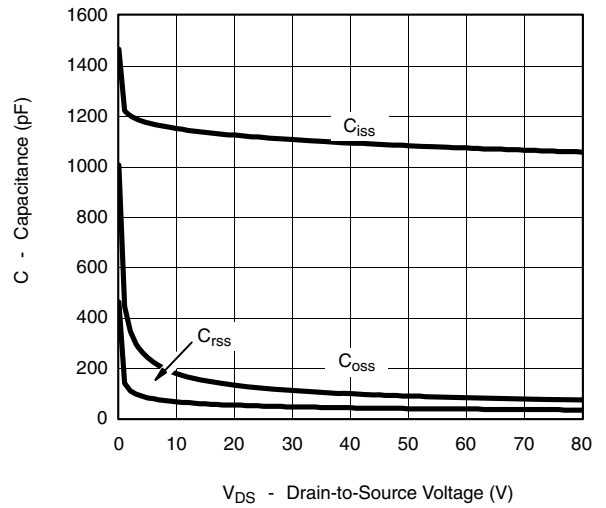

Capacitance

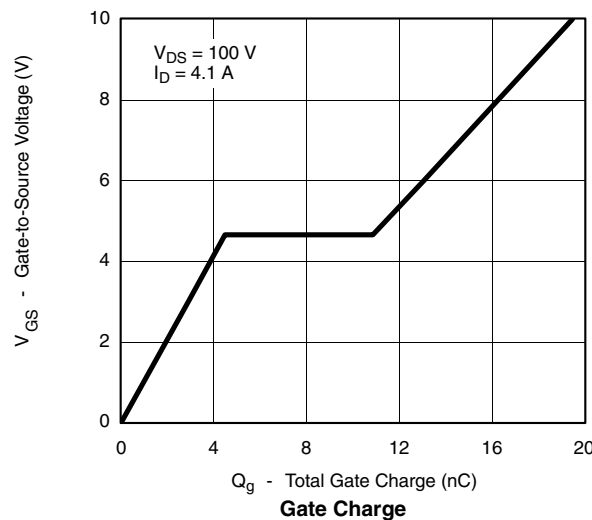

Gate Charge

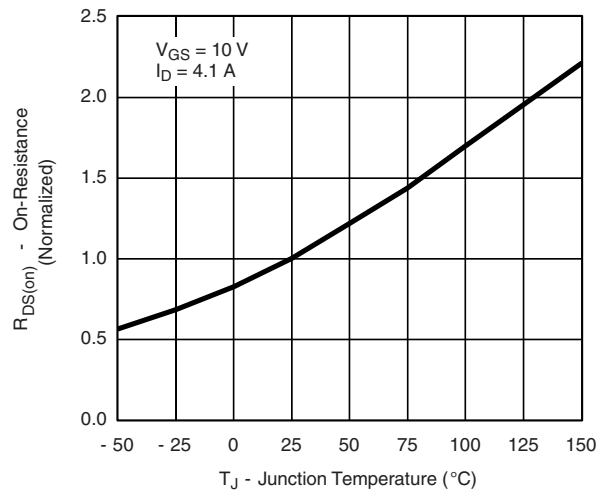

On-Resistance vs. Junction Temperature

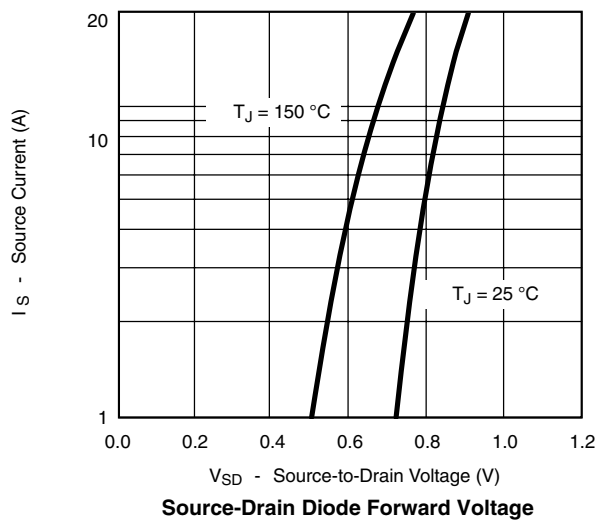

Source-Drain Diode Forward Voltage

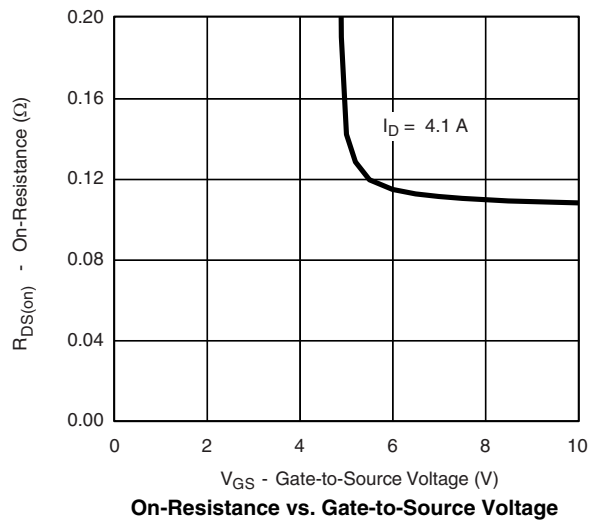

On-Resistance vs. Gate-to-Source Voltage

TYPICAL CHARACTERISTICS 25 °C, unless otherwise noted

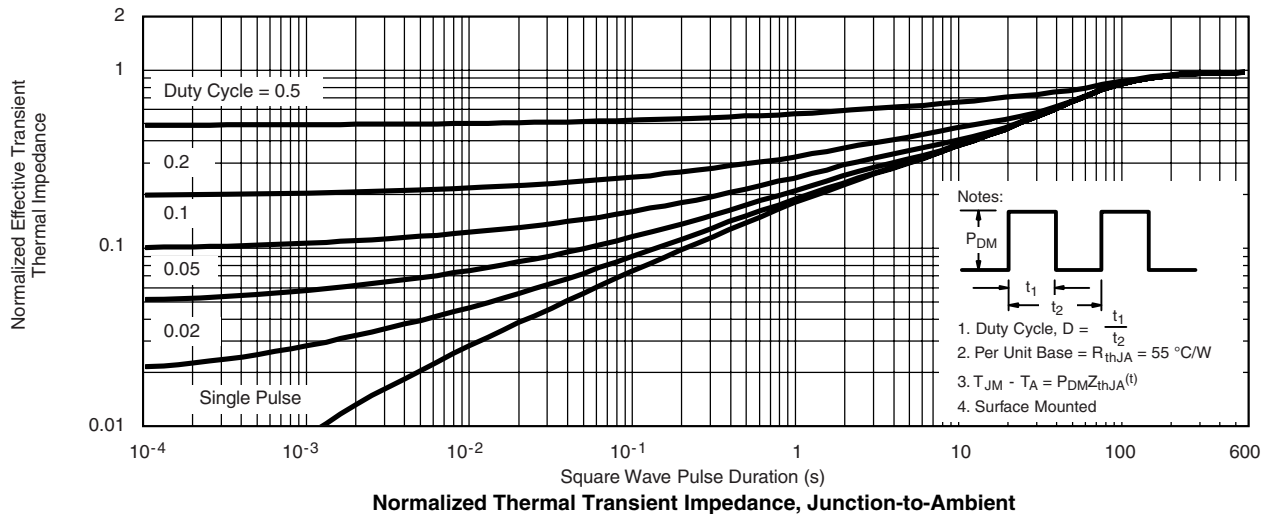
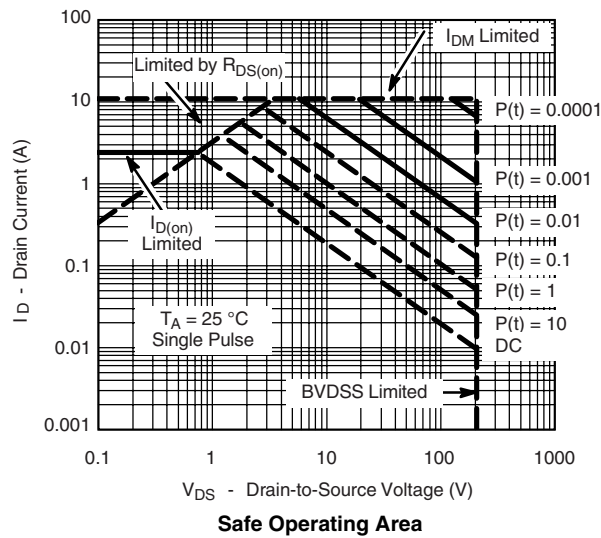
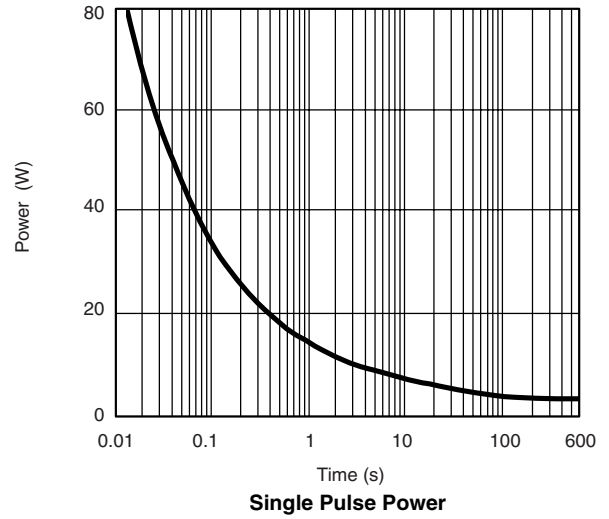
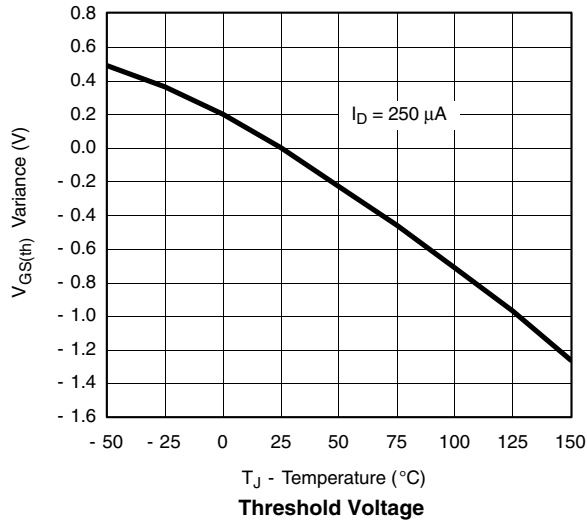

TYPICAL CHARACTERISTICS 25 °C, unless otherwise noted

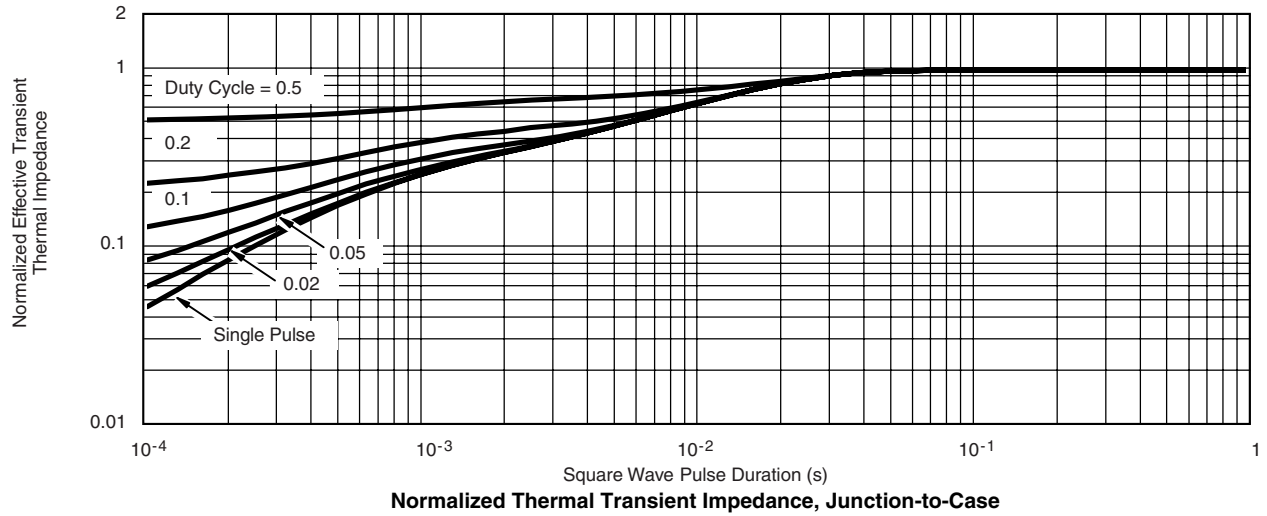

Vishay Siliconix maintains worldwide manufacturing capability. Products may be manufactured at one of several qualified locations. Reliability data for Silicon Technology and Package Reliability represent a composite of all qualified locations. For related documents such as package/tape drawings, part marking, and reliability data, see www.vishay.com/ppg?72136.

Disclaimer

All product specifications and data are subject to change without notice.

Vishay Intertechnology, Inc., its affiliates, agents, and employees, and all persons acting on its or their behalf (collectively, "Vishay"), disclaim any and all liability for any errors, inaccuracies or incompleteness contained herein or in any other disclosure relating to any product.

Vishay disclaims any and all liability arising out of the use or application of any product described herein or of any information provided herein to the maximum extent permitted by law. The product specifications do not expand or otherwise modify Vishay's terms and conditions of purchase, including but not limited to the warranty expressed therein, which apply to these products.

No license, express or implied, by estoppel or otherwise, to any intellectual property rights is granted by this document or by any conduct of Vishay.

The products shown herein are not designed for use in medical, life-saving, or life-sustaining applications unless otherwise expressly indicated. Customers using or selling Vishay products not expressly indicated for use in such applications do so entirely at their own risk and agree to fully indemnify Vishay for any damages arising or resulting from such use or sale. Please contact authorized Vishay personnel to obtain written terms and conditions regarding products designed for such applications.

Product names and markings noted herein may be trademarks of their respective owners.