

Power MOSFET

3 Amps, 60 Volts

N-Channel SO-8, Dual

Designed for low voltage, high speed switching applications in power supplies, converters and power motor controls, these devices are particularly well suited for bridge circuits where diode speed and commutating safe operating areas are critical and offer additional safety margin against unexpected voltage transients.

Features

- On-resistance Area Product about One-half that of Standard MOSFETs with New Low Voltage, Low $R_{DS(on)}$ Technology
- Faster Switching than E-FET™ Predecessors
- Avalanche Energy Specified
- I_{DSS} and $V_{DS(on)}$ Specified at Elevated Temperature
- Static Parameters are the Same for both TMOS V and TMOS E-FET
- Miniature SO-8 Surface Mount Package – Saves Board Space
- Mounting Information for SO-8 Package Provided

MAXIMUM RATINGS ($T_J = 25^\circ\text{C}$ unless otherwise noted)

Rating	Symbol	Value	Unit
Drain-to-Source Voltage	V_{DSS}	60	Vdc
Drain-to-Gate Voltage, ($R_{GS} = 1\text{ M}\Omega$)	V_{DGR}	60	Vdc
Gate-to-Source Voltage – Continuous	V_{GS}	± 15	Vdc
Drain Current – Continuous @ $T_A = 25^\circ\text{C}$	I_D	3.3	Adc
	I_D	0.7	
	I_{DM}	10	Apk
Total Power Dissipation @ $T_A = 25^\circ\text{C}$ (Note 1)	P_D	2.0	W
	Operating and Storage Temperature Range	T_J, T_{stg}	-55 to 150
Single Pulse Drain-to-Source Avalanche Energy – Starting $T_J = 25^\circ\text{C}$ ($V_{DD} = 25\text{ Vdc}$, $V_{GS} = 5.0\text{ Vdc}$, Peak $I_L = 3.3\text{ Apk}$, $L = 10\text{ mH}$, $R_G = 25\ \Omega$)	E_{AS}	54	mJ
Thermal Resistance, Junction to Ambient (Note 1)	$R_{\theta JA}$	62.5	$^\circ\text{C/W}$
Maximum Lead Temperature for Soldering Purposes, 0.0625" from case for 10 seconds	T_L	260	$^\circ\text{C}$

1 Mounted on G10/FR4 glass epoxy board using minimum recommended footprint.



ON Semiconductor®

<http://onsemi.com>

V_{DSS}	$R_{DS(on)}$ TYP	I_D MAX
60 V	130 m Ω	3.0 A

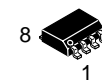
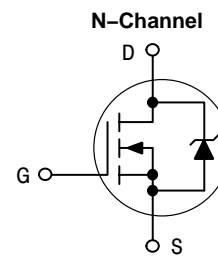

SO-8
CASE 751
STYLE 11

MARKING DIAGRAM

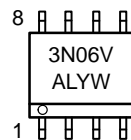

A = Assembly Location
L = Wafer Lot
Y = Year
W = Work Week

PIN ASSIGNMENT

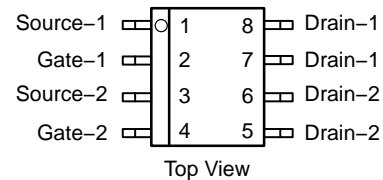

ORDERING INFORMATION

Device	Package	Shipping†
MMDF3N06VLR2	SO-8	2500 Tape & Reel

†For information on tape and reel specifications, including part orientation and tape sizes, please refer to our Tape and Reel Packaging Specification Brochure, BRD8011/D.

MMDF3N06VL

ELECTRICAL CHARACTERISTICS (T_A = 25°C unless otherwise noted)

Characteristic	Symbol	Min	Typ	Max	Unit
----------------	--------	-----	-----	-----	------

OFF CHARACTERISTICS

Drain-to-Source Breakdown Voltage (V _{GS} = 0 Vdc, I _D = 0.25 mAdc) Temperature Coefficient (Positive)	V _{(BR)DSS}	60 -	- 66	- -	Vdc mV/°C
Zero Gate Voltage Drain Current (V _{DS} = 60 Vdc, V _{GS} = 0 Vdc) (V _{DS} = 60 Vdc, V _{GS} = 0 Vdc, T _J = 150°C)	I _{DSS}	- -	- -	10 100	μAdc
Gate-Body Leakage Current (V _{GS} = ± 15 Vdc, V _{DS} = 0 Vdc)	I _{GSS}	-	-	100	nAdc

ON CHARACTERISTICS (Note 1)

Gate Threshold Voltage (V _{DS} = V _{GS} , I _D = 250 μAdc) Threshold Temperature Coefficient (Negative)	V _{GS(th)}	1.0 -	1.5 3.0	2.0 -	Vdc mV/°C
Static Drain-to-Source On-Resistance (V _{GS} = 5.0 Vdc, I _D = 3.3 Adc)	R _{DS(on)}	-	0.12	0.13	Ω
Drain-to-Source On-Voltage (V _{GS} = 5.0 Vdc, I _D = 3.3 Adc) (V _{GS} = 5.0 Vdc, I _D = 1.65 Adc, T _J = 150°C)	V _{DS(on)}	- -	- -	0.5 0.4	Vdc
Forward Transconductance (V _{DS} = 15 Vdc, I _D = 1.65 Adc)	g _{FS}	1.0	3.0	-	Mhos

DYNAMIC CHARACTERISTICS

Input Capacitance	(V _{DS} = 25 Vdc, V _{GS} = 0 Vdc, f = 1.0 MHz)	C _{ISS}	-	340	480	pF
Output Capacitance		C _{OSS}	-	110	150	
Transfer Capacitance		C _{RSS}	-	27	50	

SWITCHING CHARACTERISTICS (Note 2)

Turn-On Delay Time	(V _{DD} = 30 Vdc, I _D = 3.3 Adc, V _{GS} = 5.0 Vdc, R _G = 9.1 Ω)	t _{d(on)}	-	10	20	ns
Rise Time		t _r	-	30	60	
Turn-Off Delay Time		t _{d(off)}	-	32	60	
Fall Time		t _f	-	28	60	
Gate Charge	(V _{DS} = 48 Vdc, I _D = 3.3 Adc, V _{GS} = 5.0 Vdc)	Q _T	-	9.0	20	nC
		Q ₁	-	1.5	-	
		Q ₂	-	4.3	-	
		Q ₃	-	3.5	-	

SOURCE-DRAIN DIODE CHARACTERISTICS

Forward On-Voltage (Note 1)	(I _S = 3.3 Adc, V _{GS} = 0 Vdc) (I _S = 3.3 Adc, V _{GS} = 0 Vdc, T _J = 150°C)	V _{SD}	- -	0.84 0.67	1.2 -	Vdc
Reverse Recovery Time	(I _S = 3.3 Adc, V _{GS} = 0 Vdc, di _S /dt = 100 A/μs)	t _{rr}	-	58	-	ns
		t _a	-	38	-	
		t _b	-	20	-	
Reverse Recovery Storage Charge		Q _{RR}	-	0.11	-	μC

1. Pulse Test: Pulse Width ≤ 300 μs, Duty Cycle ≤ 2%.
2. Switching characteristics are independent of operating junction temperature.

MMDF3N06VL

[查询"MMDF3N06VLR2"供应商](#)

PACKAGE DIMENSIONS

SO-8
CASE 751-07
ISSUE AB

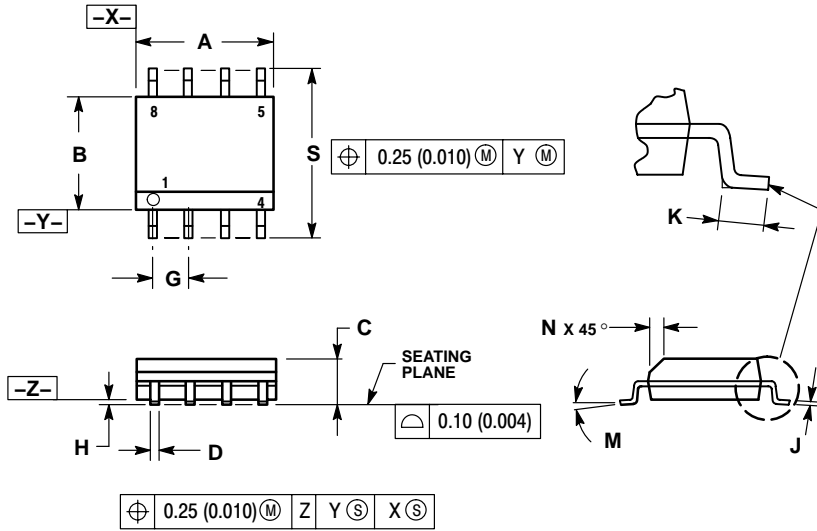

NOTES:

1. DIMENSIONING AND TOLERANCING PER ANSI Y14.5M, 1982.
2. CONTROLLING DIMENSION: MILLIMETER.
3. DIMENSION A AND B DO NOT INCLUDE MOLD PROTRUSION.
4. MAXIMUM MOLD PROTRUSION 0.15 (0.006) PER SIDE.
5. DIMENSION D DOES NOT INCLUDE DAMBAR PROTRUSION. ALLOWABLE DAMBAR PROTRUSION SHALL BE 0.127 (0.005) TOTAL IN EXCESS OF THE D DIMENSION AT MAXIMUM MATERIAL CONDITION.
6. 751-01 THRU 751-06 ARE OBSOLETE. NEW STANDARD IS 751-07.

DIM	MILLIMETERS		INCHES	
	MIN	MAX	MIN	MAX
A	4.80	5.00	0.189	0.197
B	3.80	4.00	0.150	0.157
C	1.35	1.75	0.053	0.069
D	0.33	0.51	0.013	0.020
G	1.27 BSC		0.050 BSC	
H	0.10	0.25	0.004	0.010
J	0.19	0.25	0.007	0.010
K	0.40	1.27	0.016	0.050
M	0°	8°	0°	8°
N	0.25	0.50	0.010	0.020
S	5.80	6.20	0.228	0.244

STYLE 11:

- PIN 1. SOURCE 1
- 2. GATE 1
- 3. SOURCE 2
- 4. GATE 2
- 5. DRAIN 2
- 6. DRAIN 2
- 7. DRAIN 1
- 8. DRAIN 1

SOLDERING FOOTPRINT*

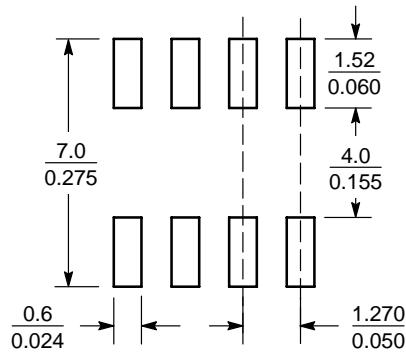

SCALE 6:1 ($\frac{\text{mm}}{\text{inches}}$)

*For additional information on our Pb-Free strategy and soldering details, please download the ON Semiconductor Soldering and Mounting Techniques Reference Manual, SOLDERRM/D.

MMDF3N06VL

[查询"MMDF3N06VLR2"供应商](#)

E-FET is a trademark of Semiconductor Components Industries, LLC (SCILLC).

ON Semiconductor and  are registered trademarks of Semiconductor Components Industries, LLC (SCILLC). SCILLC reserves the right to make changes without further notice to any products herein. SCILLC makes no warranty, representation or guarantee regarding the suitability of its products for any particular purpose, nor does SCILLC assume any liability arising out of the application or use of any product or circuit, and specifically disclaims any and all liability, including without limitation special, consequential or incidental damages. "Typical" parameters which may be provided in SCILLC data sheets and/or specifications can and do vary in different applications and actual performance may vary over time. All operating parameters, including "Typicals" must be validated for each customer application by customer's technical experts. SCILLC does not convey any license under its patent rights nor the rights of others. SCILLC products are not designed, intended, or authorized for use as components in systems intended for surgical implant into the body, or other applications intended to support or sustain life, or for any other application in which the failure of the SCILLC product could create a situation where personal injury or death may occur. Should Buyer purchase or use SCILLC products for any such unintended or unauthorized application, Buyer shall indemnify and hold SCILLC and its officers, employees, subsidiaries, affiliates, and distributors harmless against all claims, costs, damages, and expenses, and reasonable attorney fees arising out of, directly or indirectly, any claim of personal injury or death associated with such unintended or unauthorized use, even if such claim alleges that SCILLC was negligent regarding the design or manufacture of the part. SCILLC is an Equal Opportunity/Affirmative Action Employer. This literature is subject to all applicable copyright laws and is not for resale in any manner.

PUBLICATION ORDERING INFORMATION

LITERATURE FULFILLMENT:

Literature Distribution Center for ON Semiconductor
P.O. Box 5163, Denver, Colorado 80217 USA

Phone: 303-675-2175 or 800-344-3860 Toll Free USA/Canada

Fax: 303-675-2176 or 800-344-3867 Toll Free USA/Canada

Email: orderlit@onsemi.com

N. American Technical Support: 800-282-9855 Toll Free
USA/Canada

Japan: ON Semiconductor, Japan Customer Focus Center

2-9-1 Kamimeguro, Meguro-ku, Tokyo, Japan 153-0051

Phone: 81-3-5773-3850

ON Semiconductor Website: <http://onsemi.com>

Order Literature: <http://www.onsemi.com/litorder>

For additional information, please contact your
local Sales Representative.

MMDF3N06VL/D