

# LM7332 Dual Rail-to-Rail Input/Output 30V, Wide Voltage Range, High Output Operational Amplifier

## General Description

The LM7332 is a dual rail-to-rail input and output amplifier with a wide operating temperature range ( $-40^{\circ}\text{C}$  to  $+125^{\circ}\text{C}$ ) which meets the needs of automotive, industrial and power supply applications. The LM7332 has the output current of 100 mA which is higher than that of most monolithic op amps. Circuit designs with high output current requirements often need to use discrete transistors because many op amps have low current output. The LM7332 has enough current output to drive many loads directly, saving the cost and space of the discrete transistors.

The exceptionally wide operating supply voltage range of 2.5V to 32V alleviates any concerns over functionality under extreme conditions and offers flexibility of use in a multitude of applications. Most of this device's parameters are insensitive to power supply variations; this design enhancement is another step in simplifying usage. Greater than rail-to-rail input common mode voltage range allows operation in many applications, including high side and low side sensing, without exceeding the input range.

The LM7332 can drive unlimited capacitive loads without oscillations.

The LM7332 is offered in the 8-pin MSOP and SOIC packages.

## Features

( $V_S = \pm 15\text{V}$ ,  $T_A = 25^{\circ}\text{C}$ , typical values unless specified.)

- Wide supply voltage range 2.5V to 32V
- Wide input common mode voltage 0.3V beyond rails
- Output short circuit current  $>100$  mA
- High output current (1V from rails)  $\pm 70$  mA
- GBWP 21 MHz
- Slew rate 15.2 V/ $\mu\text{s}$
- Capacitive load tolerance Unlimited
- Total supply current 2.0 mA
- Temperature range  $-40^{\circ}\text{C}$  to  $+125^{\circ}\text{C}$
- Tested at  $-40^{\circ}\text{C}$ ,  $+125^{\circ}\text{C}$ , and  $25^{\circ}\text{C}$  at 5V,  $\pm 5\text{V}$ ,  $\pm 15\text{V}$

## Applications

- MOSFET and power transistor driver
- Replaces discrete transistors in high current output circuits
- Instrumentation 4-20 mA current loops
- Analog data transmission
- Multiple voltage power supplies and battery chargers
- High and low side current sensing
- Bridge and sensor driving
- Digital to analog converter output

## Key Graphs

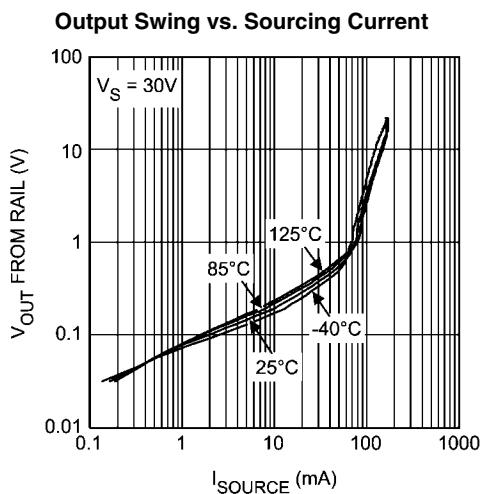

**Large Signal Step Response for Various Capacitive Loads**

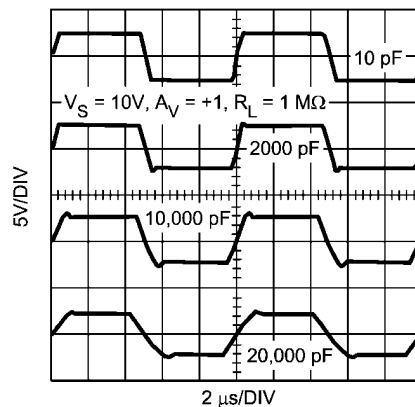

**Absolute Maximum Ratings** (Note 1)

查询"LM7332MM"供应商

If Military/Aerospace specified devices are required, please contact the National Semiconductor Sales Office/Distributors for availability and specifications.

|                                      |                        |
|--------------------------------------|------------------------|
| ESD Tolerance (Note 2)               |                        |
| Human Body Model                     | 2 kV                   |
| Machine Model                        | 200V                   |
| $V_{IN}$ Differential                | $\pm 10V$              |
| Output Short Circuit Duration        | (Notes 3, 9)           |
| Supply Voltage ( $V_S = V^+ - V^-$ ) | 35V                    |
| Voltage at Input/Output pins         | $V^+ +0.3V, V^- -0.3V$ |

Storage Temperature Range  $-65^\circ\text{C}$  to  $+150^\circ\text{C}$

|                                  |                      |
|----------------------------------|----------------------|
| Junction Temperature (Note 4)    | $+150^\circ\text{C}$ |
| Soldering Information:           |                      |
| Infrared or Convection (20 sec.) | $235^\circ\text{C}$  |
| Wave Soldering (10 sec.)         | $260^\circ\text{C}$  |

**Operating Ratings**

|  |   |
|--|---|
| Supply Voltage ( $V_S = V^+ - V^-$ )                 | 2.5V to 32V                                 |
| Temperature Range (Note 4)                           | $-40^\circ\text{C}$ to $+125^\circ\text{C}$ |
| Package Thermal Resistance, $\theta_{JA}$ , (Note 4) |   |
| 8-Pin MSOP   | $235^\circ\text{C/W}$                       |
| 8-Pin SOIC   | $165^\circ\text{C/W}$                       |

**5V Electrical Characteristics** (Note 5)

Unless otherwise specified, all limits are guaranteed for  $T_A = 25^\circ\text{C}$ ,  $V^+ = 5V$ ,  $V^- = 0V$ ,  $V_{CM} = 0.5V$ ,  $V_O = 2.5V$ , and  $R_L > 1\text{ M}\Omega$  to 2.5V. **Boldface** limits apply at the temperature extremes.

| Symbol      | Parameter                                 | Condition  | Min<br>(Note 7)     | Typ<br>(Note 6) | Max<br>(Note 7)     | Units                        |
|-------------|---|--|---------------------|-----------------|---------------------|------------------------------|
| $V_{OS}$    | Input Offset Voltage                      | $V_{CM} = 0.5V$ and $V_{CM} = 4.5V$                            | -4<br><b>-5</b>     | $\pm 1.6$       | +4<br><b>+5</b>     | mV                           |
| TC $V_{OS}$ | Input Offset Voltage<br>Temperature Drift | $V_{CM} = 0.5V$ and $V_{CM} = 4.5V$<br>(Note 10)               |                     | $\pm 2$         |                     | $\mu\text{V}/^\circ\text{C}$ |
| $I_B$       | Input Bias Current                        | (Note 11)  | -2.0<br><b>-2.5</b> | $\pm 1.0$       | +2.0<br><b>+2.5</b> | $\mu\text{A}$                |
| $I_{OS}$    | Input Offset Current                      |  |                     | 20              | 250<br><b>300</b>   | nA                           |
| CMRR        | Common Mode Rejection Ratio               | $0V \leq V_{CM} \leq 3V$                                       | 67<br><b>65</b>     | 80              |                     | dB                           |
|             |   | $0V \leq V_{CM} \leq 5V$                                       | 62<br><b>60</b>     | 70              |                     |                              |
| PSRR        | Power Supply Rejection Ratio              | $5V \leq V^+ \leq 30V$   | 78<br><b>74</b>     | 100             |                     | dB                           |
| CMVR        | Input Common Mode Voltage<br>Range        | CMRR > 50 dB   |                     | -0.3            | -0.1<br><b>0.0</b>  | V                            |
|             |   |  | 5.1<br><b>5.0</b>   | 5.3             |                     |                              |
| $A_{VOL}$   | Large Signal Voltage Gain                 | $0.5V \leq V_O \leq 4.5V$<br>$R_L = 10\text{ k}\Omega$ to 2.5V | 70<br><b>65</b>     | 77              |                     | dB                           |
| $V_O$       | Output Swing<br>High                      | $R_L = 10\text{ k}\Omega$ to 2.5V<br>$V_{ID} = 100\text{ mV}$  |                     | 60              | 150<br><b>200</b>   | mV from<br>either rail       |
|             |   | $R_L = 2\text{ k}\Omega$ to 2.5V<br>$V_{ID} = 100\text{ mV}$   |                     | 100             | 300<br><b>350</b>   |                              |
|             | Output Swing<br>Low                       | $R_L = 10\text{ k}\Omega$ to 2.5V<br>$V_{ID} = -100\text{ mV}$ |                     | 5               | 150<br><b>200</b>   |                              |
|             |   | $R_L = 2\text{ k}\Omega$ to 2.5V<br>$V_{ID} = -100\text{ mV}$  |                     | 20              | 300<br><b>350</b>   |                              |
| $I_{SC}$    | Output Short Circuit Current              | Sourcing from $V^+$ , $V_{ID} = 200\text{ mV}$<br>(Note 9)     | 60                  | 90              |                     | mA                           |
|             |   | Sinking to $V^-$ , $V_{ID} = -200\text{ mV}$<br>(Note 9)       | 60                  | 90              |                     |                              |
| $I_{OUT}$   | Output Current                            | $V_{ID} = \pm 200\text{ mV}$ , $V_O = 1V$ from rails           |                     | $\pm 55$        |                     | mA                           |

| Symbol  | Parameter                           | Condition  | Min<br>(Note 7) | Typ<br>(Note 6) | Max<br>(Note 7)   | Units           |
|---------|-------------------------------------|--|-----------------|-----------------|-------------------|-----------------|
| $I_S$   | Total Supply Current                | No Load, $V_{CM} = 0.5V$   |                 | 1.5             | 2.3<br><b>2.6</b> | mA              |
| SR      | Slew Rate (Note 8)                  | $A_V = +1$ , $V_I = 5V$ Step, $R_L = 1 M\Omega$ ,<br>$C_L = 10 pF$   |                 | 12              |                   | V/ $\mu s$      |
| $f_u$   | Unity Gain Frequency                | $R_L = 10 M\Omega$ , $C_L = 20 pF$                                   |                 | 7.5             |                   | MHz             |
| GBWP    | Gain Bandwidth Product              | $f = 50 kHz$   |                 | 19.3            |                   | MHz             |
| $e_n$   | Input Referred Voltage Noise        | $f = 2 kHz$  |                 | 14.8            |                   | nV/ $\sqrt{Hz}$ |
| $i_n$   | Input Referred Current Noise        | $f = 2 kHz$  |                 | 1.35            |                   | pA/ $\sqrt{Hz}$ |
| THD+N   | Total Harmonic Distortion<br>+Noise | $A_V = +2$ , $R_L = 100 k\Omega$ , $f = 1 kHz$ ,<br>$V_O = 4 V_{PP}$ |                 | -84             |                   | dB              |
| CT Rej. | Crosstalk Rejection                 | $f = 3 MHz$ , Driver $R_L = 10 k\Omega$                              |                 | 68              |                   | dB              |

### $\pm 5V$ Electrical Characteristics (Note 5)

Unless otherwise specified, all limits are guaranteed for  $T_A = 25^\circ C$ ,  $V^+ = +5V$ ,  $V^- = -5V$ ,  $V_{CM} = 0V$ ,  $V_O = 0V$ , and  $R_L > 1 M\Omega$  to  $0V$ . **Boldface** limits apply at the temperature extremes.

| Symbol      | Parameter                                 | Condition  | Min<br>(Note 7)     | Typ<br>(Note 6) | Max<br>(Note 7)     | Units                  |
|-------------|---|--|---------------------|-----------------|---------------------|------------------------|
| $V_{OS}$    | Input Offset Voltage                      | $V_{CM} = -4.5V$ and $V_{CM} = 4.5V$                 | -4<br><b>-5</b>     | $\pm 1.6$       | +4<br><b>+5</b>     | mV                     |
| TC $V_{OS}$ | Input Offset Voltage<br>Temperature Drift | $V_{CM} = -4.5V$ and $V_{CM} = 4.5V$<br>(Note 10)    |                     | $\pm 2$         |                     | $\mu V/^\circ C$       |
| $I_B$       | Input Bias Current                        | (Note 11)  | -2.0<br><b>-2.5</b> | $\pm 1.0$       | +2.0<br><b>+2.5</b> | $\mu A$                |
| $I_{OS}$    | Input Offset Current                      |  |                     | 20              | 250<br><b>300</b>   | nA                     |
| CMRR        | Common Mode Rejection Ratio               | $-5V \leq V_{CM} \leq 3V$                            | 74<br><b>75</b>     | 88              |                     | dB                     |
|             |   | $-5V \leq V_{CM} \leq 5V$                            | 70<br><b>65</b>     | 74              |                     |                        |
| PSRR        | Power Supply Rejection Ratio              | $5V \leq V^+ \leq 30V$ , $V_{CM} = -4.5V$            | 78<br><b>74</b>     | 100             |                     | dB                     |
| CMVR        | Input Common Mode Voltage<br>Range        | CMRR > 50 dB   |                     | -5.3            | -5.1<br><b>-5</b>   | V                      |
|             |   |  | 5.1<br><b>5.0</b>   | 5.3             |                     |                        |
| $A_{VOL}$   | Large Signal Voltage Gain                 | $-4V \leq V_O \leq 4V$<br>$R_L = 10 k\Omega$ to $0V$ | 72<br><b>70</b>     | 80              |                     | dB                     |
| $V_O$       | Output Swing<br>High                      | $R_L = 10 k\Omega$ to $0V$<br>$V_{ID} = 100 mV$      |                     | 75              | 250<br><b>300</b>   | mV from<br>either rail |
|             |   | $R_L = 2 k\Omega$ to $0V$<br>$V_{ID} = 100 mV$       |                     | 125             | 350<br><b>400</b>   |                        |
|             | Output Swing<br>Low                       | $R_L = 10 k\Omega$ to $0V$<br>$V_{ID} = -100 mV$     |                     | 10              | 250<br><b>300</b>   |                        |
|             |   | $R_L = 2 k\Omega$ to $0V$<br>$V_{ID} = -100 mV$      |                     | 30              | 350<br><b>400</b>   |                        |
| $I_{SC}$    | Output Short Circuit Current              | Sourcing from $V^+$ , $V_{ID} = 200 mV$<br>(Note 9)  | 90                  | 120             |                     | mA                     |
|             |   | Sinking to $V^-$ , $V_{ID} = -200 mV$<br>(Note 9)    | 90                  | 100             |                     |                        |

| Symbol    | Parameter                           | Condition   | Min<br>(Note 7) | Typ<br>(Note 6) | Max<br>(Note 7)   | Units                        |
|-----------|-------------------------------------|---|-----------------|-----------------|-------------------|------------------------------|
| $I_{OUT}$ | Output Current                      | $V_{ID} = \pm 200 \text{ mV}$ , $V_O = 1 \text{ V}$ from rails                              |                 | $\pm 65$        |                   | mA                           |
| $I_S$     | Total Supply Current                | No Load, $V_{CM} = -4.5 \text{ V}$  |                 | 1.5             | 2.4<br><b>2.6</b> | mA                           |
| SR        | Slew Rate<br>(Note 8)               | $A_V = +1$ , $V_I = 8 \text{ V}$ Step, $R_L = 1 \text{ M}\Omega$ ,<br>$C_L = 10 \text{ pF}$ |                 | 13.2            |                   | V/ $\mu\text{s}$             |
| $R_{OUT}$ | Close Loop Output Resistance        | $A_V = +1$ , $f = 100 \text{ kHz}$  |                 | 3               |                   | $\Omega$                     |
| $f_u$     | Unity Gain Frequency                | $R_L = 10 \text{ M}\Omega$ , $C_L = 20 \text{ pF}$  |                 | 7.9             |                   | MHz                          |
| GBWP      | Gain Bandwidth Product              | $f = 50 \text{ kHz}$  |                 | 19.9            |                   | MHz                          |
| $e_n$     | Input Referred Voltage Noise        | $f = 2 \text{ kHz}$   |                 | 14.7            |                   | $\text{nV}/\sqrt{\text{Hz}}$ |
| $i_n$     | Input Referred Current Noise        | $f = 2 \text{ kHz}$   |                 | 1.3             |                   | $\text{pA}/\sqrt{\text{Hz}}$ |
| THD+N     | Total Harmonic Distortion<br>+Noise | $A_V = +2$ , $R_L = 100 \text{ k}\Omega$ , $f = 1 \text{ kHz}$<br>$V_O = 8 \text{ V}_{PP}$  |                 | -87             |                   | dB                           |
| CT Rej.   | Crosstalk Rejection                 | $f = 3 \text{ MHz}$ , Driver $R_L = 10 \text{ k}\Omega$                                     |                 | 68              |                   | dB                           |

### $\pm 15 \text{ V}$ Electrical Characteristics (Note 5)

Unless otherwise specified, all limits are guaranteed for  $T_A = 25^\circ\text{C}$ ,  $V^+ = +15 \text{ V}$ ,  $V^- = -15 \text{ V}$ ,  $V_{CM} = 0 \text{ V}$ ,  $V_O = 0 \text{ V}$ , and  $R_L > 1 \text{ M}\Omega$  to  $0 \text{ V}$ . **Boldface** limits apply at the temperature extremes.

| Symbol      | Parameter                                 | Condition   | Min<br>(Note 7)     | Typ<br>(Note 6) | Max<br>(Note 7)     | Units                        |
|-------------|---|---|---------------------|-----------------|---------------------|------------------------------|
| $V_{OS}$    | Input Offset Voltage                      | $V_{CM} = -14.5 \text{ V}$ and $V_{CM} = 14.5 \text{ V}$                                  | -5<br><b>-6</b>     | $\pm 2$         | +5<br><b>+6</b>     | mV                           |
| TC $V_{OS}$ | Input Offset Voltage<br>Temperature Drift | $V_{CM} = -14.5 \text{ V}$ and $V_{CM} = 14.5 \text{ V}$<br>(Note 10)                     |                     | $\pm 2$         |                     | $\mu\text{V}/^\circ\text{C}$ |
| $I_B$       | Input Bias Current                        | (Note 11)   | -2.0<br><b>-2.5</b> | $\pm 1.0$       | +2.0<br><b>+2.5</b> | $\mu\text{A}$                |
| $I_{OS}$    | Input Offset Current                      |   |                     | 20              | 250<br><b>300</b>   | nA                           |
| CMRR        | Common Mode Rejection Ratio               | $-15 \text{ V} \leq V_{CM} \leq 12 \text{ V}$   | 74<br><b>74</b>     | 88              |                     | dB                           |
|             |   | $-15 \text{ V} \leq V_{CM} \leq 15 \text{ V}$   | 72<br><b>72</b>     | 80              |                     |                              |
| PSRR        | Power Supply Rejection Ratio              | $-10 \text{ V} \leq V^+ \leq 15 \text{ V}$ , $V_{CM} = -14.5 \text{ V}$                   | 78<br><b>74</b>     | 100             |                     | dB                           |
| CMVR        | Input Common Mode Voltage<br>Range        | CMRR > 50 dB  |                     | -15.3           | -15.1<br><b>-15</b> | V                            |
|             |   |   | 15.1<br><b>15</b>   | 15.3            |                     |                              |
| $A_{VOL}$   | Large Signal Voltage Gain                 | $-14 \text{ V} \leq V_O \leq 14 \text{ V}$<br>$R_L = 10 \text{ k}\Omega$ to $0 \text{ V}$ | 72<br><b>70</b>     | 80              |                     | dB                           |
| $V_O$       | Output Swing<br>High                      | $R_L = 10 \text{ k}\Omega$ to $0 \text{ V}$<br>$V_{ID} = 100 \text{ mV}$                  |                     | 100             | 350<br><b>400</b>   | mV from<br>either rail       |
|             |   | $R_L = 2 \text{ k}\Omega$ to $0 \text{ V}$<br>$V_{ID} = 100 \text{ mV}$                   |                     | 200             | 550<br><b>600</b>   |                              |
|             | Output Swing<br>Low                       | $R_L = 10 \text{ k}\Omega$ to $0 \text{ V}$<br>$V_{ID} = -100 \text{ mV}$                 |                     | 20              | 450<br><b>500</b>   |                              |
|             |   | $R_L = 2 \text{ k}\Omega$ to $0 \text{ V}$<br>$V_{ID} = -100 \text{ mV}$                  |                     | 25              | 550<br><b>600</b>   |                              |

| Symbol    | Parameter                           | Condition   | Min<br>(Note 7) | Typ<br>(Note 6) | Max<br>(Note 7) | Units                  |
|-----------|-------------------------------------|---|-----------------|-----------------|-----------------|------------------------|
| $I_{SC}$  | Output Short Circuit Current        | Sourcing from $V^+$ , $V_{ID} = 200$ mV<br>(Note 9)                             |                 | 140             |                 | mA                     |
|           |                                     | Sinking to $V^-$ , $V_{ID} = -200$ mV<br>(Note 9)                               |                 | 140             |                 |                        |
| $I_{OUT}$ | Output Current                      | $V_{ID} = \pm 200$ mV, $V_O = 1$ V from rails                                   |                 | $\pm 70$        |                 | mA                     |
| $I_S$     | Total Supply Current                | No Load, $V_{CM} = -14.5$ V   |                 | 2.0             | 2.5<br>3.0      | mA                     |
| SR        | Slew Rate<br>(Note 8)               | $A_V = +1$ , $V_I = 20$ V Step, $R_L = 1$ M $\Omega$ ,<br>$C_L = 10$ pF         |                 | 15.2            |                 | V/ $\mu$ s             |
| $f_u$     | Unity Gain Frequency                | $R_L = 10$ M $\Omega$ , $C_L = 20$ pF   |                 | 9               |                 | MHz                    |
| GBWP      | Gain Bandwidth Product              | $f = 50$ kHz  |                 | 21              |                 | MHz                    |
| $e_n$     | Input Referred Voltage Noise        | $f = 2$ kHz   |                 | 15.5            |                 | nV/ $\sqrt{\text{Hz}}$ |
| $i_n$     | Input Referred Current Noise        | $f = 2$ kHz   |                 | 1               |                 | pA/ $\sqrt{\text{Hz}}$ |
| THD+N     | Total Harmonic Distortion<br>+Noise | $A_V = +2$ , $R_L = 100$ k $\Omega$ , $f = 1$ kHz<br>$V_O = 25$ V <sub>PP</sub> |                 | -93             |                 | dB                     |
| CT Rej.   | Crosstalk Rejection                 | $f = 3$ MHz, Driver $R_L = 10$ k $\Omega$                                       |                 | 68              |                 | dB                     |

**Note 1:** Absolute Maximum Ratings indicate limits beyond which damage to the device may occur. Operating Rating indicate conditions for which the device is intended to be functional, but specific performance is not guaranteed. For guaranteed specifications and the test conditions, see the Electrical Characteristics.

**Note 2:** Human Body Model, applicable std. MIL-STD-883, Method 3015.7. Machine Model, applicable std. JESD22-A115-A (ESD MM std. of JEDEC) Field-Induced Charge-Device Model, applicable std. JESD22-C101-C (ESD FICDM std. of JEDEC).

**Note 3:** Applies to both single-supply and split-supply operation. Continuous short circuit operation at elevated ambient temperature can result in exceeding the maximum allowed junction temperature of 150°C.

**Note 4:** The maximum power dissipation is a function of  $T_{J(MAX)}$ ,  $\theta_{JA}$ . The maximum allowable power dissipation at any ambient temperature is  $P_D = (T_{J(MAX)} - T_A) / \theta_{JA}$ . All numbers apply for packages soldered directly onto a PC Board.

**Note 5:** Electrical Table values apply only for factory testing conditions at the temperature indicated. Factory testing conditions result in very limited self-heating of the device such that  $T_J = T_A$ . No guarantee of parametric performance is indicated in the electrical tables under conditions of internal self-heating where  $T_J > T_A$ .

**Note 6:** Typical values represent the most likely parametric norm as determined at the time of characterization. Actual typical values may vary over time and will also depend on the application and configuration. The typical values are not tested and are not guaranteed on shipped production material.

**Note 7:** All limits are guaranteed by testing or statistical analysis.

**Note 8:** Slew rate is the slower of the rising and falling slew rates. Connected as a Voltage Follower.

**Note 9:** Short circuit test is a momentary test. Output short circuit duration is infinite for  $V_S \leq 6$  V at room temperature and below. For  $V_S > 6$  V, allowable short circuit duration is 1.5 ms.

**Note 10:** Offset voltage temperature drift determined by dividing the change in  $V_{OS}$  at temperature extremes into the total temperature change.

**Note 11:** Positive current corresponds to current flowing in the device.

## Connection Diagrams

[查询 LM7332MM 供应商](#)

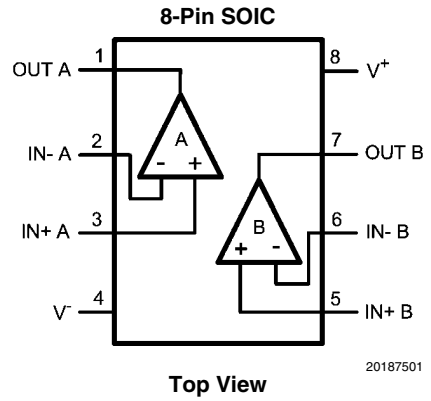
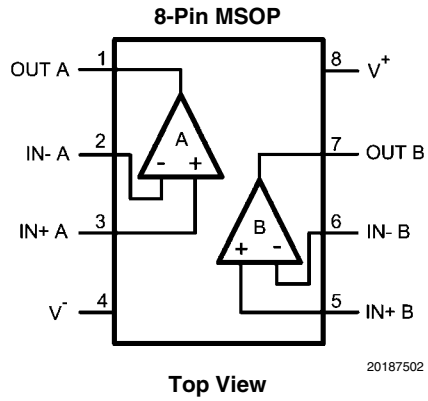

## Ordering Information

| Package    | Part Number | Package Marking | Transport Media         | NSC Drawing |
|------------|-------------|-----------------|-------------------------|-------------|
| 8-Pin MSOP | LM7332MM    | AA5A            | 1k Unit Tape and Reel   | MUA08A      |
|            | LM7332MME   |                 | 250 Units Tape and Reel |             |
|            | LM7332MMX   |                 | 3.5k Unit Tape and Reel |             |
| 8-Pin SOIC | LM7332MA    | LM7332MA        | 95 Units/Rail           | M08A        |
|            | LM7332MAX   |                 | 2.5k Unit Tape and Reel |             |

# Typical Performance Characteristics

Unless otherwise specified,  $T_A = 25^\circ\text{C}$ .

[查询"LM7332MM"供应商](#)

**$V_{OS}$  Distribution**

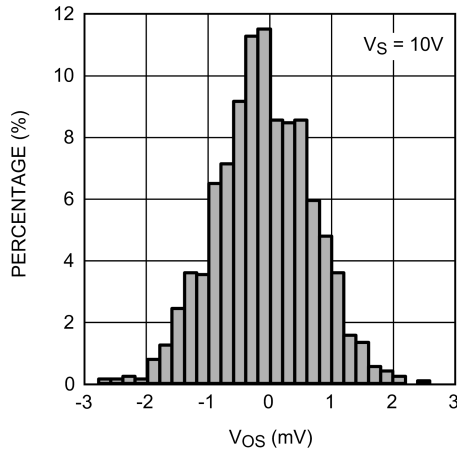

20187551

**$V_{OS}$  vs.  $V_{CM}$  (Unit 1)**

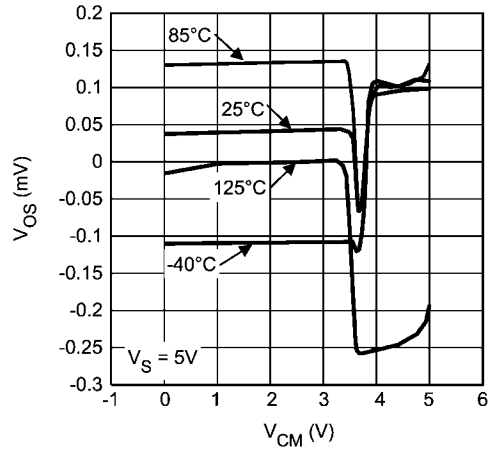

20187503

**$V_{OS}$  vs.  $V_{CM}$  (Unit 2)**

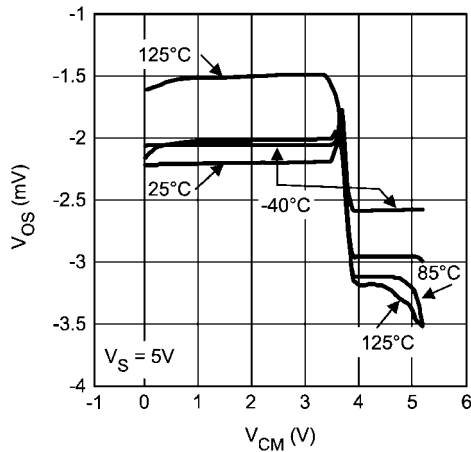

20187504

**$V_{OS}$  vs.  $V_{CM}$  (Unit 3)**

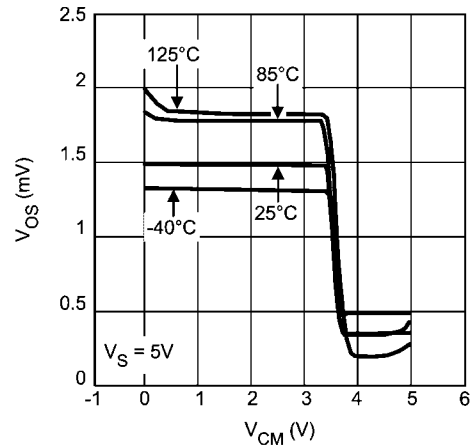

20187505

**$V_{OS}$  vs.  $V_{CM}$  (Unit 1)**

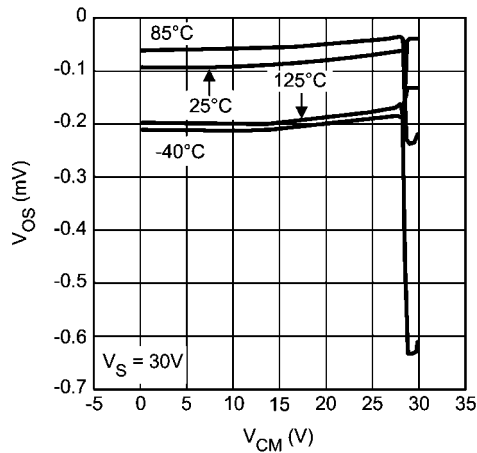

20187506

**$V_{OS}$  vs.  $V_{CM}$  (Unit 2)**

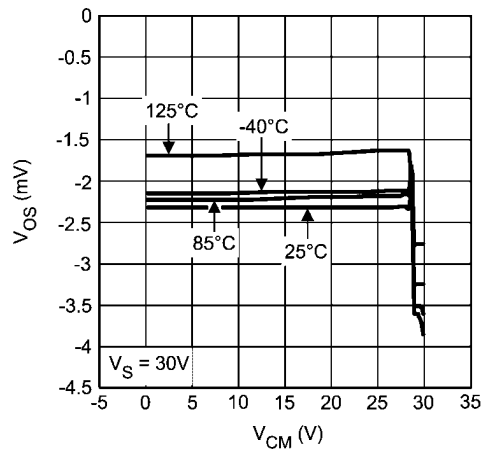

20187507

查询"LM7332MM"供应商

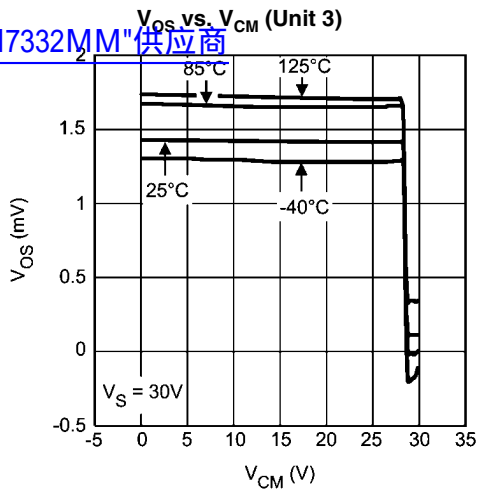

20187508

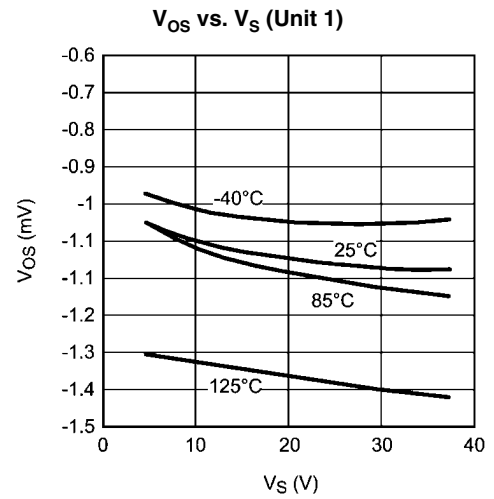

20187524

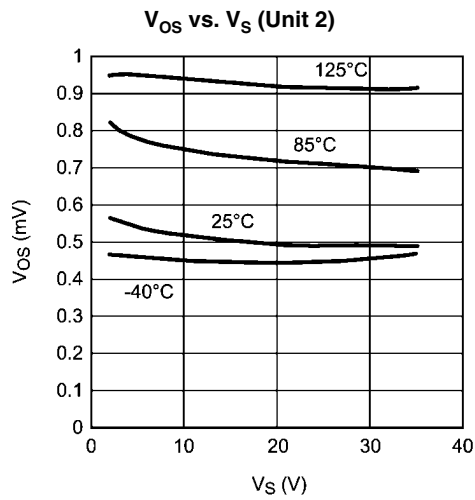

20187525

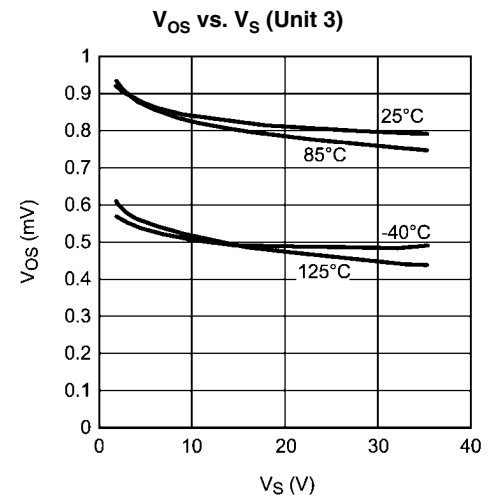

20187526

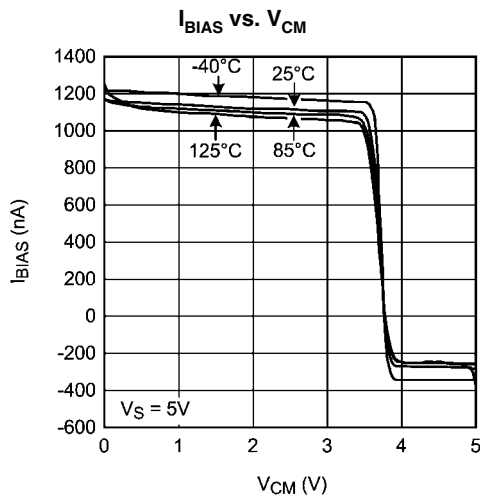

20187528

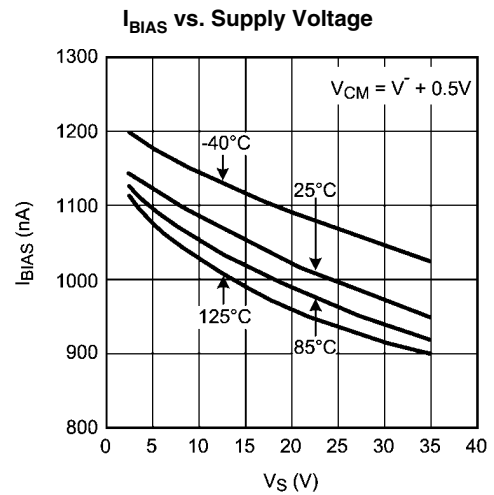

20187527



查询"LM7332MM"供应商

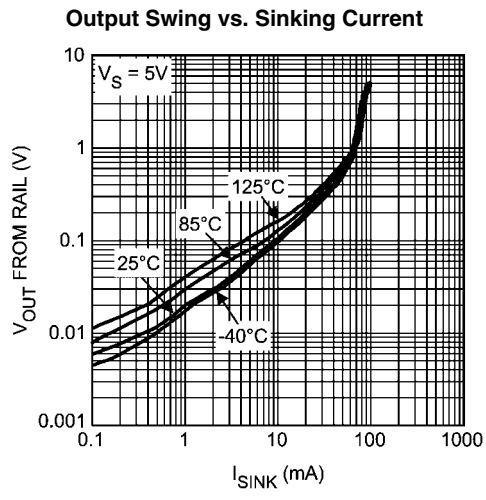
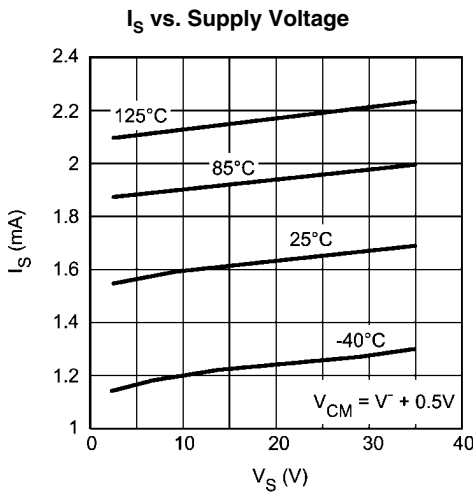
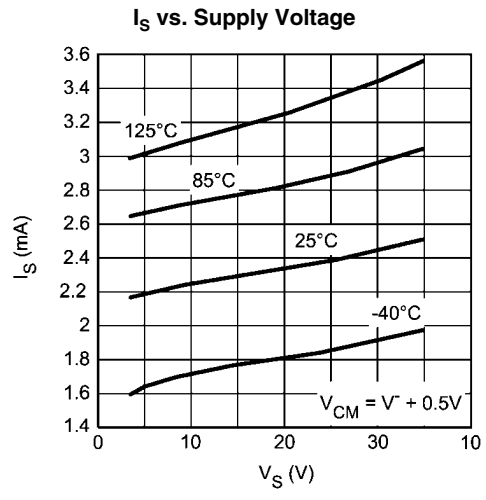
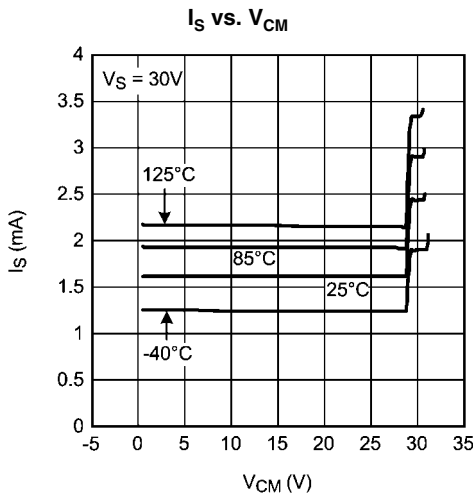
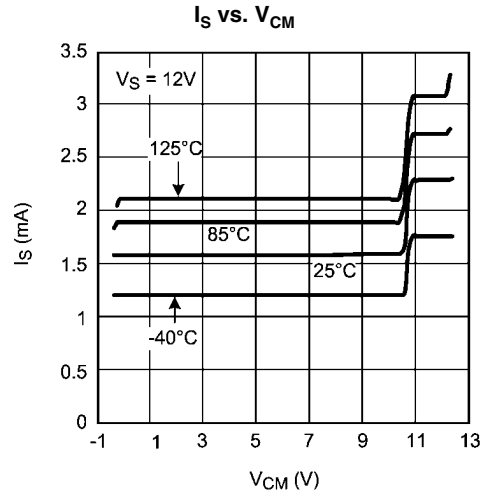
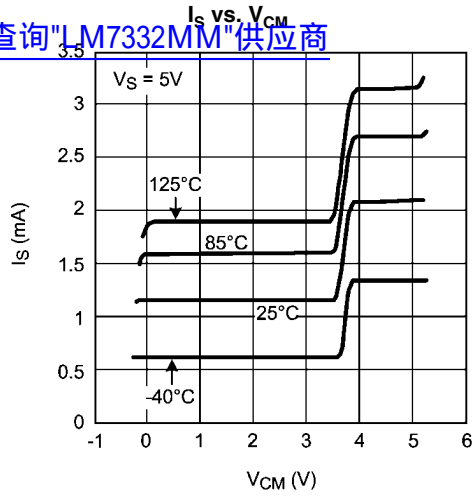

查询"LM7332MM"供应商

Output Swing vs. Sinking Current

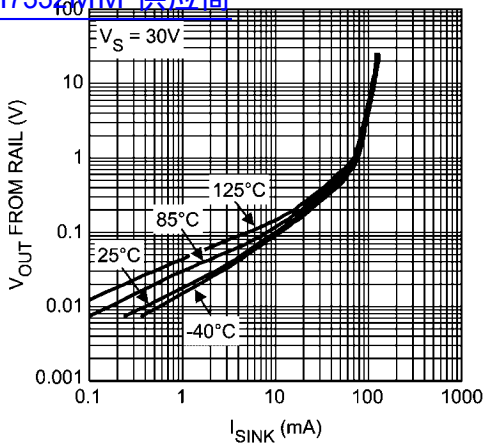

20187531

Output Swing vs. Sourcing Current

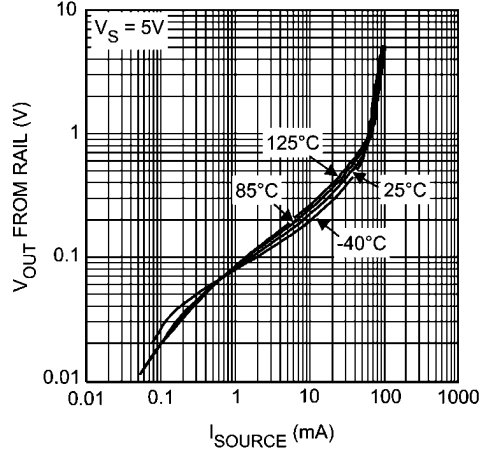

20187517

Output Swing vs. Sourcing Current

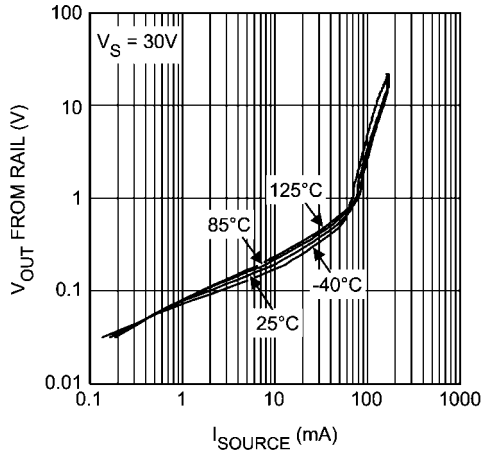

20187518

Positive Output Swing vs. Supply Voltage

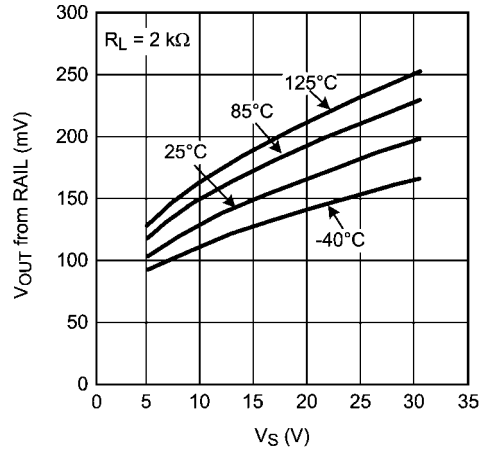

20187522

Positive Output Swing vs. Supply Voltage

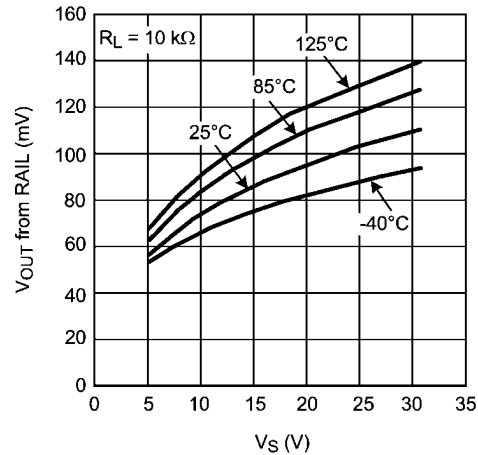

20187519

Negative Output Swing vs. Supply Voltage

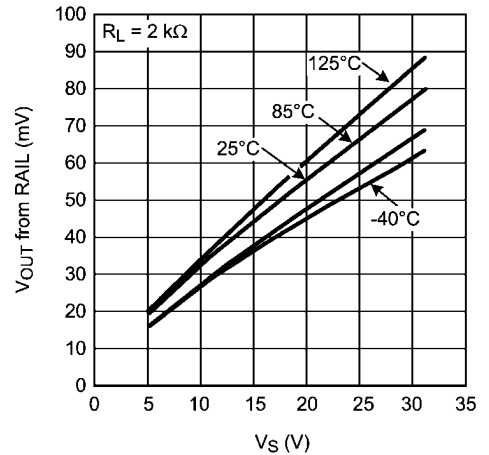

20187520

Negative Output Swing vs. Supply Voltage

查询"LM7332MM"供应商

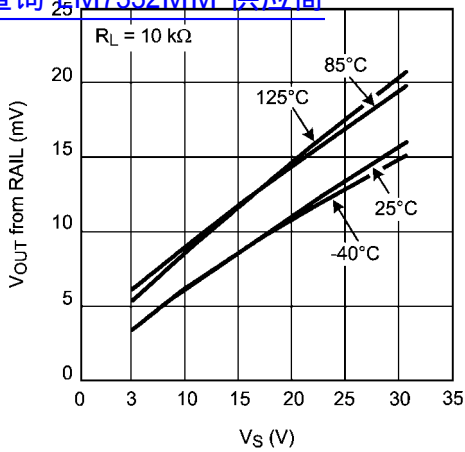

20187521

Open Loop Frequency Response with Various Capacitive Loads

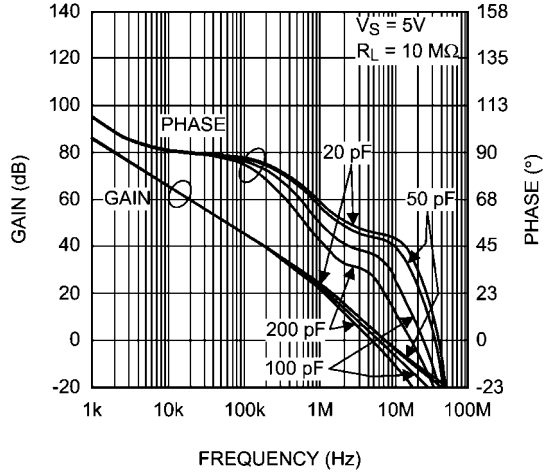

20187540

Open Loop Frequency Response with Various Capacitive Loads

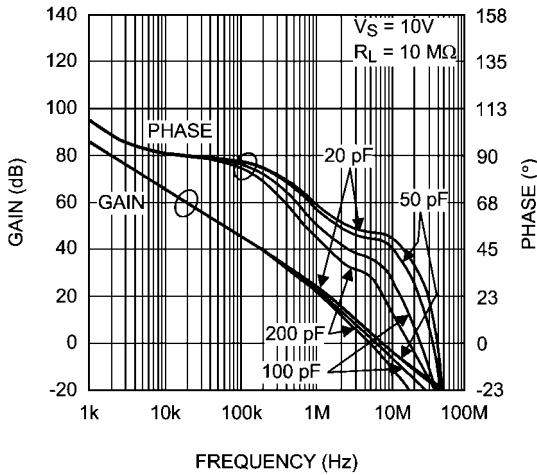

20187541

Open Loop Frequency Response with Various Capacitive Loads

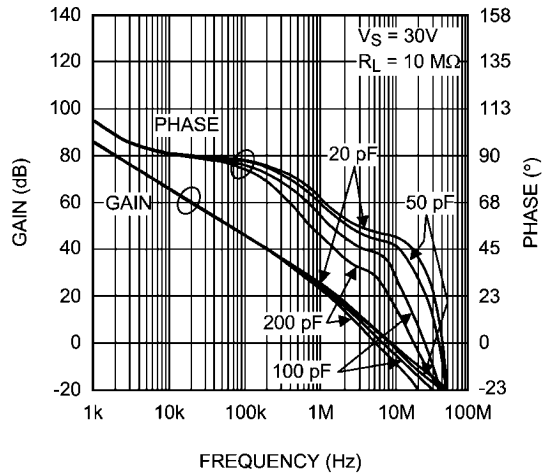

20187542

Open Loop Frequency Response vs. with Various Resistive Loads

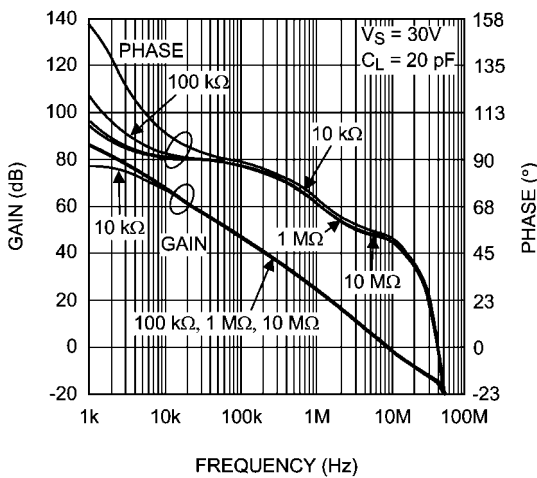

20187539

Open Loop Frequency Response vs. with Various Supply Voltages

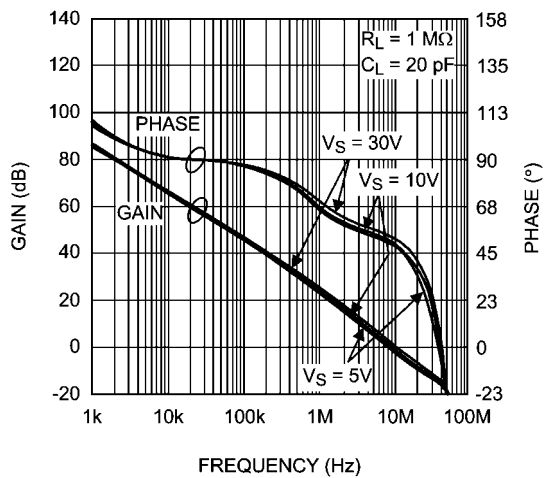

20187537

Open Loop Frequency Response at Various Temperatures

查询"LM7332MM"供应商

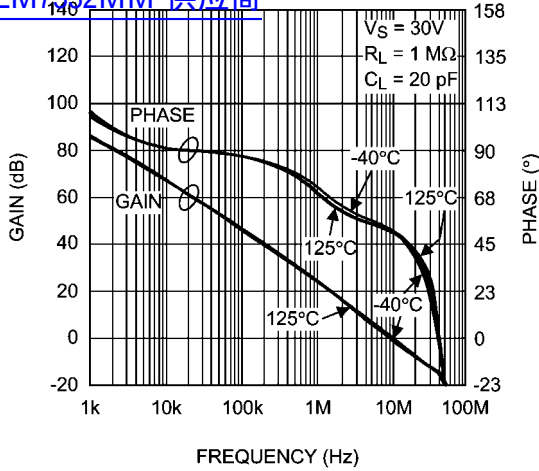

20187538

Phase Margin vs. Capacitive Load

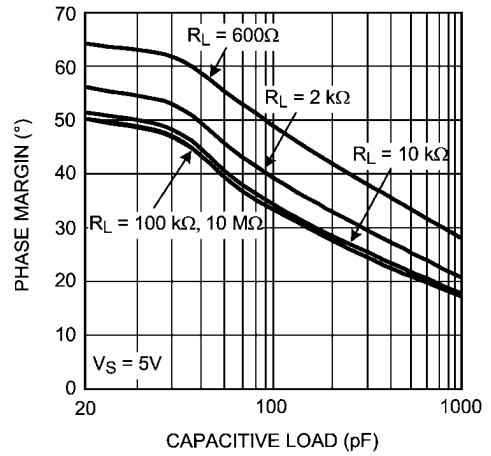

20187543

Phase Margin vs. Capacitive Load

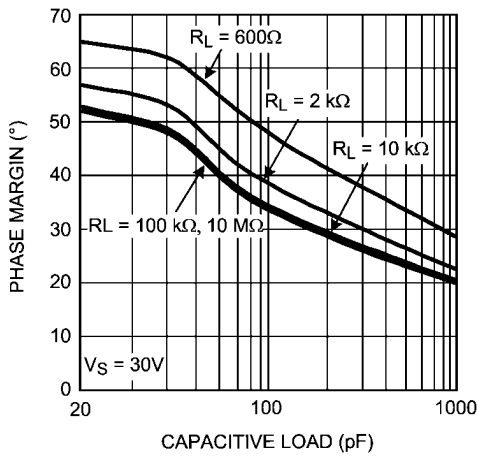

20187544

CMRR vs. Frequency

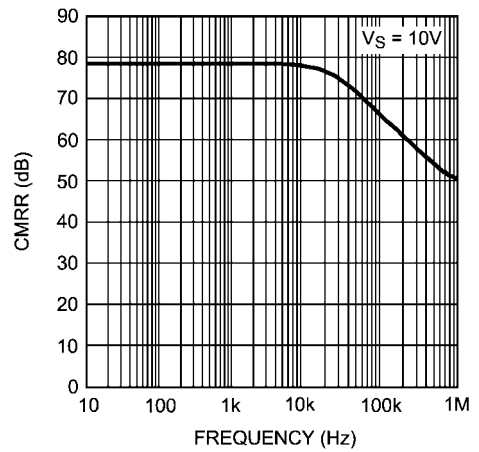

20187545

+PSRR vs. Frequency

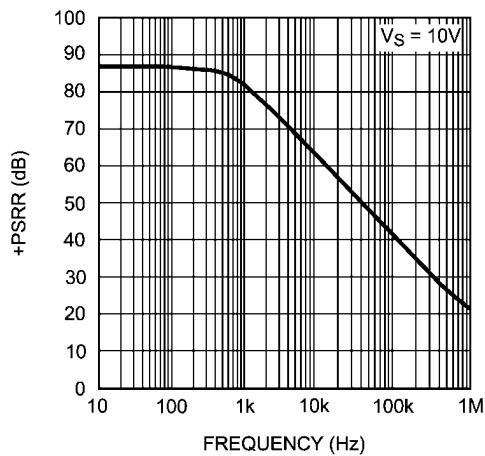

20187546

-PSRR vs. Frequency

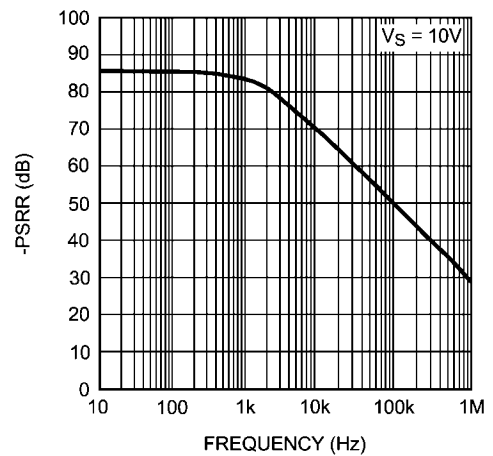

20187547

Step Response for Various Amplitudes  
 查询"LM7332MM"供应商

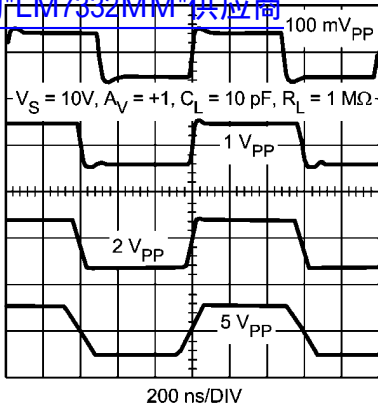

20187533

Step Response for Various Amplitudes

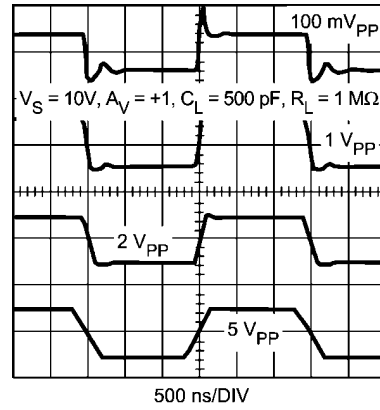

20187532

Large Signal Step Response for Various Capacitive Loads

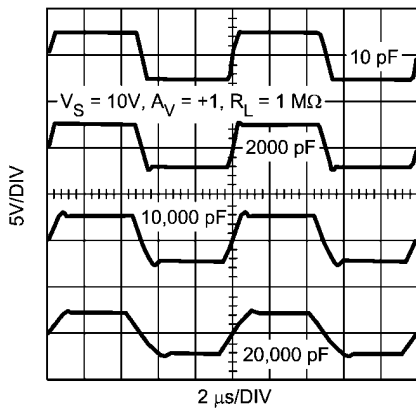

20187534

Input Referred Noise Density vs. Frequency

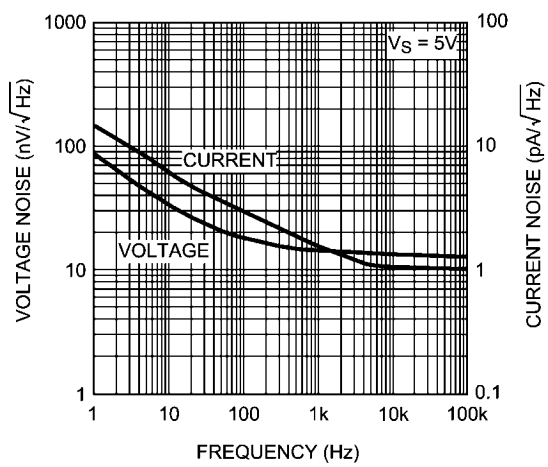

20187548

Input Referred Noise Density vs. Frequency

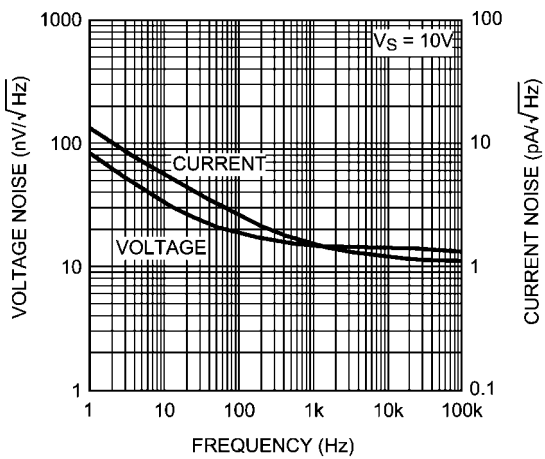

20187549

Input Referred Noise Density vs. Frequency

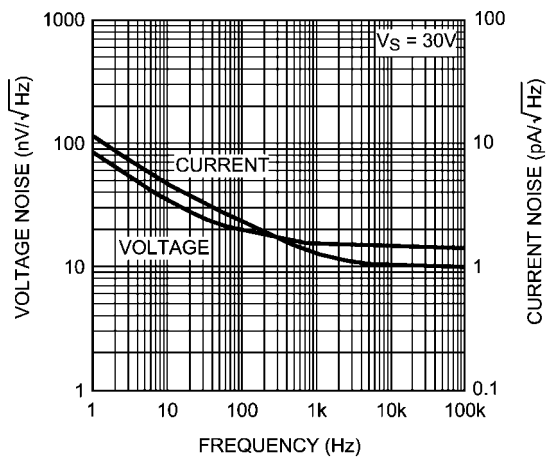

20187550

查询"LM7332MM"供应商

THD+N vs. Output Amplitude (V<sub>pp</sub>)

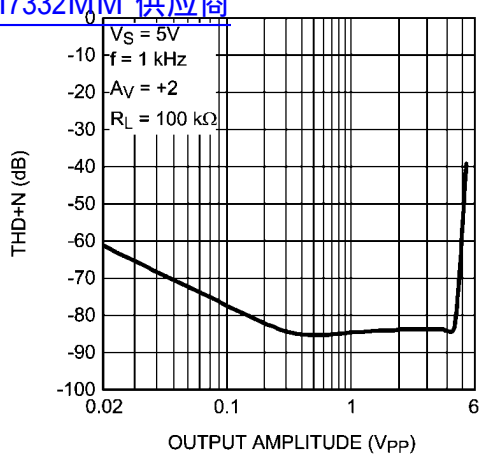

20187552

THD+N vs. Output Amplitude (V<sub>pp</sub>)

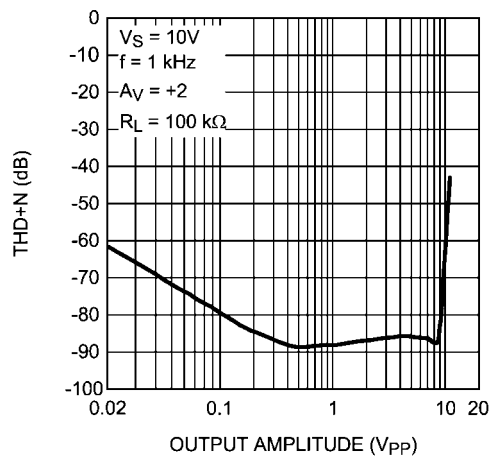

20187553

THD+N vs. Output Amplitude (V<sub>pp</sub>)

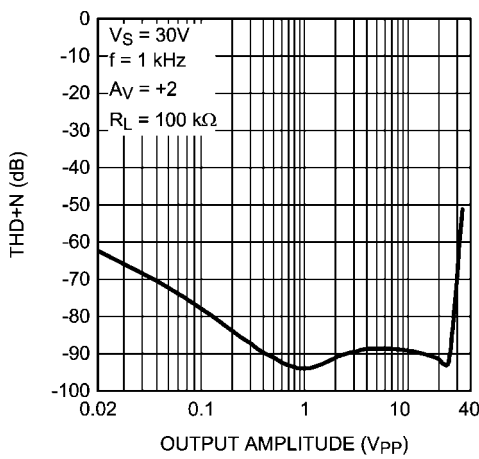

20187554

Crosstalk vs. Frequency

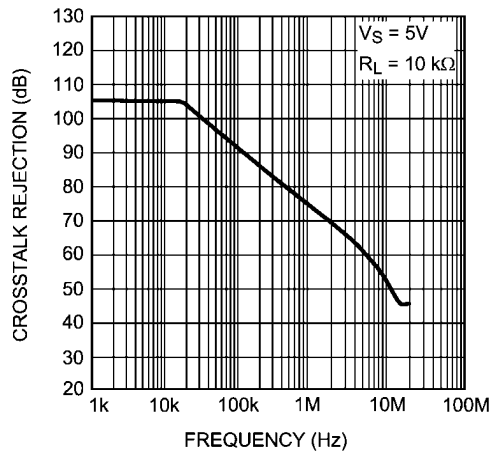

20187536

## Application Information

查询"LM7332MM"供应商

### ADVANTAGES OF THE LM7332

#### Wide Operating Voltage Range

The LM7332 has an operating voltage from 2.5V to 32V which makes it suitable for industrial and automotive applications.

#### RRIO with 100 mA Output Current

The LM7332 takes advantages of National Semiconductor's VIP3 process which enables high current driving from the rails. Rail-to-rail output swing provides the maximum possible output dynamic range. The LM7332 eliminates the need to use extra transistors when driving large capacitive loads, therefore reducing the application cost and space.

#### -40°C to 125°C Operating Temperature Range

The LM7332 has an operating temperature ranging from -40°C to 125°C, which is Automotive Grade 1, and also meets most industrial requirements.

#### SOIC and MSOP Packages

The LM7332 are offered in both the standard SOIC package and the space saving MSOP package. Please refer to the Physical Dimensions on page 17 for details.

#### OUTPUT VOLTAGE SWING CLOSE TO V-

The LM7332's output stage design allows voltage swings to within millivolts of either supply rail for maximum flexibility and improved useful range. Because of this design architecture, with output approaching either supply rail, the output transistor Collector-Base junction reverse bias will decrease. With output less than a  $V_{be}$  from either rail, the corresponding output transistor operates near saturation. In this mode of operation, the transistor will exhibit higher junction capacitance and lower  $f_t$  which will reduce phase margin. With the Noise Gain ( $NG = 1 + R_F/R_G$ ,  $R_F$  and  $R_G$  are external gain setting resistors) of 2 or higher, there is sufficient phase margin that this reduction in phase margin is of no consequence. However, with lower Noise Gain ( $<2$ ) and with less than 150 mV to the supply rail, if the output loading is light, the phase margin reduction could result in unwanted oscillations.

In the case of the LM7332, due to inherent architectural specifics, the oscillation occurs only with respect to the output transistor at V- when output swings to within 150 mV of V-. However, if this output transistor's collector current is larger than its idle value of a few microamps, the phase margin loss becomes insignificant. In this case, 300  $\mu$ A is the required output transistor's collector current to remedy this situation. Therefore, when all the aforementioned critical conditions are present at the same time ( $NG < 2$ ,  $V_{OUT} < 150$  mV from supply rails, & output load is light) it is possible to ensure stability by adding a load resistor to the output to provide the output transistor the necessary minimum collector current (300  $\mu$ A).

For 12V (or  $\pm 6$ V) operation, for example, add a 39 k $\Omega$  resistor from the output to V+ to cause 300  $\mu$ A output sinking current and ensure stability. This is equivalent to about 15% increase in total quiescent power dissipation.

#### DRIVING CAPACITIVE LOADS

The LM7332 is specifically designed to drive unlimited capacitive loads without oscillations. In addition, the output current handling capability of the device allows for good slewing characteristics even with large capacitive loads as shown in *Figure 1*. The combination of these features is ideal for applications such as TFT flat panel buffers, A/D converter input amplifiers and power transistor driver.

However, as in most op amps, addition of a series isolation resistor between the op amp and the capacitive load improves the settling and overshoot performance.

Output current drive is an important parameter when driving capacitive loads. This parameter will determine how fast the output voltage can change. Referring to *Figure 1*, two distinct regions can be identified. Below about 10,000 pF, the output Slew Rate is solely determined by the op amp's compensation capacitor value and available current into that capacitor. Beyond 10 nF, the Slew Rate is determined by the op amp's available output current. An estimate of positive and negative slew rates for loads larger than 100 nF can be made by dividing the short circuit current value by the capacitor.

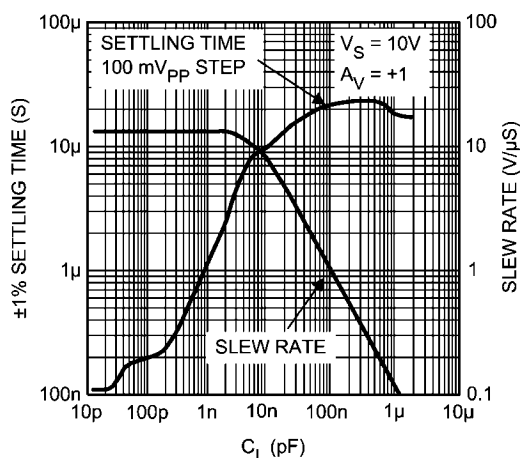

20187579

FIGURE 1. Settling Time and Slew Rate vs. Capacitive Load

#### ESTIMATING THE OUTPUT VOLTAGE SWING

It is important to keep in mind that the steady state output current will be less than the current available when there is an input overdrive present. For steady state conditions, *Figure 2* and *Figure 3* plots can be used to predict the output swing. These plots also show several load lines corresponding to loads tied between the output and ground. In each case, the intersection of the device plot at the appropriate temperature with the load line would be the typical output swing possible for that load. For example, a 600 $\Omega$  load can accommodate an output swing to within 100 mV of V- and to 250 mV of V+ ( $V_S = \pm 5V$ ) corresponding to a typical 9.65  $V_{PP}$  unclipped swing.

查询"LM7332MM"供应商

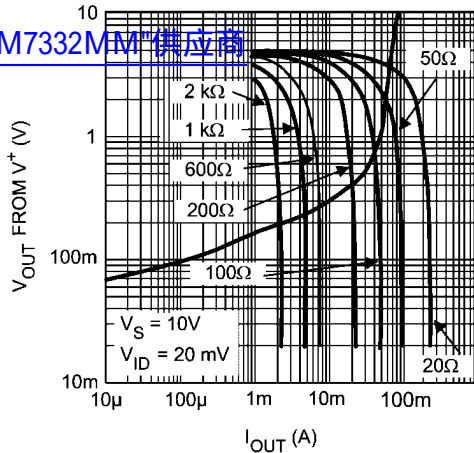

20187590

**FIGURE 2. Steady State Output Sourcing Characteristics with Load Lines**

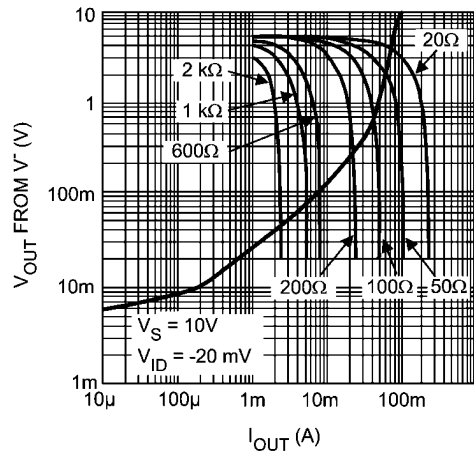

20187591

**FIGURE 3. Steady State Output Sinking Characteristics with Load Lines**

#### OUTPUT SHORT CIRCUIT CURRENT AND DISSIPATION ISSUES

The LM7332 output stage is designed for maximum output current capability. Even though momentary output shorts to ground and either supply can be tolerated at all operating voltages, longer lasting short conditions can cause the junction temperature to rise beyond the absolute maximum rating of the device, especially at higher supply voltage conditions. Below supply voltage of 6V, the output short circuit condition can be tolerated indefinitely.

With the op amp tied to a load, the device power dissipation consists of the quiescent power due to the supply current flow into the device, in addition to power dissipation due to the load current. The load portion of the power itself could include an average value (due to a DC load current) and an AC component. DC load current would flow if there is an output voltage

offset, or the output AC average current is non-zero, or if the op amp operates in a single supply application where the output is maintained somewhere in the range of linear operation. Therefore:

$$P_{\text{TOTAL}} = P_Q + P_{\text{DC}} + P_{\text{AC}}$$

$$P_Q = I_S \cdot V_S$$

Op Amp Quiescent Power  
Dissipation

$$P_{\text{DC}} = I_O \cdot (V_r - V_o)$$

DC Load Power

$$P_{\text{AC}} = \text{See Table 1 below}$$

AC Load Power

where:

$I_S$ : Supply Current

$V_S$ : Total Supply Voltage ( $V^+ - V^-$ )

$V_O$ : Average Output Voltage

$V_r$ :  $V^+$  for sourcing and  $V^-$  for sinking current

Table 1 below shows the maximum AC component of the load power dissipated by the op amp for standard Sinusoidal, Triangular, and Square Waveforms:

**TABLE 1. Normalized AC Power Dissipated in the Output Stage for Standard Waveforms**

| $P_{\text{AC}} (\text{W} \cdot \Omega / \text{V}^2)$ |                       |                       |
|--|-----------------------|-----------------------|
| Sinusoidal   | Triangular            | Square                |
| $50.7 \times 10^{-3}$                                | $46.9 \times 10^{-3}$ | $62.5 \times 10^{-3}$ |

The table entries are normalized to  $V_S^2/R_L$ . To figure out the AC load current component of power dissipation, simply multiply the table entry corresponding to the output waveform by the factor  $V_S^2/R_L$ . For example, with  $\pm 12\text{V}$  supplies, a  $600\Omega$  load, and triangular waveform power dissipation in the output stage is calculated as:

$$P_{\text{AC}} = (46.9 \times 10^{-3}) \cdot [24^2/600] = 45.0 \text{ mW}$$

The maximum power dissipation allowed at a certain temperature is a function of maximum die junction temperature ( $T_{J(\text{MAX})}$ ) allowed, ambient temperature  $T_A$ , and package thermal resistance from junction to ambient,  $\theta_{JA}$ .

$$P_{D(\text{MAX})} = \frac{T_{J(\text{MAX})} - T_A}{\theta_{JA}}$$

For the LM7332, the maximum junction temperature allowed is  $150^\circ\text{C}$  at which no power dissipation is allowed. The power capability at  $25^\circ\text{C}$  is given by the following calculations:

For MSOP package:

$$P_{D(\text{MAX})} = \frac{150^\circ\text{C} - 25^\circ\text{C}}{235^\circ\text{C/W}} = 0.53\text{W}$$

For SOIC package:

$$P_{D(\text{MAX})} = \frac{150^\circ\text{C} - 25^\circ\text{C}}{165^\circ\text{C/W}} = 0.76\text{W}$$



Similarly, the power capability at 125°C is given by:

For MSOP package [查询"LM7332MM"供应商](#)

$$P_{D(MAX)} = \frac{150^{\circ}\text{C} - 125^{\circ}\text{C}}{235^{\circ}\text{C/W}} = 0.11\text{W}$$

For SOIC package:

$$P_{D(MAX)} = \frac{150^{\circ}\text{C} - 125^{\circ}\text{C}}{165^{\circ}\text{C/W}} = 0.15\text{W}$$

Figure 4 shows the power capability vs. temperature for MSOP and SOIC packages. The area under the maximum thermal capability line is the operating area for the device. When the device works in the operating area where  $P_{TOTAL}$  is less than  $P_{D(MAX)}$ , the device junction temperature will remain below 150°C. If the intersection of ambient temperature and package power is above the maximum thermal capability line, the junction temperature will exceed 150°C and this should be strictly prohibited.

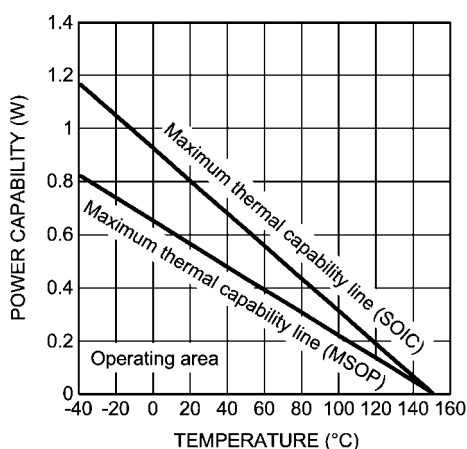

20187555

FIGURE 4. Power Capability vs. Temperature

When high power is required and ambient temperature can't be reduced, providing air flow is an effective approach to reduce thermal resistance therefore to improve power capability.

#### APPLICATION HINTS ON SUPPLY DECOUPLING

The use of supply decoupling is mandatory in most applications. As with most relatively high speed/high output current op amps, best results are achieved when each supply line is decoupled with two capacitors; a small value ceramic capacitor (~0.01  $\mu\text{F}$ ) placed very close to the supply lead in addition to a large value Tantalum or Aluminum capacitor (> 4.7  $\mu\text{F}$ ). The large capacitor can be shared by more than one device if necessary. The small ceramic capacitor maintains low supply impedance at high frequencies while the large capacitor will act as the charge "bucket" for fast load current spikes at the op amp output. The combination of these capacitors will provide supply decoupling and will help keep the op amp oscillation free under any load.

#### SIMILAR HIGH CURRENT OUTPUT DEVICES

The LM6172 has a higher GBW of 100 MHz and over 80 mA of current output. There is also a single version, the LM6171. The LM7372 has 120 MHz of GBW and 150 mA of current output. The LM7372 is available in a small pin LLP package, an 8-pin PSOP, and 16-pin SOIC packages with higher power dissipation.

The LME49600 buffer has 250 mA of current out and a 110 MHz bandwidth. The LME49600 is available in a TO-263 package for higher power dissipation.

The LM7322 is a rail-to-rail input and output part with a slightly higher GBW of 20 MHz. It has current capability of 40 mA sourcing and 65 mA sinking, and can drive unlimited capacitive loads. The LM7322 is available in both MSOP and SOIC packages.

Detailed information on these parts can be found at [www.national.com](http://www.national.com).

**Physical Dimensions** inches (millimeters) unless otherwise noted  
 查询"LM7332MM"供应商

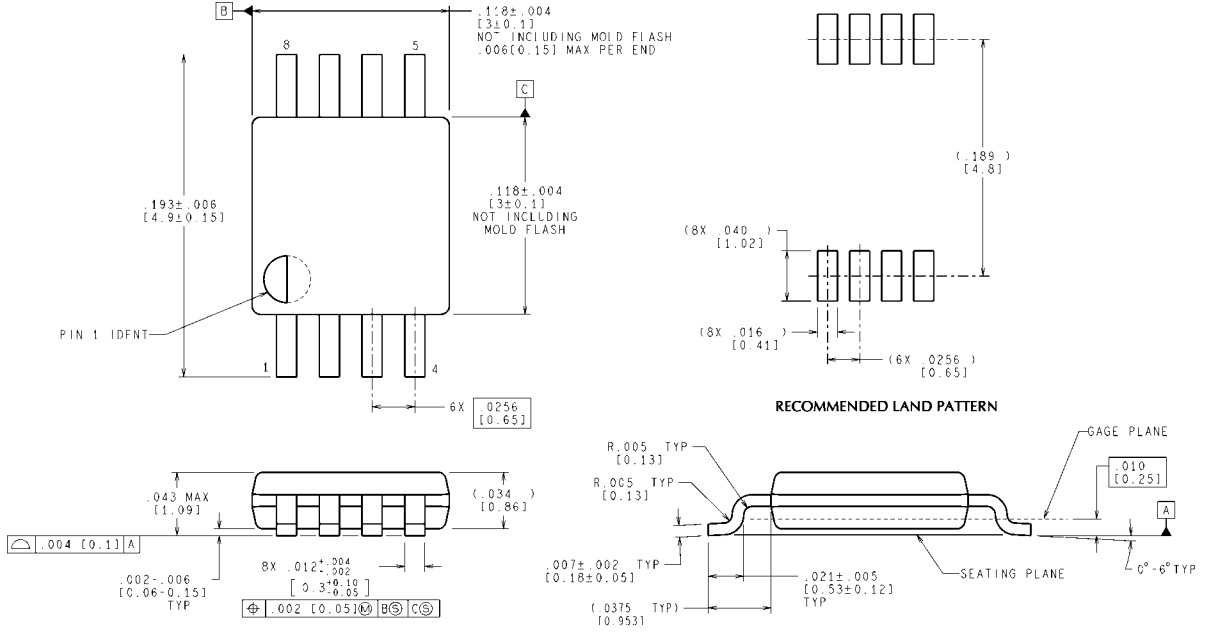

CONTROLLING DIMENSION IS INCH  
 VALUES IN [ ] ARE MILLIMETERS

MUA08A (Rev F)

**8-Pin MSOP**  
**NS Package Number MUA08A**

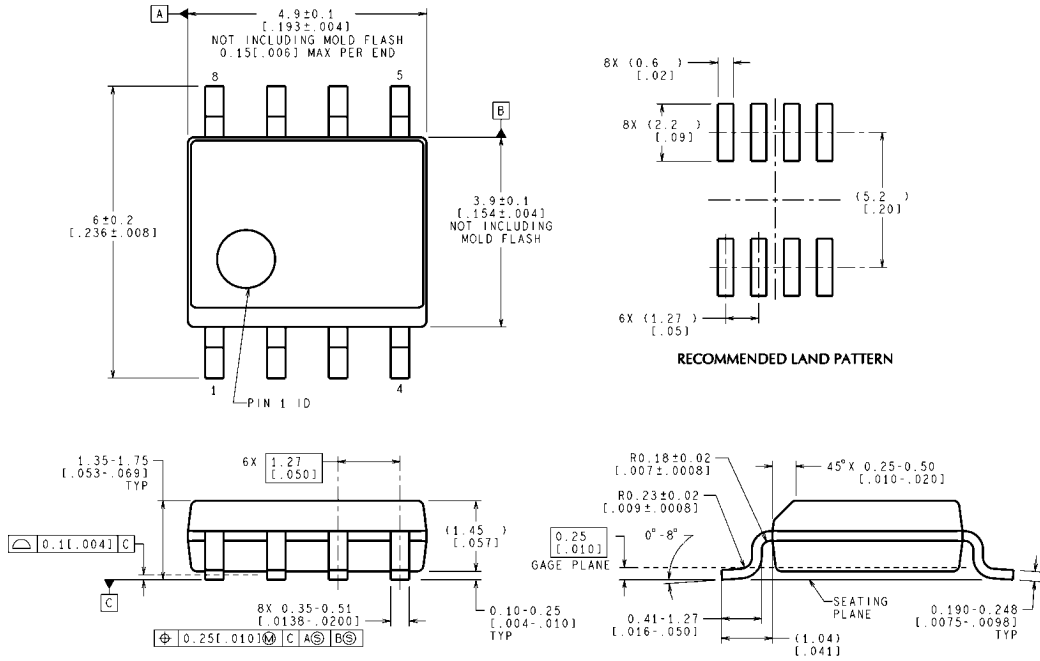

CONTROLLING DIMENSION IS MILLIMETER  
 VALUES IN [ ] ARE INCHES  
 DIMENSIONS IN ( ) FOR REFERENCE ONLY

M08A (Rev L)

**8-Pin SOIC**  
**NS Package Number M08A**

[查询"LM7332MM"供应商](#)

[查询"LM7332MM"供应商](#)

## Notes

For more National Semiconductor product information and proven design tools, visit the following Web sites at:

| Products                       |  | Design Support          |  |
|--------------------------------|--|-------------------------|--|
| Amplifiers                     | <a href="http://www.national.com/amplifiers">www.national.com/amplifiers</a>   | WEBENCH                 | <a href="http://www.national.com/webench">www.national.com/webench</a>             |
| Audio                          | <a href="http://www.national.com/audio">www.national.com/audio</a>             | Analog University       | <a href="http://www.national.com/AU">www.national.com/AU</a>                       |
| Clock Conditioners             | <a href="http://www.national.com/timing">www.national.com/timing</a>           | App Notes               | <a href="http://www.national.com/appnotes">www.national.com/appnotes</a>           |
| Data Converters                | <a href="http://www.national.com/adc">www.national.com/adc</a>                 | Distributors            | <a href="http://www.national.com/contacts">www.national.com/contacts</a>           |
| Displays                       | <a href="http://www.national.com/displays">www.national.com/displays</a>       | Green Compliance        | <a href="http://www.national.com/quality/green">www.national.com/quality/green</a> |
| Ethernet                       | <a href="http://www.national.com/ethernet">www.national.com/ethernet</a>       | Packaging               | <a href="http://www.national.com/packaging">www.national.com/packaging</a>         |
| Interface                      | <a href="http://www.national.com/interface">www.national.com/interface</a>     | Quality and Reliability | <a href="http://www.national.com/quality">www.national.com/quality</a>             |
| LVDS                           | <a href="http://www.national.com/lvds">www.national.com/lvds</a>               | Reference Designs       | <a href="http://www.national.com/refdesigns">www.national.com/refdesigns</a>       |
| Power Management               | <a href="http://www.national.com/power">www.national.com/power</a>             | Feedback                | <a href="http://www.national.com/feedback">www.national.com/feedback</a>           |
| Switching Regulators           | <a href="http://www.national.com/switchers">www.national.com/switchers</a>     |                         |  |
| LDOs                           | <a href="http://www.national.com/ldo">www.national.com/ldo</a>                 |                         |  |
| LED Lighting                   | <a href="http://www.national.com/led">www.national.com/led</a>                 |                         |  |
| PowerWise                      | <a href="http://www.national.com/powerwise">www.national.com/powerwise</a>     |                         |  |
| Serial Digital Interface (SDI) | <a href="http://www.national.com/sdi">www.national.com/sdi</a>                 |                         |  |
| Temperature Sensors            | <a href="http://www.national.com/tempsensors">www.national.com/tempsensors</a> |                         |  |
| Wireless (PLL/VCO)             | <a href="http://www.national.com/wireless">www.national.com/wireless</a>       |                         |  |

THE CONTENTS OF THIS DOCUMENT ARE PROVIDED IN CONNECTION WITH NATIONAL SEMICONDUCTOR CORPORATION ("NATIONAL") PRODUCTS. NATIONAL MAKES NO REPRESENTATIONS OR WARRANTIES WITH RESPECT TO THE ACCURACY OR COMPLETENESS OF THE CONTENTS OF THIS PUBLICATION AND RESERVES THE RIGHT TO MAKE CHANGES TO SPECIFICATIONS AND PRODUCT DESCRIPTIONS AT ANY TIME WITHOUT NOTICE. NO LICENSE, WHETHER EXPRESS, IMPLIED, ARISING BY ESTOPPEL OR OTHERWISE, TO ANY INTELLECTUAL PROPERTY RIGHTS IS GRANTED BY THIS DOCUMENT.

TESTING AND OTHER QUALITY CONTROLS ARE USED TO THE EXTENT NATIONAL DEEMS NECESSARY TO SUPPORT NATIONAL'S PRODUCT WARRANTY. EXCEPT WHERE MANDATED BY GOVERNMENT REQUIREMENTS, TESTING OF ALL PARAMETERS OF EACH PRODUCT IS NOT NECESSARILY PERFORMED. NATIONAL ASSUMES NO LIABILITY FOR APPLICATIONS ASSISTANCE OR BUYER PRODUCT DESIGN. BUYERS ARE RESPONSIBLE FOR THEIR PRODUCTS AND APPLICATIONS USING NATIONAL COMPONENTS. PRIOR TO USING OR DISTRIBUTING ANY PRODUCTS THAT INCLUDE NATIONAL COMPONENTS, BUYERS SHOULD PROVIDE ADEQUATE DESIGN, TESTING AND OPERATING SAFEGUARDS.

EXCEPT AS PROVIDED IN NATIONAL'S TERMS AND CONDITIONS OF SALE FOR SUCH PRODUCTS, NATIONAL ASSUMES NO LIABILITY WHATSOEVER, AND NATIONAL DISCLAIMS ANY EXPRESS OR IMPLIED WARRANTY RELATING TO THE SALE AND/OR USE OF NATIONAL PRODUCTS INCLUDING LIABILITY OR WARRANTIES RELATING TO FITNESS FOR A PARTICULAR PURPOSE, MERCHANTABILITY, OR INFRINGEMENT OF ANY PATENT, COPYRIGHT OR OTHER INTELLECTUAL PROPERTY RIGHT.

### LIFE SUPPORT POLICY

**NATIONAL'S PRODUCTS ARE NOT AUTHORIZED FOR USE AS CRITICAL COMPONENTS IN LIFE SUPPORT DEVICES OR SYSTEMS WITHOUT THE EXPRESS PRIOR WRITTEN APPROVAL OF THE CHIEF EXECUTIVE OFFICER AND GENERAL COUNSEL OF NATIONAL SEMICONDUCTOR CORPORATION.** As used herein:

Life support devices or systems are devices which (a) are intended for surgical implant into the body, or (b) support or sustain life and whose failure to perform when properly used in accordance with instructions for use provided in the labeling can be reasonably expected to result in a significant injury to the user. A critical component is any component in a life support device or system whose failure to perform can be reasonably expected to cause the failure of the life support device or system or to affect its safety or effectiveness.

National Semiconductor and the National Semiconductor logo are registered trademarks of National Semiconductor Corporation. All other brand or product names may be trademarks or registered trademarks of their respective holders.

Copyright© 2008 National Semiconductor Corporation

For the most current product information visit us at [www.national.com](http://www.national.com)



**National Semiconductor  
Americas Technical  
Support Center**  
Email:  
[new.feedback@nsc.com](mailto:new.feedback@nsc.com)  
Tel: 1-800-272-9959

**National Semiconductor Europe  
Technical Support Center**  
Email: [europe.support@nsc.com](mailto:europe.support@nsc.com)  
German Tel: +49 (0) 180 5010 771  
English Tel: +44 (0) 870 850 4288

**National Semiconductor Asia  
Pacific Technical Support Center**  
Email: [ap.support@nsc.com](mailto:ap.support@nsc.com)

**National Semiconductor Japan  
Technical Support Center**  
Email: [jpn.feedback@nsc.com](mailto:jpn.feedback@nsc.com)