



1.5KE6V8A/440A
1.5KE6V8CA/440CA

TRANSIL™

FEATURES

- PEAK PULSE POWER : 1500 W (10/1000µs)
- BREAKDOWN VOLTAGE RANGE :
From 6.8V to 440 V
- UNI AND BIDIRECTIONAL TYPES
- LOW CLAMPING FACTOR
- FAST RESPONSE TIME
- UL RECOGNIZED

DESCRIPTION

Transil diodes provide high overvoltage protection by clamping action. Their instantaneous response to transient overvoltages makes them particularly suited to protect voltage sensitive devices such as MOS Technology and low voltage supplied IC's.



ABSOLUTE MAXIMUM RATINGS (T_{amb} = 25°C)

Symbol	Parameter		Value	Unit
P _{PP}	Peak pulse power dissipation (see note 1)	T _j initial = T _{amb}	1500	W
P	Power dissipation on infinite heatsink	T _{amb} = 75°C	5	W
I _{FSM}	Non repetitive surge peak forward current for unidirectional types	tp = 10ms T _j initial = T _{amb}	200	A
T _{stg} T _j	Storage temperature range Maximum junction temperature		- 65 to + 175 175	°C °C
T _L	Maximum lead temperature for soldering during 10s at 5mm from case		230	°C

Note 1 : For a surge greater than the maximum values, the diode will fail in short-circuit.

THERMAL RESISTANCES

Symbol	Parameter		Value	Unit
R _{th (j-l)}	Junction to leads		20	°C/W
R _{th (j-a)}	Junction to ambient on printed circuit.	L _{lead} = 10 mm	75	°C/W



1.5KExx

ELECTRICAL CHARACTERISTICS (T_{amb} = 25°C)

Symbol	Parameter
V _{RM}	Stand-off voltage
V _{BR}	Breakdown voltage
V _{CL}	Clamping voltage
I _{RM}	Leakage current @ V _{RM}
I _{PP}	Peak pulse current
α _T	Voltage temperature coefficient
V _F	Forward voltage drop

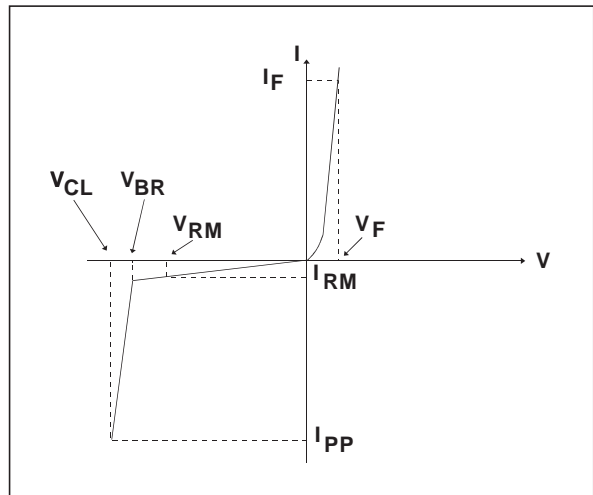

Types		I _{RM} @ V _{RM} max		V _{BR} @ I _R min nom max note2				V _{CL} @ I _{PP} max 10/1000μs		V _{CL} @ I _{PP} max 8/20μs		α _T max note3	C typ note4
Unidirectional	Bidirectional	μA	V	V	V	V	mA	V	A	V	A	10 ⁻⁴ /°C	pF
1.5KE6V8A	1.5KE6V8CA	1000	5.8	6.45	6.8	7.14	10	10.5	143	13.4	746	5.7	9500
1.5KE7V5A	1.5KE7V5CA	500	6.4	7.13	7.5	7.88	10	11.3	132	14.5	690	6.1	8500
1.5KE10A	1.5KE10CA	10	8.55	9.5	10	10.5	1	14.5	100	18.6	538	7.3	7000
1.5KE12A	1.5KE12CA	5	10.2	11.4	12	12.6	1	16.7	90	21.7	461	7.8	6000
1.5KE15A	1.5KE15CA	1	12.8	14.3	15	15.8	1	21.2	71	27.2	368	8.4	5000
1.5KE18A	1.5KE18CA	1	15.3	17.1	18	18.9	1	25.2	59.5	32.5	308	8.8	4300
1.5KE22A	1.5KE22CA	1	18.8	20.9	22	23.1	1	30.6	49	39.3	254	9.2	3700
1.5KE24A	1.5KE24CA	1	20.5	22.8	24	25.2	1	33.2	45	42.8	234	9.4	3500
1.5KE27A	1.5KE27CA	1	23.1	25.7	27	28.4	1	37.5	40	48.3	207	9.6	3200
1.5KE30A	1.5KE30CA	1	25.6	28.5	30	31.5	1	41.5	36	53.5	187	9.7	2900
1.5KE33A	1.5KE33CA	1	28.2	31.4	33	34.7	1	45.7	33	59.0	169	9.8	2700
1.5KE36A	1.5KE36CA	1	30.8	34.2	36	37.8	1	49.9	30	64.3	156	9.9	2500
1.5KE39A	1.5KE39CA	1	33.3	37.1	39	41.0	1	53.9	28	69.7	143	10.0	2400
1.5KE47A	1.5KE47CA	1	40.2	44.7	47	49.4	1	64.8	23.2	84	119	10.1	2050
1.5KE56A	1.5KE56CA	1	47.8	53.2	56	58.8	1	77	19.5	100	100	10.3	1800
1.5KE62A	1.5KE62CA	1	53.0	58.9	62	65.1	1	85	17.7	111	90	10.4	1700
1.5KE68A	1.5KE68CA	1	58.1	64.6	68	71.4	1	92	16.3	121	83	10.4	1550
1.5KE82A	1.5KE82CA	1	70.1	77.9	82	86.1	1	113	13.3	146	69	10.5	1350
1.5KE100A	1.5KE100CA	1	85.5	95.0	100	105	1	137	11	178	56	10.6	1150
1.5KE120A	1.5KE120CA	1	102	114	120	126	1	165	9.1	212	47	10.7	1000
1.5KE150A	1.5KE150CA	1	128	143	150	158	1	207	7.2	265	38	10.8	850
1.5KE180A	1.5KE180CA	1	154	171	180	189	1	246	6.1	317	31.5	10.8	725

Types		$I_{RM} @ V_{RM}$ max		$V_{BR} @ I_R$ min nom max note2				$V_{CL} @ I_{PP}$ max 10/1000 μ s		$V_{CL} @ I_{PP}$ max 8/20 μ s		αT max note3	C typ note4
Unidirectional	Bidirectional	μ A	V	V	V	V	mA	V	A	V	A	10 ⁻⁴ /°C	pF
1.5KE200A	1.5KE200CA	1	171	190	200	210	1	274	5.5	353	28	10.8	675
1.5KE220A	1.5KE220CA	1	188	209	220	231	1	328	4.6	388	26	10.8	625
1.5KE250A	1.5KE250CA	1	213	237	250	263	1	344	5.0	442	23	11	560
1.5KE300A	1.5KE300CA	1	256	285	300	315	1	414	5.0	529	19	11	500
1.5KE350A	1.5KE350CA	1	299	332	350	368	1	482	4.0	618	16	11	430
1.5KE400A	1.5KE400CA	1	342	380	400	420	1	548	4.0	706	14	11	390
1.5KE440A	1.5KE440CA	1	376	418	440	462	1	603	3.5	776	13	11	360

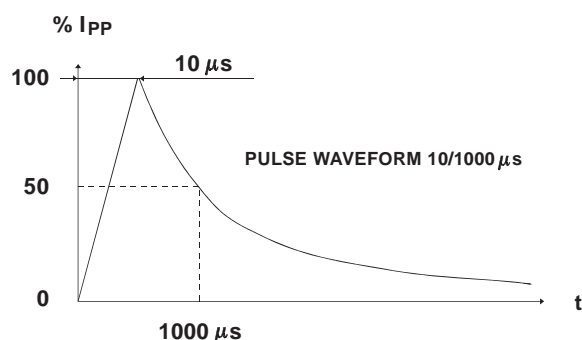

- Note 2 :** Pulse test: $t_p < 50$ ms.
- Note 3 :** $\Delta V_{BR} = \alpha T * (T_{amb} - 25) * V_{BR}(25^\circ C)$.
- Note 4 :** $V_R = 0$ V, $F = 1$ MHz. For bidirectional types, capacitance value is divided by 2.

Fig. 1: Peak pulse power dissipation versus initial junction temperature (printed circuit)

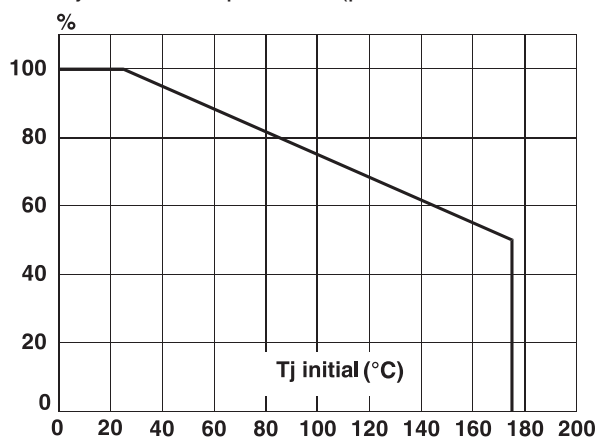

Fig. 2 : Peak pulse power versus exponential pulse duration.

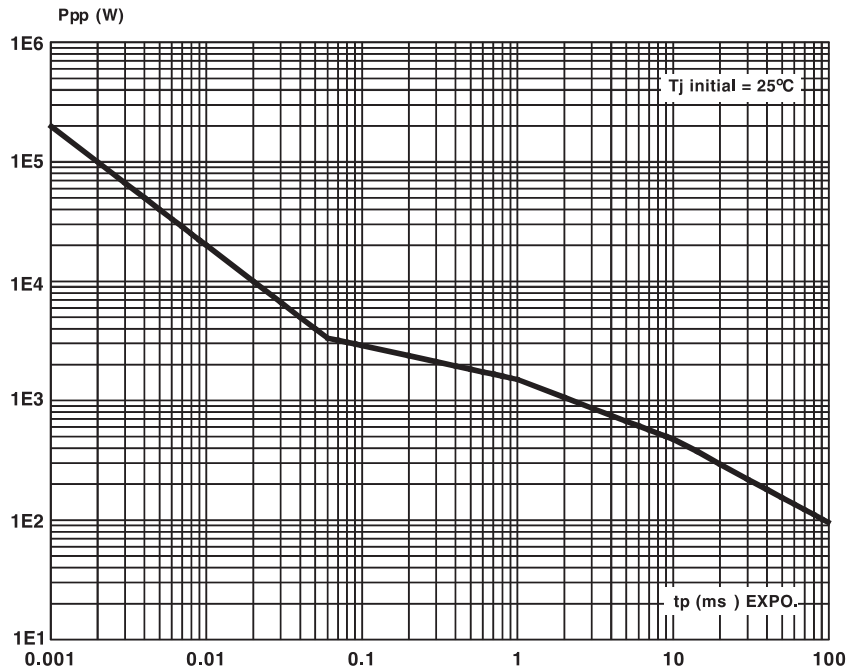
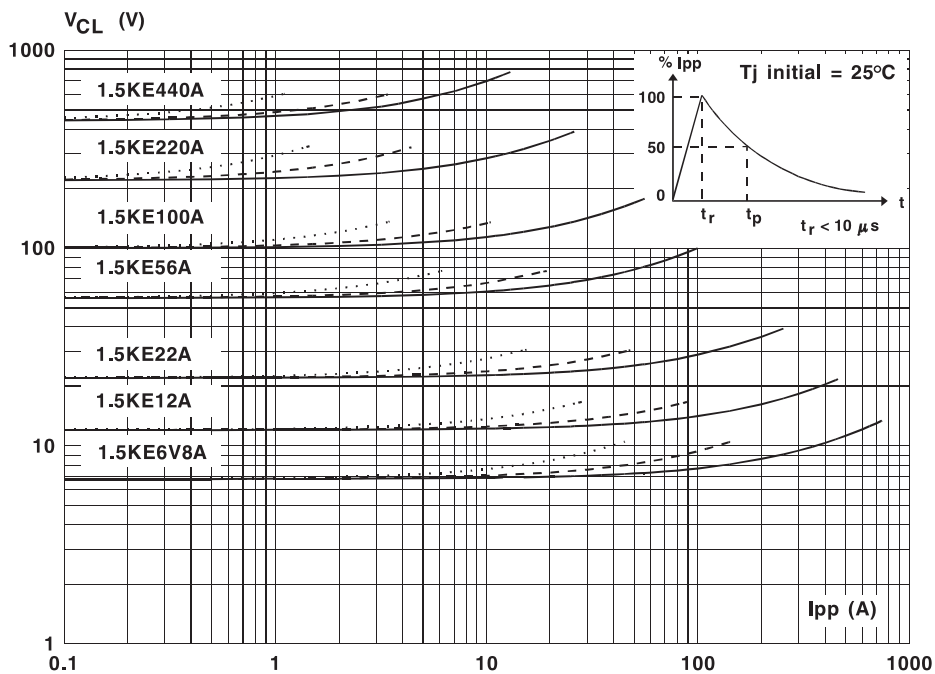

Fig. 3 : Clamping voltage versus peak pulse current.

Exponential waveform: $t_p = 20 \mu s$ _____
 $t_p = 1 ms$ _____
 $t_p = 10 ms$



Note : The curves of the figure 3 are specified for a junction temperature of 25°C before surge.
 The given results may be extrapolated for other junction temperatures by using the following formula :
 $\Delta V_{BR} = \alpha T^* (T_{amb} - 25) * V_{BR}(25^\circ C)$.
 For intermediate voltages, extrapolate the given results.

Fig. 4a : Capacitance versus reverse applied voltage for unidirectional types (typical values).

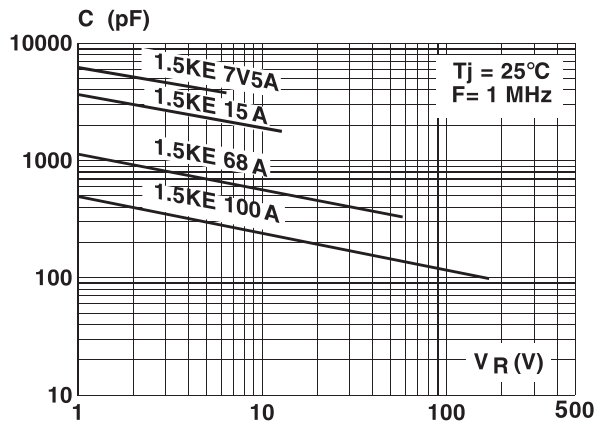

Fig. 4b : Capacitance versus reverse applied voltage for bidirectional types (typical values).

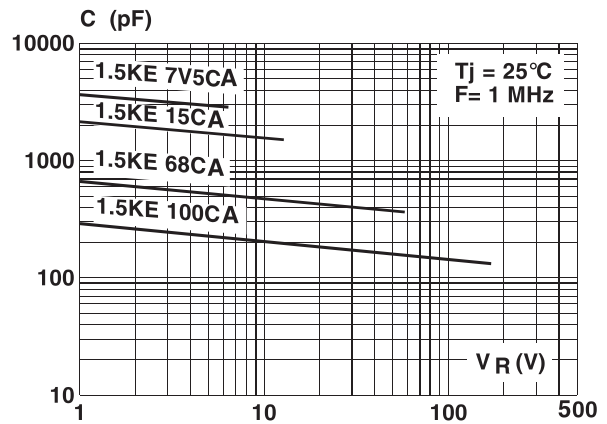

Fig. 5 : Peak forward voltage drop versus peak forward current (typical values for unidirectional types).

Note : Multiply by 2 for units with $V_{BR} > 220\text{ V}$.

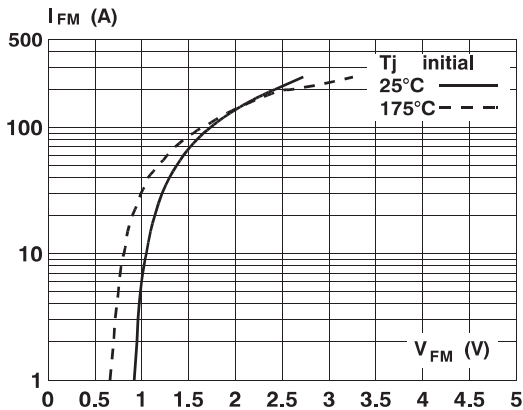

Fig. 6 : Transient thermal impedance junction-ambient versus pulse duration (For FR4 PC Board with $L_{lead} = 10\text{ mm}$).

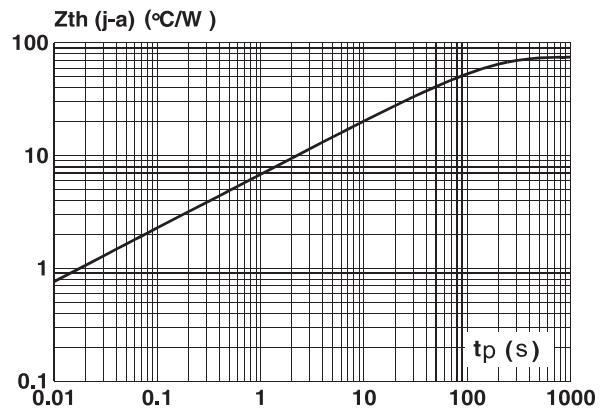
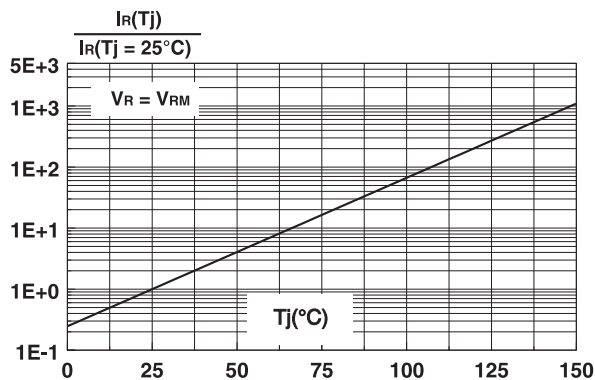
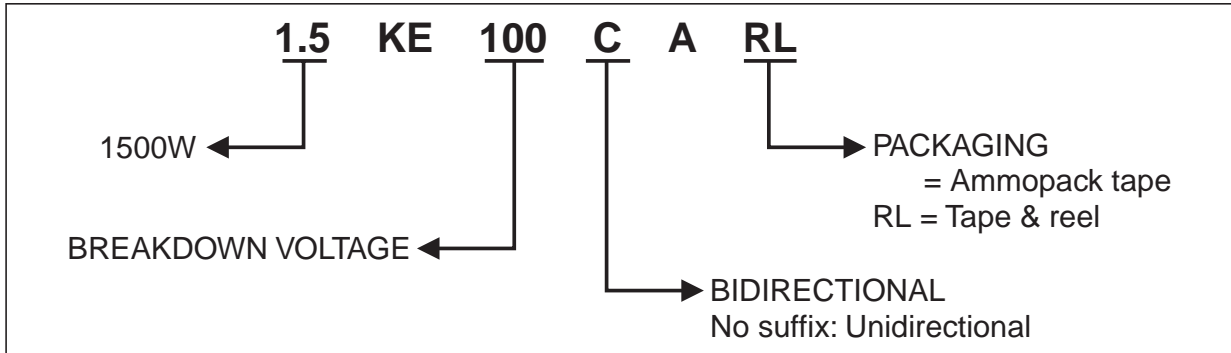

Fig. 7 : Relative variation of leakage current versus junction temperature.



1.5KExx

ORDER CODE



MARKING : Logo, Date Code, Type Code, Cathode Band (for unidirectional types only).

PACKAGE MECHANICAL DATA

DO-201 (Plastic)

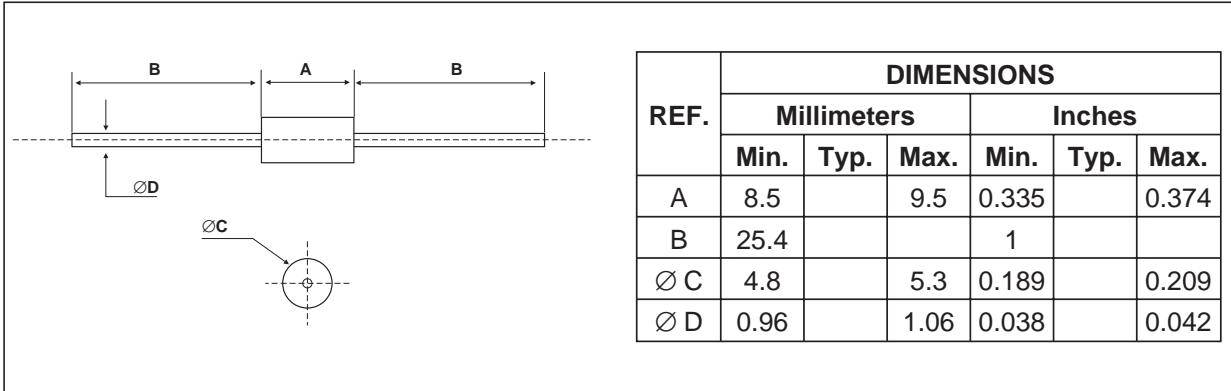

Packaging : standard packaging is in tape and reel.

Weight = 0.876 g.

Information furnished is believed to be accurate and reliable. However, STMicroelectronics assumes no responsibility for the consequences of use of such information nor for any infringement of patents or other rights of third parties which may result from its use. No license is granted by implication or otherwise under any patent or patent rights of STMicroelectronics. Specifications mentioned in this publication are subject to change without notice. This publication supersedes and replaces all information previously supplied. STMicroelectronics products are not authorized for use as critical components in life support devices or systems without express written approval of STMicroelectronics.

The ST logo is a registered trademark of STMicroelectronics

© 2003 STMicroelectronics - Printed in Italy - All rights reserved.

STMicroelectronics GROUP OF COMPANIES

Australia - Brazil - Canada - China - Finland - France - Germany
 Hong Kong - India - Israel - Italy - Japan - Malaysia - Malta - Morocco - Singapore
 Spain - Sweden - Switzerland - United Kingdom - United States.

<http://www.st.com>