



N-Channel Logic Level Enhancement Mode Field Effect Transistor

PRODUCT SUMMARY		
V _{DSS}	ID	R _{DS(on)} (mΩ) Max
30V	83A	5 @ V _{GS} = 10V
		7.5 @ V _{GS} = 4.5V

FEATURES

- Super high dense cell design for extremely low R_{DS(ON)}.
- High power and current handling capability.
- TO-220 & TO-263 package.

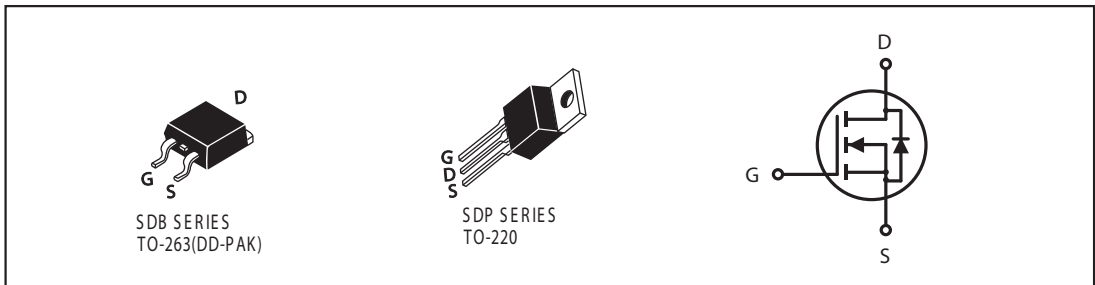

ABSOLUTE MAXIMUM RATINGS (TC=25°C unless otherwise noted)

Parameter	Symbol	Limit	Unit
Drain-Source Voltage	V _{DS}	30	V
Gate-Source Voltage	V _{GS}	±20	V
Drain Current-Continuous @ T _J =125°C -Pulsed ^a	I _D	83	A
	I _{DM}	249	A
Drain-Source Diode Forward Current	I _S	75	A
Maximum Power Dissipation @ T _c =25°C	P _D	75	W
Operating and Storage Temperature Range	T _J , T _{STG}	-65 to 175	°C

THERMAL CHARACTERISTICS

Thermal Resistance, Junction-to-Case	R _{θJC}	2	°C/W
Thermal Resistance, Junction-to-Ambient	R _{θJA}	62.5	°C/W

S DP/B85N03L

查询"9DB85N03L"供应信息

ELECTRICAL CHARACTERISTICS (Tc=25°C unless otherwise noted)

Parameter	Symbol	Condition	Min	Typ	Max	Unit
OFF CHARACTERISTICS						
Drain-Source Breakdown Voltage	BV _{DSS}	V _{GS} =0V, I _D =250uA	30			V
Zero Gate Voltage Drain Current	I _{DSS}	V _{DS} =24V, V _{GS} =0V			10	uA
Gate-Body Leakage	I _{GSS}	V _{GS} =±16V, V _{DS} =0V			±100	nA
ON CHARACTERISTICS^a						
Gate Threshold Voltage	V _{GS(th)}	V _{DS} =V _{GS} , I _D =250uA	1	1.5	3	V
Drain-Source On-State Resistance	R _{DS(ON)}	V _{GS} =10V, I _D =37.5A		4	5	m ohm
		V _{GS} =4.5V, I _D =30A		5.5	7.5	m ohm
On-State Drain Current	I _{D(ON)}	V _{GS} =10V, V _{DS} =10V	75			A
Forward Transconductance	g _{FS}	V _{DS} =10V, I _D =37A		56		S
DYNAMIC CHARACTERISTICS^b						
Input Capacitance	C _{ISS}	V _{DS} =15V, V _{GS} =0V f=1.0MHz		3800		pF
Output Capacitance	C _{OSS}			1750		pF
Reverse Transfer Capacitance	C _{RSS}			390		pF
SWITCHING CHARACTERISTICS^b						
Turn-On Delay Time	t _{D(ON)}	V _{DD} =15V, I _D =1A, V _{GS} =10V V _{GEN} =60 ohm		55		ns
Rise Time	t _r			268		ns
Turn-Off Delay Time	t _{D(OFF)}			363		ns
Fall Time	t _f			233		ns
Total Gate Charge	Q _g	V _{DS} =15V, I _D =85A, V _{GS} =10V		95.2		nC
		V _{DS} =15V, I _D =85A, V _{GS} =4.5V		45		nC
Gate-Source Charge	Q _{gs}	V _{DS} =15V, I _D =85A, V _{GS} =10V		7.2		nC
Gate-Drain Charge	Q _{gd}			5.6		nC

S DP/B85N03L

查询 S DP/B85N03L 供应商

ELECTRICAL CHARACTERISTICS ($T_c=25^\circ\text{C}$ unless otherwise noted)

Parameter	Symbol	Condition	Min	Typ	Max	Unit
DRAIN-SOURCE DIODE CHARACTERISTICS^a						
Diode Forward Voltage	V_{SD}	$V_{GS} = 0V, I_s = 37.5A$		0.9	1.3	V

Notes

- a. Pulse Test: Pulse Width $\leq 300\mu s$, Duty Cycle $\leq 2\%$.
- b. Guaranteed by design, not subject to production testing.

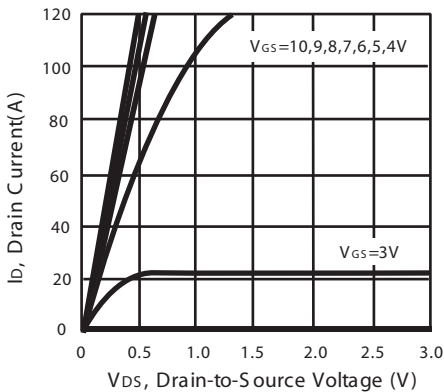

Figure 1. Output Characteristics

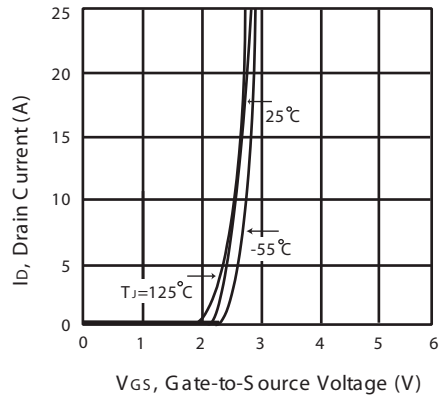

Figure 2. Transfer Characteristics

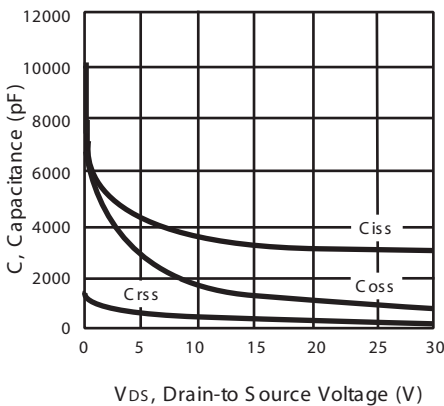

Figure 3. Capacitance

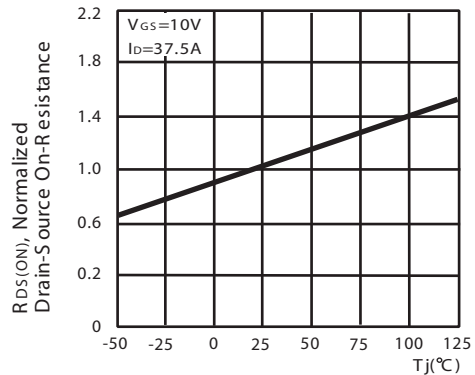

Figure 4. On-Resistance Variation with Temperature

SDP/B85N03L

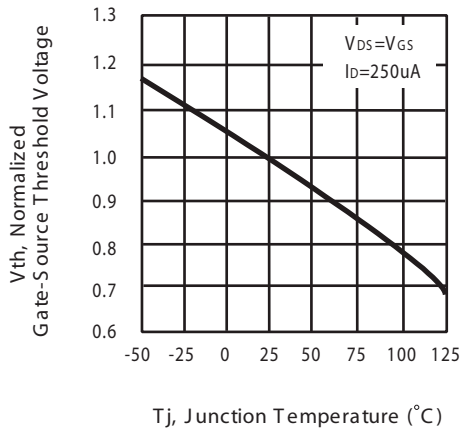

Figure 5. Gate Threshold Variation with Temperature

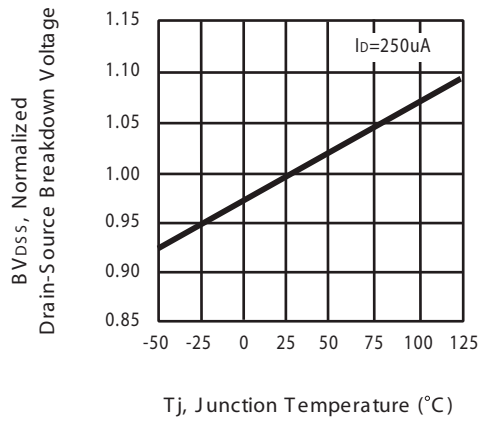

Figure 6. Breakdown Voltage Variation with Temperature

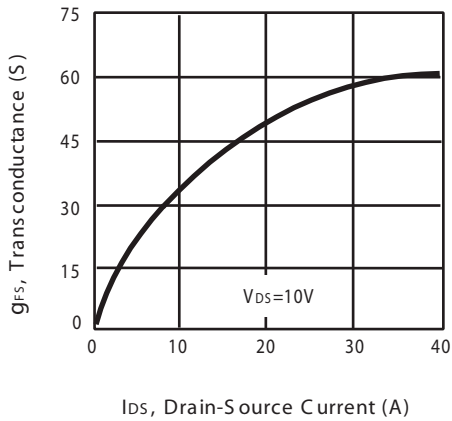

Figure 7. Transconductance Variation with Drain Current

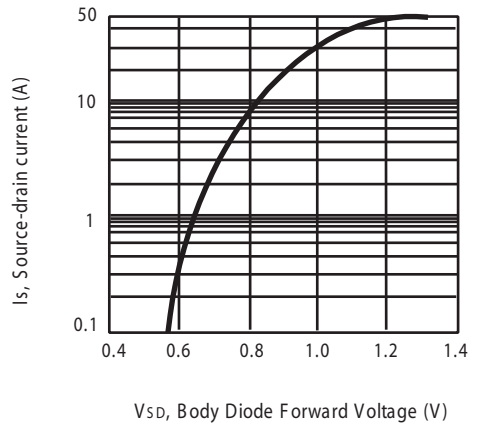

Figure 8. Body Diode Forward Voltage Variation with Source Current

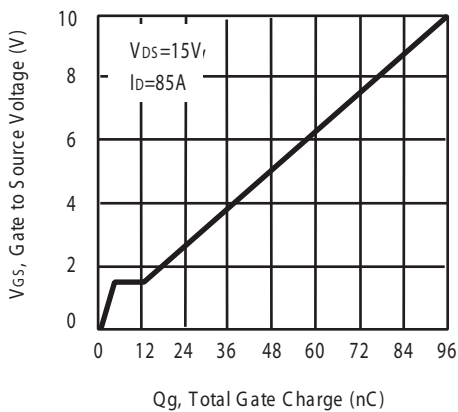

Figure 9. Gate Charge

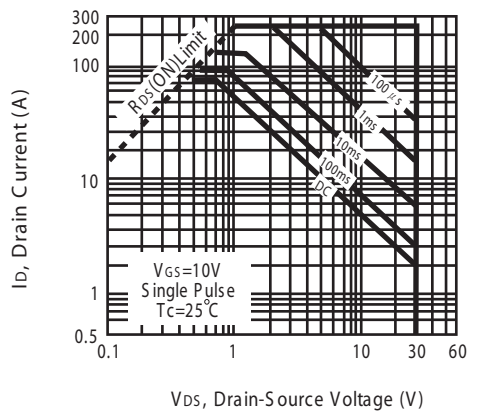

Figure 10. Maximum Safe Operating Area

S DP/B85N03L

[查询“S DP/B85N03L”供应商](#)

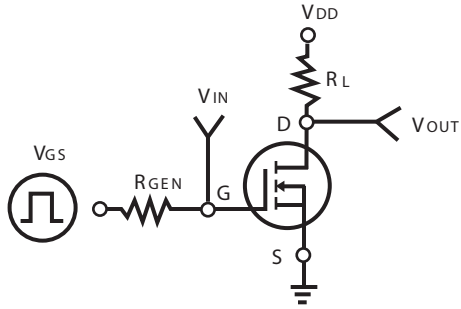

Figure 11. S switching Test Circuit

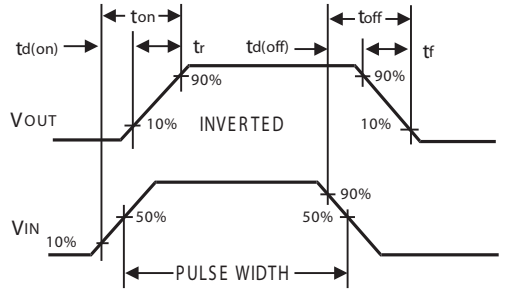

Figure 12. S switching Waveforms

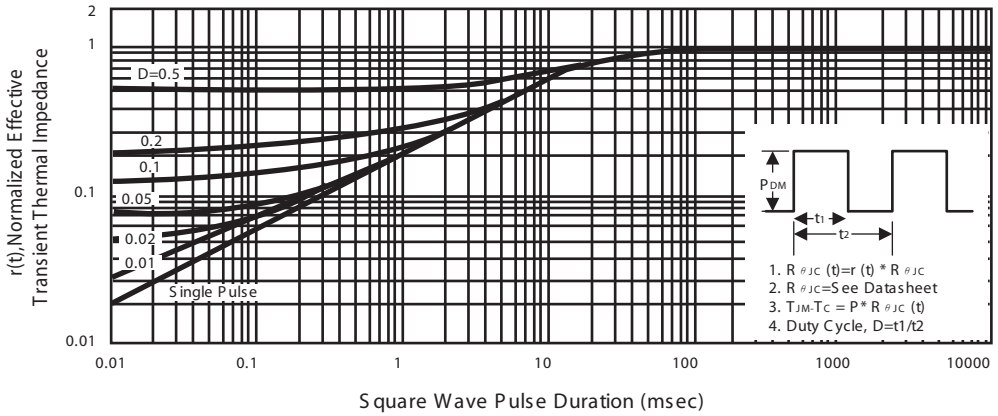

Figure 13. Normalized Thermal Transient Impedance Curve

[查询"SDB85N03L"供应商](#)