

1.2A DC/DC Converter

Features

- 1.2A Constant Output Current
- 93% Efficiency @ input voltage 13V, 350mA, 3-LED
- 9~36V Input Voltage Range
- Hysteretic PFM Improves Efficiency at Light Loads
- Settable Output Current
- Integrated Power Switch
- Full Protection: Thermal/UVLO/Soft Start/LED Open-/Short- Circuit
- Only 4 External Components Required

Surface Mount Device

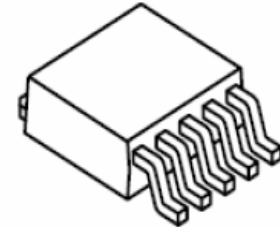

PSD: TO-252-5L

Product Description

The MBI6650 is a high efficiency, constant current, step-down DC/DC converter, designed to deliver constant current to high power LED with only 4 external components. The MBI6650 is specifically designed with hysteretic PFM control scheme to enhance the efficiency up to 93%. Output current of the MBI6650 can be programmed by an external resistor, and LED dimming can be controlled via pulse width modulation (PWM) through DIM pin. In addition, the embedded soft start function eliminates the inrush current while the power is on. The MBI6650 also features under voltage lock out (UVLO), over temperature protection, LED open-circuit protection and LED short-circuit protection to protect IC from being damaged.

Additionally, to ensure the system reliability, the MBI6650 is built with the thermal protection (TP) function and a thermal pad. The TP function protects IC from over temperature (140°C). Also, the thermal pad enhances the power dissipation. As a result, a large amount of current can be handled safely in one package.

Applications

- Signage and Decorative LED Lighting
- Automotive LED Lighting
- High Power LED Lighting
- Constant Current Source

查询"MBI6650PSD"供应商
Typical Application Circuit

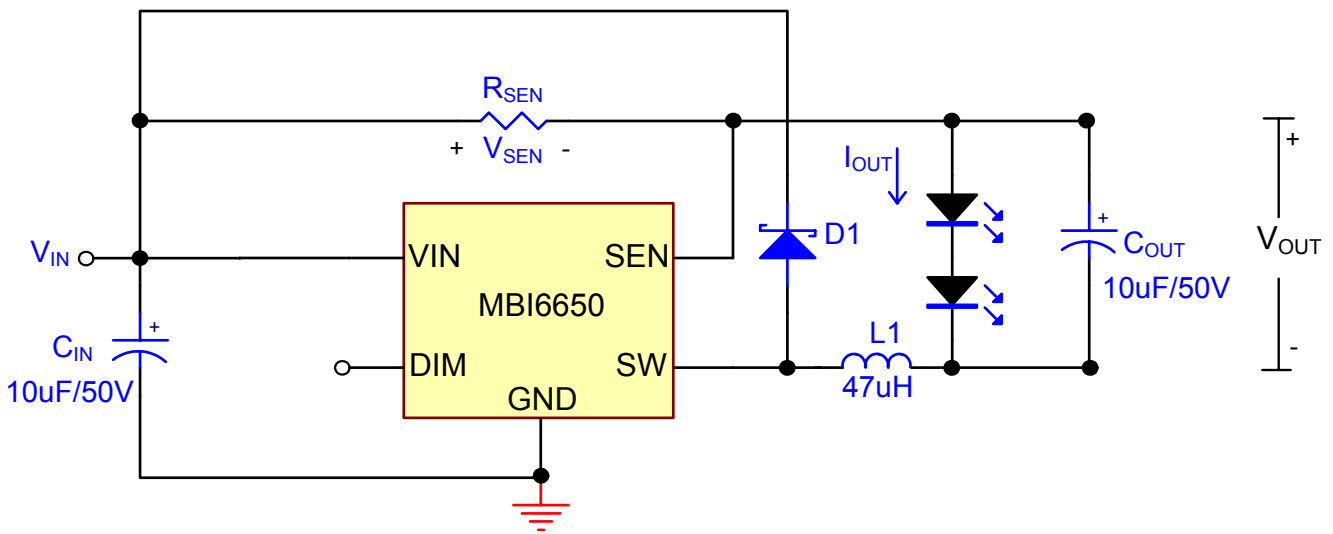

C_{IN}: VISHAY, 293D106X9050D2TE3, D case Tantalum Capacitor
C_{OUT}: VISHAY, 293D106X9050D2TE3, D case Tantalum Capacitor
L1: GANG SONG, GSRH8D43-470M
D1: ZOWIE, SSCD206

Figure 1

Functional Diagram

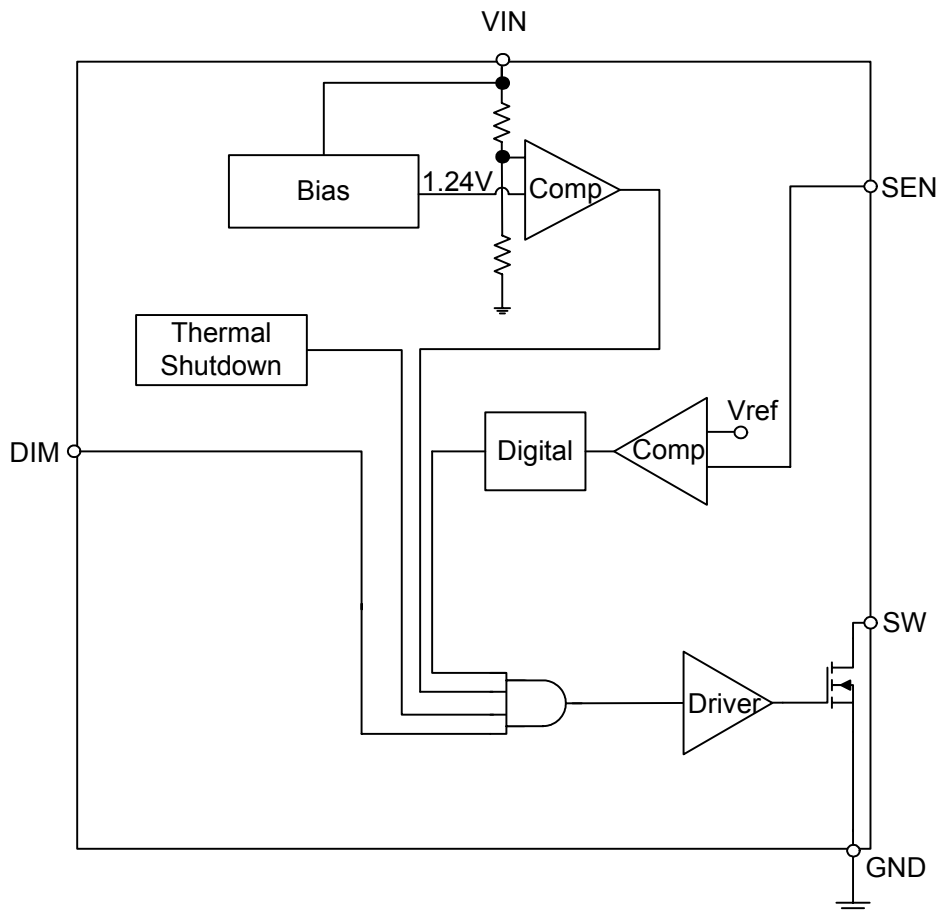
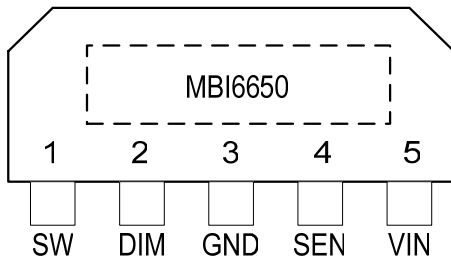

Figure 2

Pin Configuration [查看器件供应商](#)



Pin Description

Pin Name	Function
GND	Ground terminal for control logic and current sink
SW	Switch output terminal
DIM	Dimming control terminal
SEN	Output current sense terminal
VIN	Supply voltage terminal
Thermal Pad	Power dissipation terminal connected to GND*

*To eliminate the noise influence, the thermal pad is suggested to be connected to GND on PCB.

In addition, the desired thermal conductivity will be improved, when a heat-conducting copper foil on PCB is soldered with thermal pad.

Maximum Ratings

Operation above the maximum ratings may cause device failure. Operation at the extended periods of the maximum ratings may reduce the device reliability.

Characteristic	Symbol	Rating	Unit
Supply Voltage	V_{IN}	0~40	V
Output Current	I_{OUT}	1.2	A
Sustaining Voltage at SW pin	V_{SW}	-0.5~45	V
GND Terminal Current	I_{GND}	1.2	A
Power Dissipation (On 4 Layer PCB, $T_a=25^{\circ}C$)*	P_D	3.80	W
Thermal Resistance (By simulation, on 4 Layer PCB)	$R_{th(j-a)}$	32.9	$^{\circ}C/W$
Empirical Thermal Resistance (On 4 Layer PCB, $T_a=25^{\circ}C$)*		50.54	
Operating Junction Temperature	$T_{j,max}$	125	$^{\circ}C$
Operating Temperature	T_{opr}	-40~+85	$^{\circ}C$
Storage Temperature	T_{stg}	-55~+150	$^{\circ}C$

*The PCB area is 7 times larger than that of IC's, and the heat sink area of MBI6650 is 109mm². Please refer to Figure 38 for the PCB layout.

Electrical Characteristics

(Test condition: $V_{IN}=12V$, $L1=47\mu H$, $C_{IN}=C_{OUT}=10\mu F$, $T_A=25^\circ C$; unless otherwise specified; refer to test circuit (a))

Characteristics		Symbol	Condition	Min.	Typ.	Max.	Unit
Supply Voltage		V_{IN}	-	9	-	36	V
Supply Current		I_{IN}	$V_{IN}=9V\sim 36V$	-	1	4	mA
Output Current		I_{OUT}	-	350	-	1200	mA
Output Current Accuracy		dI_{OUT}/I_{OUT}	$150mA \leq I_{OUT} \leq 750mA$,	-	± 5	± 10	%
			$75mA \leq I_{OUT} \leq 1200mA$,	-	± 5	± 10	
SW Dropout Voltage		ΔV_{SW}	$I_{OUT}=1.2A$	-	0.3	0.6	V
Line Regulation		$\%/\Delta V_{IN}$	$9V \leq V_{IN} \leq 36V$, $V_{OUT}=3.6V$, $I_{OUT}=350mA$	-	± 0.30	± 0.37	$\%/V$
Load Regulation		$\%/\Delta V$	$V_{IN}=24V$, $I_{OUT}=350mA$, $3.6V \leq V_{OUT} \leq 18V$	-	± 0.24	± 1.38	$\%/V$
			$V_{IN}=24V$, $I_{OUT}=700mA$, $3.6V \leq V_{OUT} \leq 18V$	-	± 0.24	± 1.50	
			$V_{IN}=24V$, $I_{OUT}=1200mA$, $3.6V \leq V_{OUT} \leq 18V$	-	± 0.24	± 1.80	
Efficiency		-	$V_{IN}=13V$, $I_{OUT}=350mA$, $V_{OUT}=10.8V$	-	93	-	%
Input Voltage	"H" level	V_{IH}	-	3.5	-	-	V
	"L" level	V_{IL}	-	-	-	1.5	V
Switch ON resistance		$R_{ds(on)}$	$V_{IN}=12V$; refer to test circuit (b)	-	0.8	1.1	Ω
CURRENT SENSE							
Regulated R_{SEN} Voltage		V_{SEN}	Production code "A" *	-	0.28	-	V
		V_{SEN}	Production code "B" *	-	0.33	-	
THERMAL OVERLOAD							
Thermal Shutdown Threshold		T_{SD}	-	+130	+140	+155	$^\circ C$
Thermal Shutdown Hysteresis		T_{SD-HYS}	-	40	45	55	$^\circ C$
UNDER VOLTAGE LOCK OUT							
UVLO Voltage		-	$T_A=-40\sim 85^\circ C$	6.6	7.4	7.9	V
UVLO Hysteresis		-	-	0.5	0.6	1	V
Start Up Voltage		-	-	7.3	8.0	8.8	V
DIMMING							
Rise Time of Output Current		t_r	$V_{OUT}=3.6V$, $I_{OUT}=350mA$, $f_{DIM}=1kHz$, Duty $_{DIM}=50\%$	-	140	-	μs
Fall Time of Output Current		t_f	$V_{OUT}=3.6V$, $I_{OUT}=350mA$, $f_{DIM}=1kHz$, Duty $_{DIM}=50\%$	-	160	-	μs

*Refer to Product Top-Mark Information.

Test Circuit for Electrical Characteristics

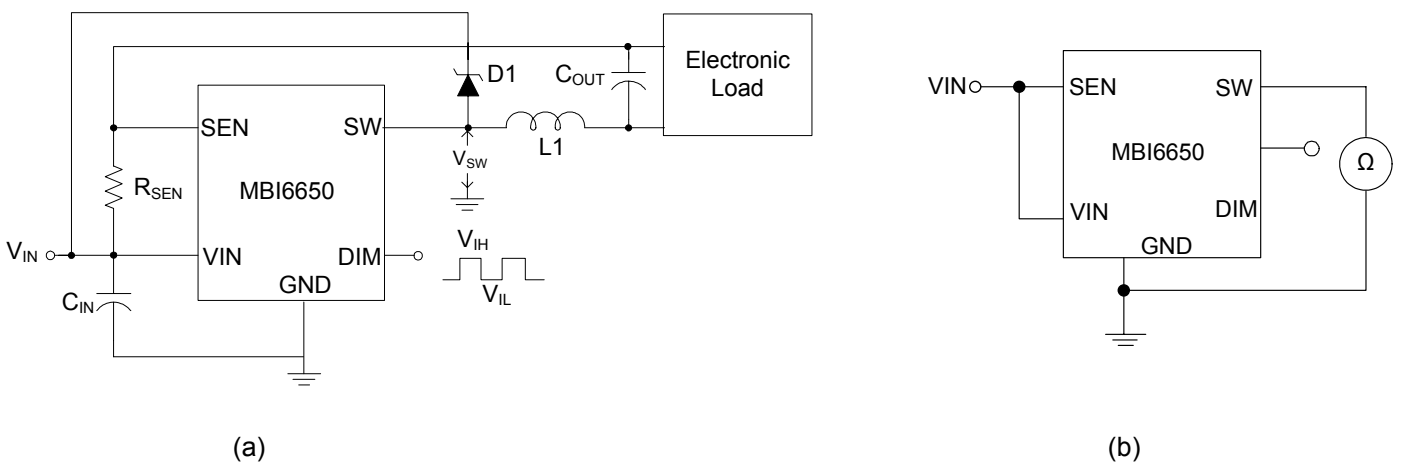

Figure 3

Typical Performance Characteristics

Please refer to Typical Application Circuit, $V_{IN}=12V$, $L1=47\mu H$, $C_{IN}=C_{OUT}=10\mu F$, $T_A=25^\circ C$, unless otherwise specified.

1-LED $V_F=3.6V$; 2-LED $V_F=7.2V$; 3-LED $V_F=10.8V$; 4-LED $V_F=14.4V$; 5-LED $V_F=18V$

1. Efficiency vs. Input Voltage at Various Load Current

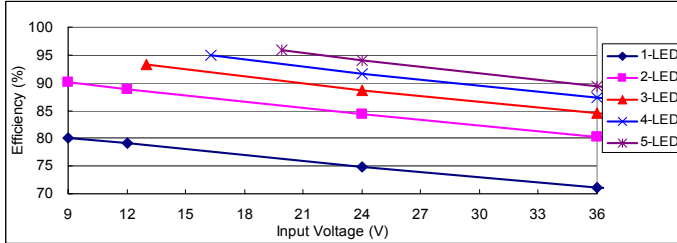

Figure 4. Efficiency vs. V_{IN} @ 350mA, $L1=47\mu H$

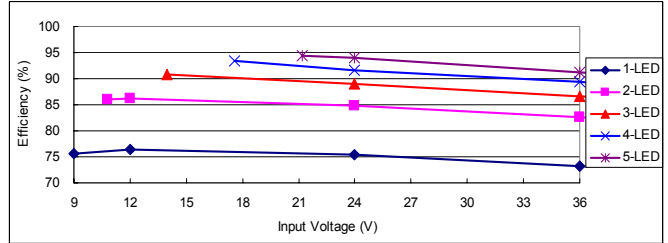

Figure 5. Efficiency vs. V_{IN} @ 700mA, $L1=47\mu H$

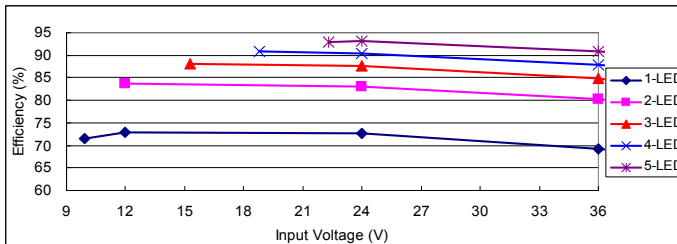

Figure 6. Efficiency vs. V_{IN} @ 1000mA, $L1=47\mu H$

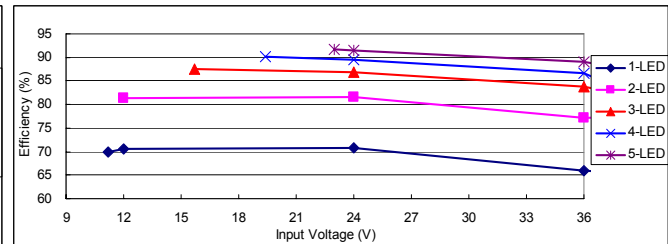

Figure 7. Efficiency vs. V_{IN} @ 1200mA, $L1=47\mu H$

2. Line Regulation

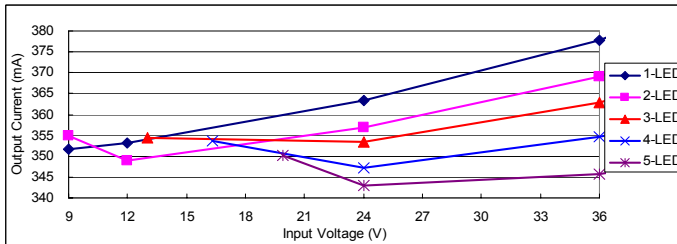

Figure 8. Line regulation @ 350mA, $L1=47\mu H$

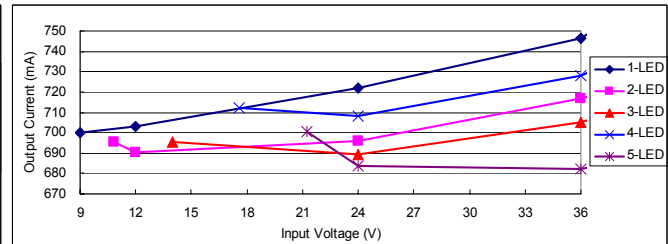

Figure 9. Line regulation @ 700mA, $L1=47\mu H$

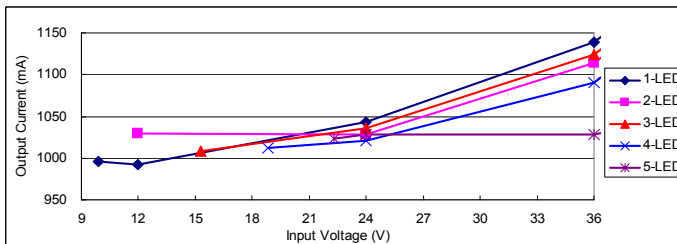

Figure 10. Line regulation @ 1000mA, $L1=47\mu H$

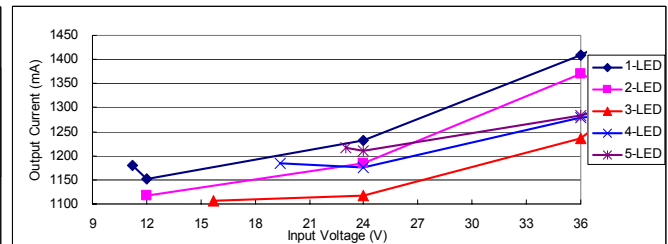

Figure 11. Line regulation @ 1200mA, $L1=47\mu H$

3. Load Regulation

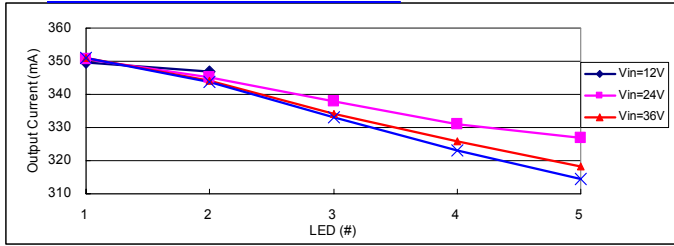

Figure 12. Load regulation @ 350mA, L1=47uH

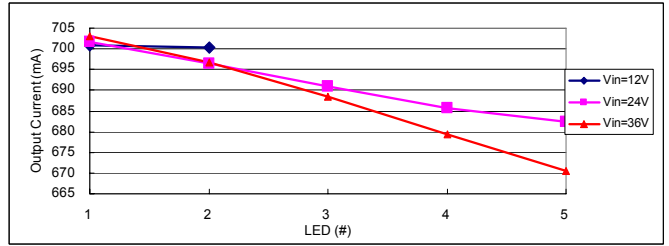

Figure 13. Load regulation @ 700mA, L1=47uH

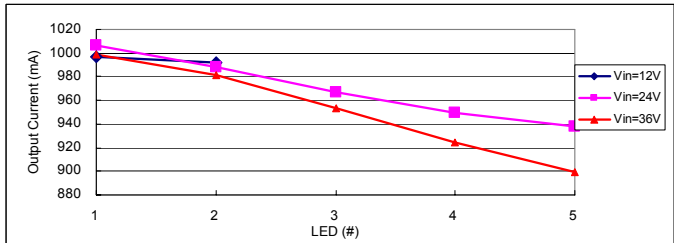

Figure 14. Load regulation @ 1000mA, L1=47uH

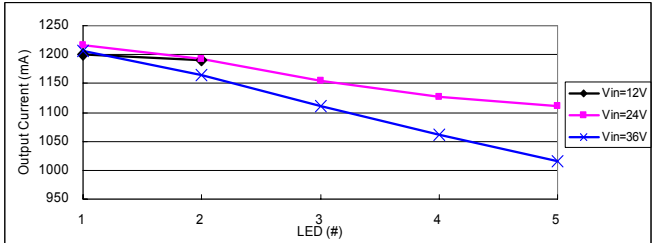

Figure 15. Load regulation @ 1200mA, L1=47uH

4. Switching Frequency

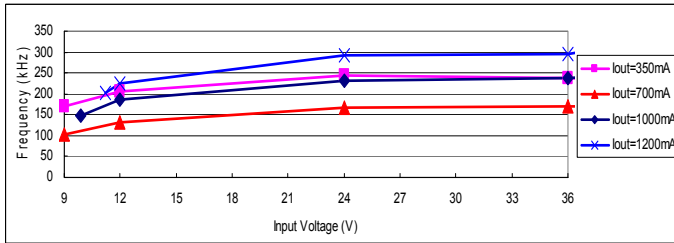

Figure 16. Switching frequency @ 1-LED, L1=47uH

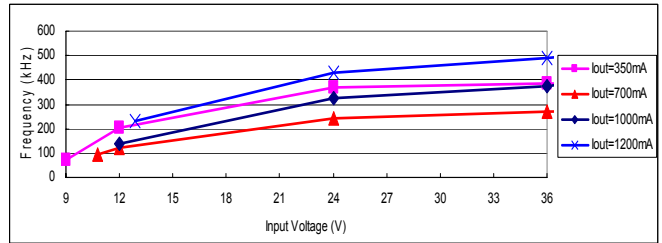

Figure 17. Switching frequency @ 2-LED, L1=47uH

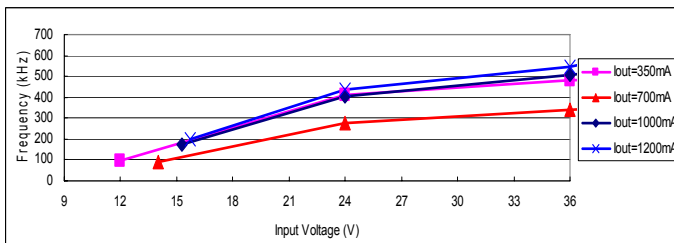

Figure 18. Switching frequency @ 3-LED, L1=47uH

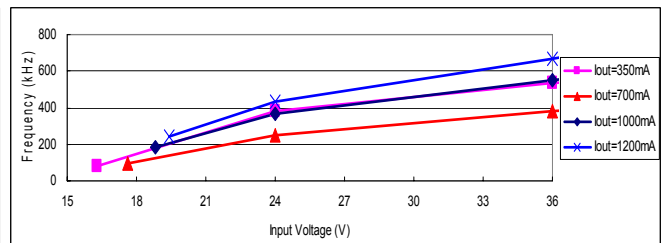

Figure 19. Switching frequency @ 4-LED, L1=47uH

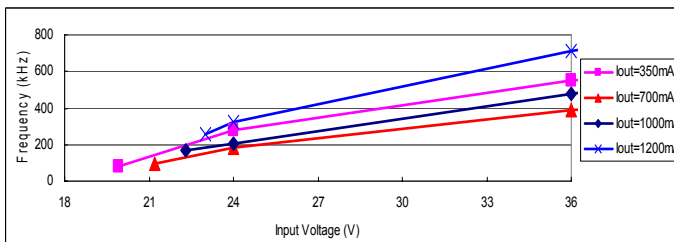

Figure 20. Switching frequency @ 5-LED, L1=47uH

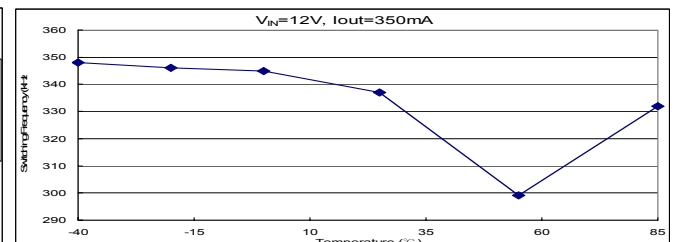

Figure 21. Switching frequency vs. temperature

5. Miscellaneous [查询"MBI6650PSD"供应商](#)

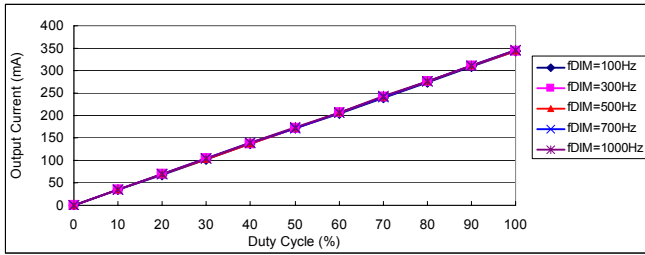

Figure 22. Output current vs. DIM duty cycle @ 1-LED,
 $I_{OUT}=350mA$

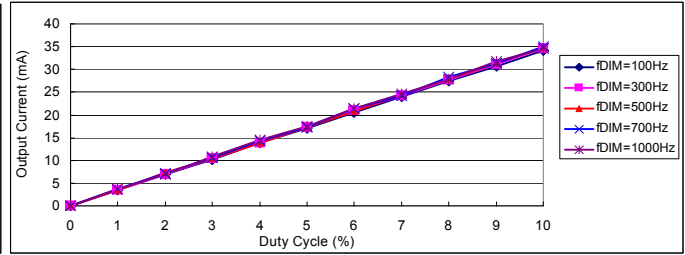

Figure 23. Output current vs. DIM duty cycle @ 1-LED,
 $I_{OUT}=350mA$

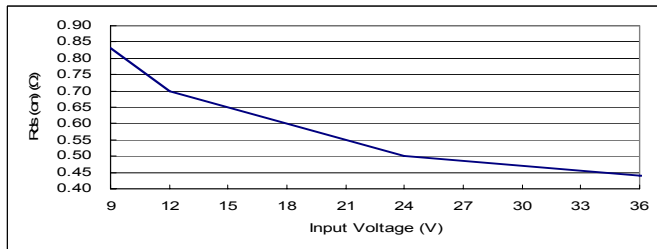

Figure 24. $R_{ds(on)}$ vs. V_{IN}

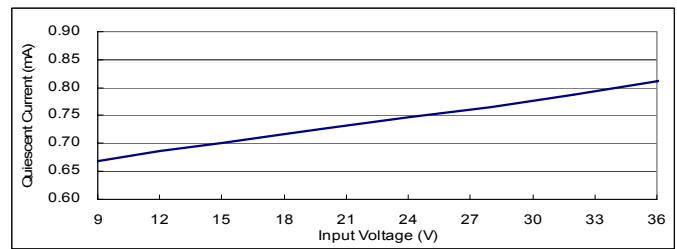

Figure 25. Quiescent current vs. V_{IN}

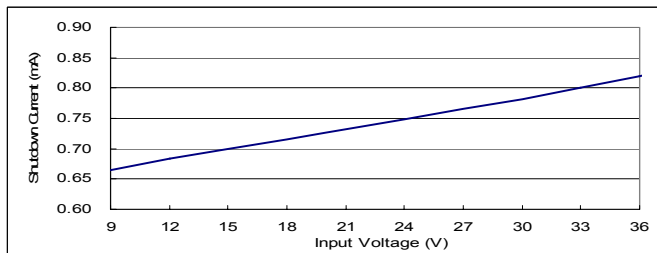

Figure 26. Shutdown current vs. V_{IN}

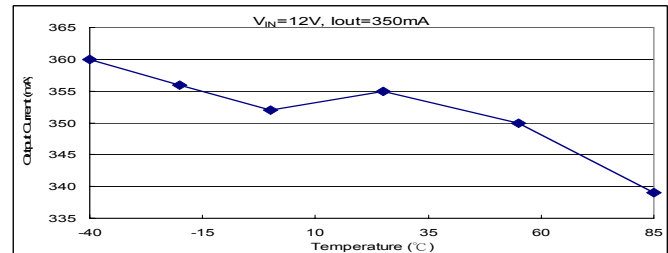

Figure 27. Output current vs. temperature

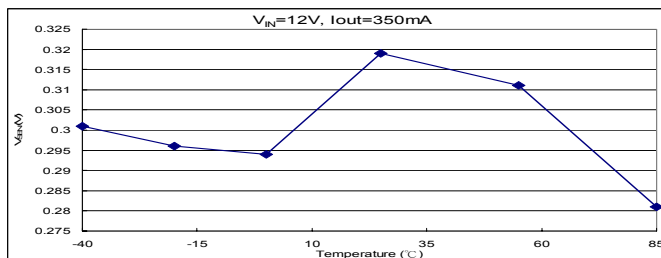

Figure 28. V_{SEN} vs. temperature

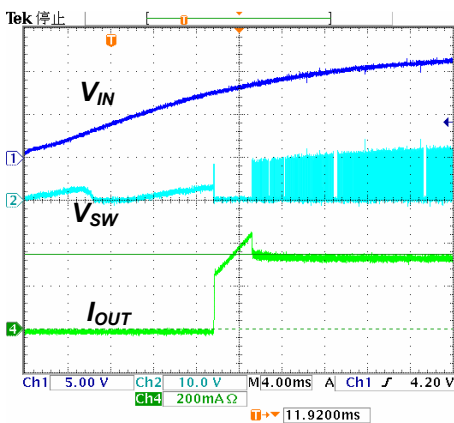

Figure 29. Start-up waveform @ $V_{OUT}=7.2V$, $I_{OUT}=350mA$

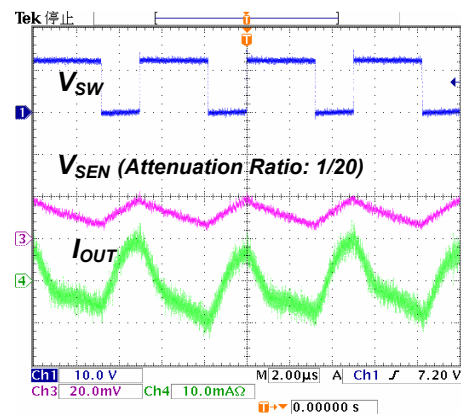

Figure 30. Switching waveform @ $V_{OUT}=3.6V$,
 $I_{OUT}=350mA$

查询"MBI6650PSD"供应商

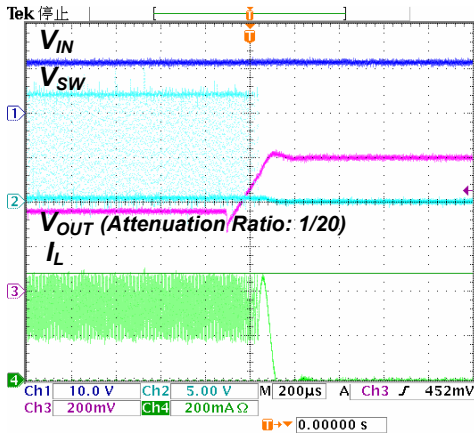

Figure 31. Open-circuit protection waveform
@ I_{OUT}=350mA

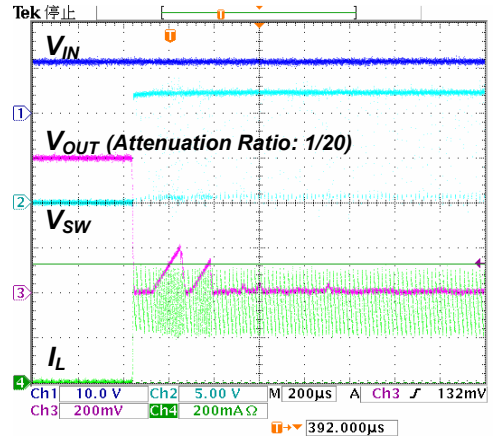

Figure 32. Short -circuit protection waveform
@I_{OUT}=350mA

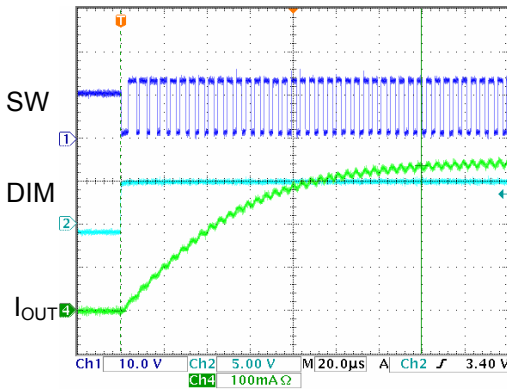

Figure 33. Rise time of output current @ 1-LED,
I_{OUT}=350mA, tr=140µs

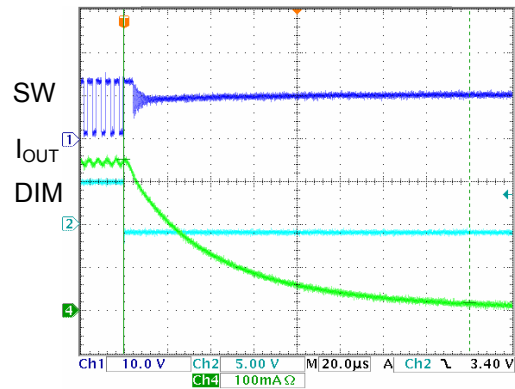

Figure 34. Fall time of output current @ 1-LED,
I_{OUT}=350mA, tr=160µs

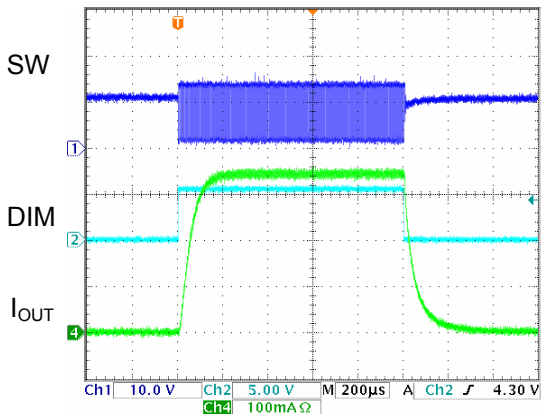

Figure 35. Dimming waveform @ 1-LED,
I_{OUT}=350mA, f_{DIM}=100Hz, Duty_{DIM}=10%

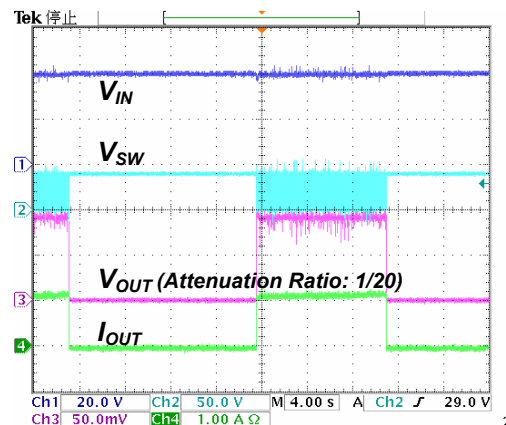

Figure 36. Thermal protection

查询"MBI6650PSD"供应商

Application Information

The MBI6650 is embedded with all the features to implement a simple, cost effective, and high efficient buck converter to drive more than 1A of loading. The MBI6650 contains an N-Channel switch, is easy to implement, and is available in the thermally enhanced TO252-5L package. The MBI6650's operation is based on a hysteretic PFM control scheme resulting in the operating frequency remaining relatively constant with load and input voltage variations. The hysteretic PFM control requires no loop compensation resulting in very fast load transient response and achieving excellent efficiency performance at light loading.

Setting Output Current

The output current (I_{OUT}) is set by an external resistor, R_{SEN} . The relationship between I_{OUT} and R_{SEN} is as below; for production code information, please refer to Product Top-Mark Information:

For production code A,

$$V_{SEN}=0.28V;$$

$$R_{SEN}=(V_{SEN}/I_{OUT})=(0.28V/I_{OUT});$$

$$I_{OUT}=(V_{SEN}/R_{SEN})=(0.28V/R_{SEN})$$

where R_{SEN} is the resistance of the external resistor connected to SEN terminal and V_{SEN} is the voltage of external resistor. The magnitude of current (as a function of R_{SEN}) is around 1000mA at 0.28Ω.

For production code B,

$$V_{SEN}=0.33V;$$

$$R_{SEN}=(V_{SEN}/I_{OUT})=(0.33V/I_{OUT});$$

$$I_{OUT}=(V_{SEN}/R_{SEN})=(0.33V/R_{SEN})$$

where R_{SEN} is the resistance of the external resistor connected to SEN terminal and V_{SEN} is the voltage of external resistor. The magnitude of current (as a function of R_{SEN}) is around 1000mA at 0.33Ω.

Minimum Input Voltage

The minimum input voltage is the sum of the voltage drops on R_{SEN} , R_S , DCR of L1, $R_{ds(on)}$ of internal MOSFET and the total forward voltage of LEDs. The dynamic resistance of LED, R_S , is the inverse of the slope in linear forward voltage model for LED. This electrical characteristic can be provided by LED manufacturers. The equivalent impedance of the MBI6650 application circuit is shown as in Figure 36. As the input voltage is smaller than minimum input voltage, which is pointed out by MBI6650 Design Tool, the output current will be larger than the present output current, and is limited to 1.3 times of preset one. For detailed information, please refer to the *MBI6650 Application Note V1.00*.

[查询"MBI6650PSD"供应商](#)

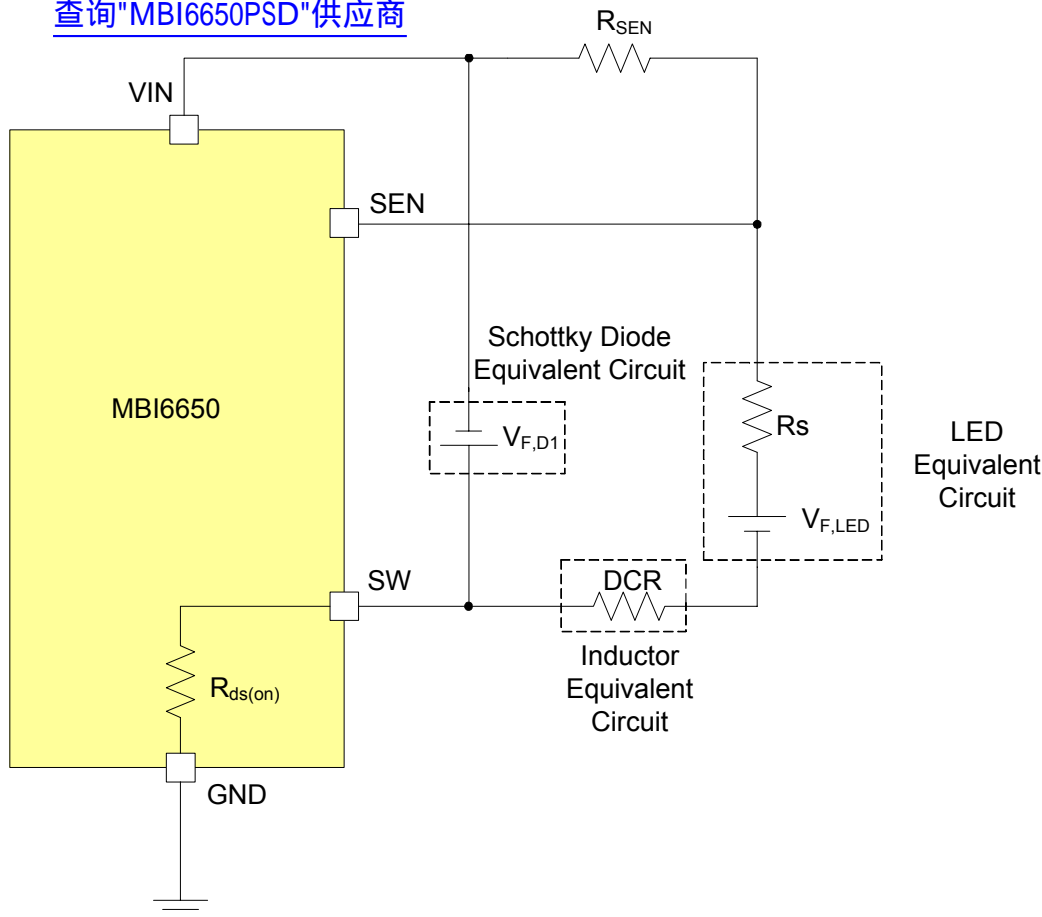

Figure 37. The equivalent impedance in a MBI6650 application circuit

Dimming

The dimming of LEDs can be performed by applying PWM signals to DIM pin. A logic low (below 1.5V) at DIM will disable the internal MOSFET and shut off the current flow to the LED array. An internal pull-up circuit ensures that the MBI6650 is on when DIM pin is unconnected, eliminating the need for an external pull-up resistor.

LED Open-Circuit Protection

When any LED connected to the MBI6650 is open-circuit, output current of the MBI6650 will be turned off.

LED Short-Circuit Protection

When any LED connected to the MBI6650 is short-circuit, output current of the MBI6650 will still be limited to its preset value.

Under Voltage Lock Out Protection

When the voltage at VIN of the MBI6650 is below 7.4V, output current of the MBI6650 will be turned off. When VIN voltage of the MBI6650 resumes to 8.0V, output current of the MBI6650 will be turned on again.

Internal Soft Start Protection

With embedded soft start function inside the MBI6650, output ripple of the MBI6650 can be eliminated.

TP Function (Thermal Protection)

[查询 MBI6650 \(PSD\) 供应商](#)

When the junction temperature exceeds the threshold, T_x (140°C), TP function turns off the output current. Thus, the junction temperature starts to decrease. As soon as the temperature is below 140°C, the output current will be turned on again. The on-state and off-state switch are at a high frequency; thus, the blinking is imperceptible. However, the average output current is limited, and therefore, the driver is protected from being overheated.

Inductor Selection

The inductance is determined by two factors: the switching frequency and the inductor ripple current. The calculation of the inductance, L_1 , can be described as

$$L_1 > (V_{IN} - V_{OUT} - V_{SEN} - (R_{ds(on)} \times I_{OUT})) \times \frac{D}{f_{SW} \times \Delta I_L}$$

where

$R_{ds(on)}$ is the on-resistance of internal MOSFET of the MBI6650. The typical is 0.8Ω at 12V_{IN}.

D is the duty cycle of the MBI6650, $D=V_{OUT}/V_{IN}$.

f_{SW} is the switching frequency of the MBI6650.

ΔI_L is the ripple current of inductor, $\Delta I_L=(1.3 \times I_{OUT})-(0.7 \times I_{OUT})=0.6 \times I_{OUT}$.

When selecting an inductor, the inductance is not the only factor to affect the performance of module, but the saturation current also needs to be considered. In general, it is recommended to choose an inductor with 1.5 times of LED current as the saturation current. Also, the larger inductance gains the better line/load regulation. However, when at the same inductor size, the inductance and saturation current becomes a trade-off. An inductor with shield is recommended to reduce the EMI interference, but this is another trade-off with heat dissipation.

Schottky Diode Selection

The MBI6650 needs a flywheel diode, D_1 , to carry the inductor current when the MOSFET is off. The recommended flywheel diode is schottky diode with low forward voltage for better efficiency. Two factors determine the selection of schottky diode. One is the maximum reverse voltage, and the recommended rated voltage of the reverse voltage is at least 1.5 times of input voltage. The other is the maximum forward current, which works when the MOSFET is off, and the recommended forward current is 1.5 times of output current.

Input Capacitor Selection

The input capacitor, C_{IN} , can supply pulses of current for the MBI6650 when the MOSFET is on, and C_{IN} is charged by input voltage when the MOSFET is off. As the input voltage is lower than the tolerable input voltage, the internal MOSFET of the MBI6650 becomes constantly “on”, and the LED current is limited to 1.3 times of normal current. Therefore the key factor in input capacitor selection is the minimum input voltage, which can be tolerated. The minimum input capacitor ($C_{IN, MIN}$) can be calculated by the following equation

$$C_{IN, MIN} = 1.3 \times I_{OUT} \times \frac{D \times T_S}{V_{IN} - V_{IN, MIN}}$$

where

$V_{IN, MIN}$ is the tolerable input voltage, $V_{IN, MIN}=V_{IN}-V_{OUT, MAX}$.

The rated voltage of input capacitor should be at least 1.5 times of input voltage. A tantalum or ceramic capacitor can be used as an input capacitor. The advantages of tantalum capacitor are high capacitance and low ESR. The

advantages of ceramic capacitor are high frequency characteristic, small size and low cost. Users can choice an appropriate one for applications.

Output Capacitor Selection (Optional)

A capacitor paralleled with cascaded LED can reduce the LED ripple current and allow the use of smaller inductance.

PCB Layout Consideration

To enhance the efficiency and stabilize the system, careful considerations of PCB layout is important. There are several factors to be considered.

1. Keep a complete ground area is helpful to eliminate the switching noise.
2. Keep the IC's GND pin and the ground leads of input and output filter capacitors less than 5mm.
3. Maximize output power efficiency and minimize output ripple voltage, use a ground plane and solder the IC's GND pin directly to the ground plane.
4. Stabilize the system, the heat sink of the MBI6650 is recommended to connect to ground plane directly.
5. Enhance the heat dissipation, the area of ground plane, which IC's heat sink is soldered on, should be as large as possible.
6. The input capacitor should be placed to IC's VIN pin as close as possible.
7. The area, which is comprised by IC's SW pin, schottky diode and inductor, should be wide and short.
8. The path, which flows large current, should be wide and short to eliminate the parasite element.
9. When SW is on/off, the direction of power loop should keep the same way to enhance the efficiency. The sketch is shown as Figure 38.

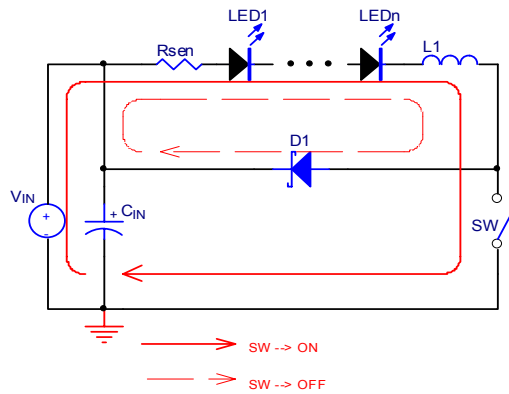

Figure 38. Power loop of MBI6650

PCB Layout

Figure 39 is the recommended layout diagram of the MBI6650.

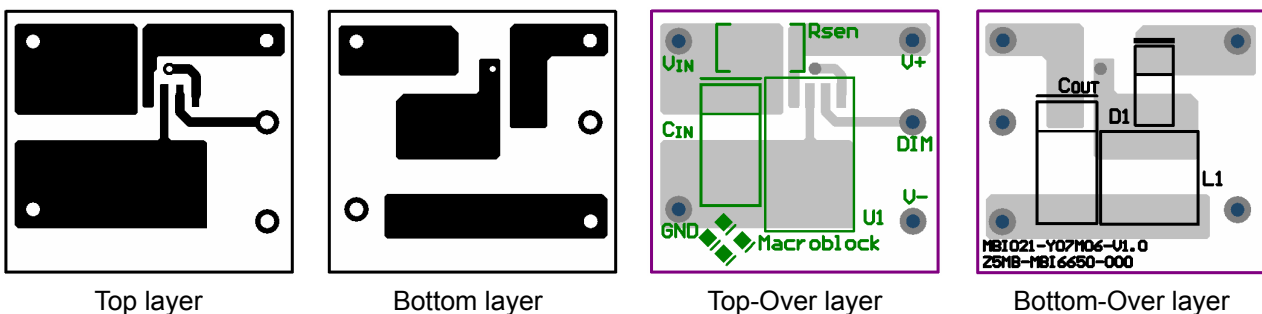
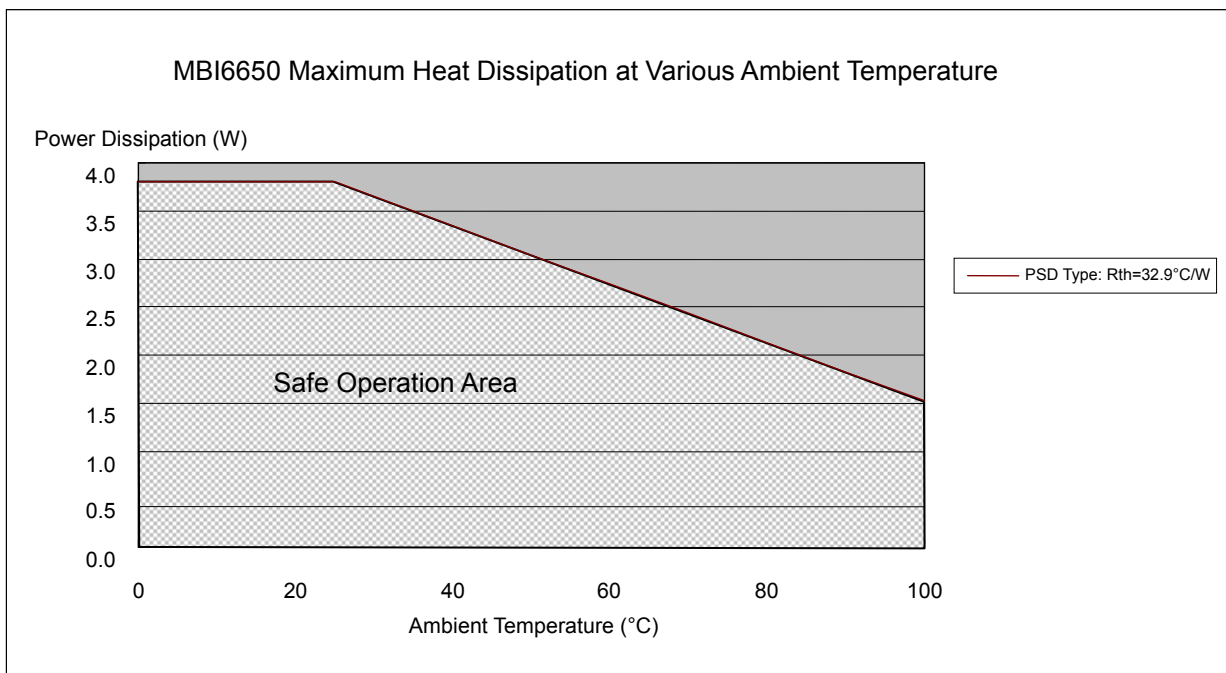

Figure 39. The layout diagram of the MBI6650

查询"MBI6650PSD"供应商
Package Power Dissipation (PD)

The maximum power dissipation, $P_D(max)=(T_j-T_a)/R_{th(j-a)}$, decreases as the ambient temperature increases.



[查询"MBI6650PSD"供应商](#)

Outline Drawing

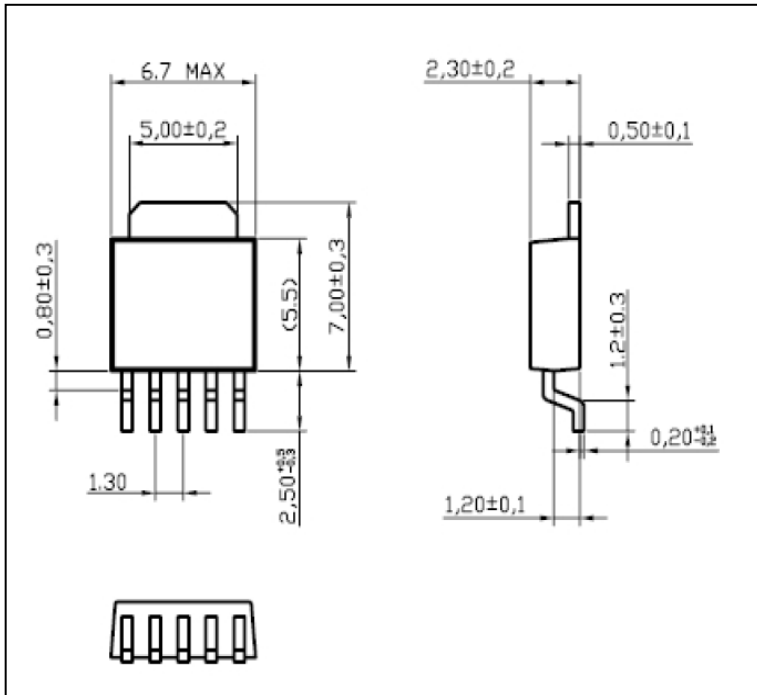

MBI6650PSD Outline Drawing

Note: The unit for the outline drawing is mm.

Product Top Mark Information

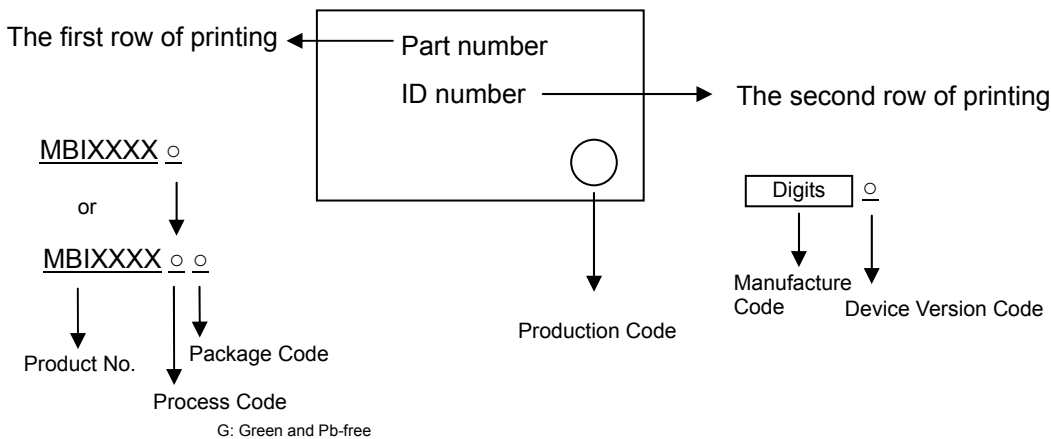

Product Revision History

Datasheet version	Device Version Code
V1.00	A

Product Ordering Information

Part Number	Production Code	“Pb-free” Package Type	Weight (g)
MBI6650PSD	A	TO-252-5L	0.3142g
	B		

[查询"MBI6650PSD"供应商](#)

Disclaimer

Macroblock reserves the right to make changes, corrections, modifications, and improvements to their products and documents or discontinue any product or service without notice. Customers are advised to consult their sales representative for the latest product information before ordering. All products are sold subject to the terms and conditions supplied at the time of order acknowledgement, including those pertaining to warranty, patent infringement, and limitation of liability.

Macroblock's products are not designed to be used as components in device intended to support or sustain life or in military applications. Use of Macroblock's products in components intended for surgical implant into the body, or other applications in which failure of Macroblock's products could create a situation where personal death or injury may occur, is not authorized without the express written approval of the Managing Director of Macroblock.

Macroblock will not be held liable for any damages or claims resulting from the use of its products in medical and military applications.

All text, images, logos and information contained on this document is the intellectual property of Macroblock.

Unauthorized reproduction, duplication, extraction, use or disclosure of the above mentioned intellectual property will be deemed as infringement.