



LISY300AL

MEMS inertial sensor:
single-axis $\pm 300^\circ/\text{s}$ analog output yaw rate gyroscope

Features

- 2.7 V to 3.6 V single supply operation
- Low power consumption
- Embedded power-down
- $\pm 300^\circ/\text{s}$ full scale
- Absolute analog rate output
- Integrated low-pass filters
- Embedded self-test
- High shock survivability
- ECOPACK[®] RoHS and “Green” compliant (see [Section 4](#))

Description

The LISY300AL is a low-power single-axis yaw rate sensor. It includes a sensing element and an IC interface able to provide the measured angular rate to the external world through an analog output voltage.

The sensing element, capable of detecting the yaw rate, is manufactured using a dedicated micromachining process developed by ST to produce inertial sensors and actuators on silicon wafers.

The IC interface is manufactured using a CMOS process that allows a high level of integration to design a dedicated circuit which is trimmed to better match the sensing element characteristics.

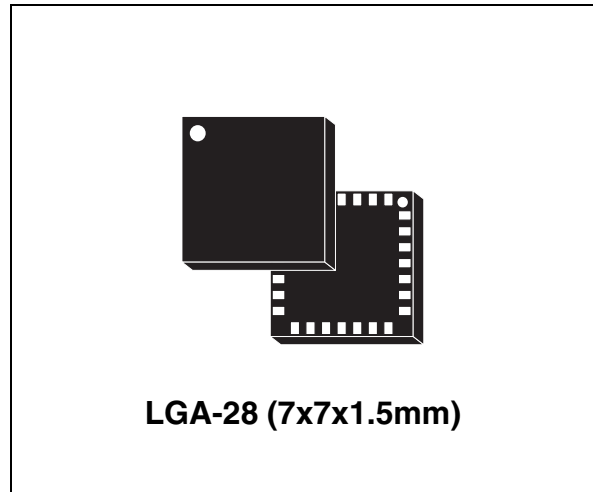

The LISY300AL has a full scale of $\pm 300^\circ/\text{s}$ and is capable of measuring rates with a -3 dB bandwidth up to 88 Hz.

The LISY300AL is available in a plastic land grid array (LGA) package and can operate within a temperature range from -40°C to $+85^\circ\text{C}$.

The LISY300AL belongs to a family of products suitable for a variety of applications, including:

- Gaming and virtual reality input devices
- Motion control with MMI (man-machine interface)
- Image stabilization for digital video and digital still cameras
- GPS navigation systems
- Appliances and robotics

Table 1. Device summary

Order code	Temperature range (°C)	Package	Packing
LISY300AL	-40 to +85	LGA-28 (7x7x1.5)	Tray
LISY300ALTR	-40 to +85	LGA-28 (7x7x1.5)	Tape and reel

Contents

1	Block diagram and pin description	3
1.1	Pin description	3
2	Mechanical and electrical specifications	5
2.1	Mechanical characteristics	5
2.2	Electrical characteristics	6
2.3	Absolute maximum ratings	7
2.4	Terminology	8
2.4.1	Sensitivity	8
2.4.2	Zero-rate level	8
2.4.3	Self-test	8
3	Application hints	9
3.1	Soldering information	10
4	Package information	11
5	Revision history	12

1 Block diagram and pin description

Figure 1. Block diagram

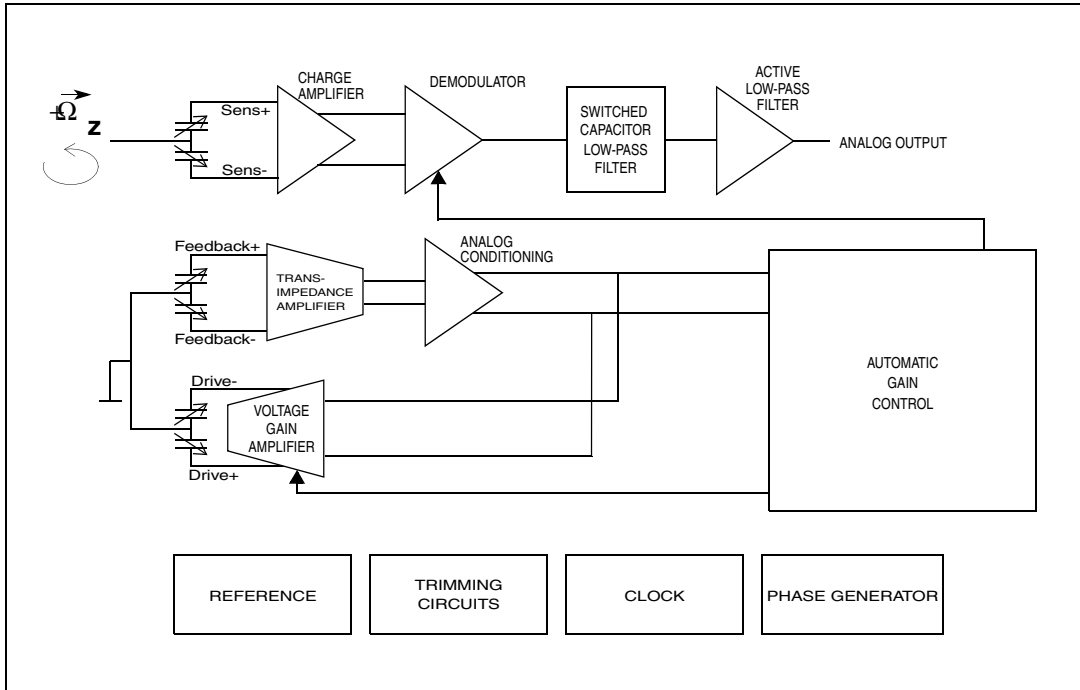

The vibration of the structure is maintained by a drive circuitry in a feedback loop. The sensing signal is filtered and appears as an analog signal at the output.

1.1 Pin description

Figure 2. Pin connection

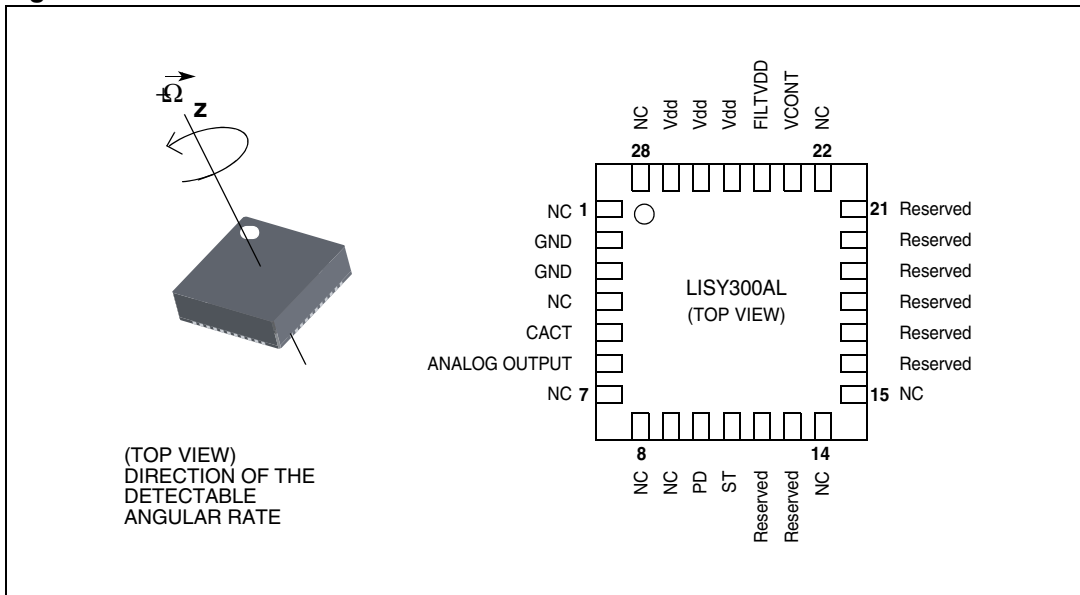

Table 2. Pin description

Pin #	Pin Name	Function
1	NC	Internally not connected
2	GND	0V supply
3	GND	0V supply
4	NC	Internally not connected
5	CACT	Active filter capacitor
6	ANALOG OUTPUT	Rate signal output voltage
7-9	NC	Internally not connected
10	PD	Power-down (logic 0: normal mode; logic 1: power-down mode)
11	ST	Self-test (logic 0: normal mode; logic 1: self-test)
12-13	Reserved	Leave unconnected
14-15	NC	Internally not connected
16-21	Reserved	Leave unconnected
22	NC	Internally not connected
23	VCONT	PLL filter connection pad #1
24	FILTVDD	PLL filter connection pad #2
25	Vdd	Power supply
26	Vdd	Power supply
27	Vdd	Power supply
28	NC	Internally not connected

2 Mechanical and electrical specifications

2.1 Mechanical characteristics

Table 3. Mechanical characteristics @ Vdd = 3.3 V, T = 25 °C unless otherwise noted⁽¹⁾

Symbol	Parameter	Test condition	Min.	Typ. ⁽²⁾	Max.	Unit
FS	Measurement range			±300		°/s
So	Sensitivity			3.3		mV/°/s
SoDr	Sensitivity change vs. temperature	From -40 °C to +85 °C		4		%
Voff	Zero-rate level ⁽³⁾			1.65		V
OffDr	Zero-rate level change vs. temperature	From -40 °C to +85 °C		5		°/s
NL	Non linearity ⁽⁴⁾	Best fit straight line		±0.8		% FS
BW	-3dB bandwidth ⁽³⁾⁽⁵⁾	C _{ACT} = 10 nF		88		Hz
Rn	Rate noise density			0.1		°/s / √Hz
Vt	Self-test output voltage change ⁽⁶⁾			+300		mV
Sup	Start-up time	Settling to ±5 °/s		300		ms
Fres	Sensing element resonant frequency			4.5		kHz
Top	Operating temperature range		-40		+85	°C
Wh	Product weight			160		mg

1. The product is factory calibrated at 3.3 V. The operational power supply range is specified in [Table 4](#).
2. Typical specifications are not guaranteed
3. The product is capable of sensing angular rates extending from DC to the selected bandwidth
4. Guaranteed by design
5. User selectable by external capacitor C_{ACT}
6. "Self-test output voltage change" is defined as V_{out}(V_{st} = logic 1) - V_{out}(V_{st} = logic 0)

2.2 Electrical characteristics

Table 4. Electrical characteristics @ Vdd =3.3 V, T=25 °C unless otherwise noted⁽¹⁾

Symbol	Parameter	Test condition	Min.	Typ. ⁽²⁾	Max.	Unit
Vdd	Supply voltage		2.7	3.3	3.6	V
Idd	Supply current	PD pin connected to GND		4.8		mA
IddPdn	Supply current in power-down mode	PD pin connected to Vdd		1		μA
VST	Self-test input	Logic 0 level	0		0.2*Vdd	V
		Logic 1 level	0.8*Vdd		Vdd	
VPD	Power-down input	Logic 0 level	0		0.2*Vdd	V
		Logic 1 level	0.8*Vdd		Vdd	
C _{ACT}	Active low-pass filter capacitor		10			nF
OVS	Output voltage swing ⁽³⁾	I _{out} = ±100μA	0.4		V _{dd} -0.4	V
C _{LOAD}	Capacitive load drive ⁽³⁾		0.4		10	nF
Top	Operating temperature range		-40		+85	°C

1. The product is factory calibrated at 3.3 V
2. Typical specifications are not guaranteed
3. Referred to ANALOG OUTPUT pin #6

2.3 Absolute maximum ratings

Stresses above those listed as "Absolute maximum ratings" may cause permanent damage to the device. This is a stress rating only and functional operation of the device under these conditions is not implied. Exposure to maximum rating conditions for extended periods may affect device reliability.

Table 5. Absolute maximum ratings

Symbol	Ratings	Maximum value	Unit
Vdd	Supply voltage	-0.3 to 6	V
Vin	Input voltage on any control pin (PD, ST)	-0.3 to Vdd +0.3	V
A _{UNP}	Acceleration (not powered)	3000 g for 0.5 ms	
		10000 g for 0.1 ms	
T _{STG}	Storage temperature range	-40 to +125	°C
ESD	Electrostatic discharge protection	2 (HBM)	kV

 This is a mechanical shock sensitive device, improper handling can cause permanent damage to the part

 This is an ESD sensitive device, improper handling can cause permanent damage to the part

2.4 Terminology

2.4.1 Sensitivity

A yaw rate gyroscope is a Z-axis rate device that produces a positive-going output voltage for counterclockwise rotation around the axis normal to the package top. Sensitivity describes the gain of the sensor and can be determined by applying a defined angular velocity to it. This value changes very little over temperature and also very little over time.

2.4.2 Zero-rate level

Zero-rate level describes the actual output signal if there is no angular rate present. For a 3.3 V powered sensor the absolute zero-rate output is ideally 1.65 V. Zero-rate level of precise MEMS sensors is, to some extent, a result of stress to the sensor and therefore zero-rate level can slightly change after mounting the sensor onto a printed circuit board or after exposing it to extensive mechanical stress. This value changes very little over temperature and also very little over time.

2.4.3 Self-test

Self-test allows to test the mechanical and electric part of the sensor, allowing the seismic mass to be moved by means of an electrostatic test-force. The Self-test function is off when the ST pin is connected to GND. When the ST pin is tied to Vdd, an actuation force is applied to the sensor, emulating a definite Coriolis force. In this case the sensor output will exhibit a voltage change in its DC level which is also depending on the supply voltage. When ST is active, the device output level is given by the algebraic sum of the signals produced by the velocity acting on the sensor and by the electrostatic test-force. If the output signals change within the amplitude specified in [Table 3](#), then the mechanical element is working properly and the parameters of the interface chip are within the defined specification.

3 Application hints

Figure 3. LISY300AL electrical connections and external components values

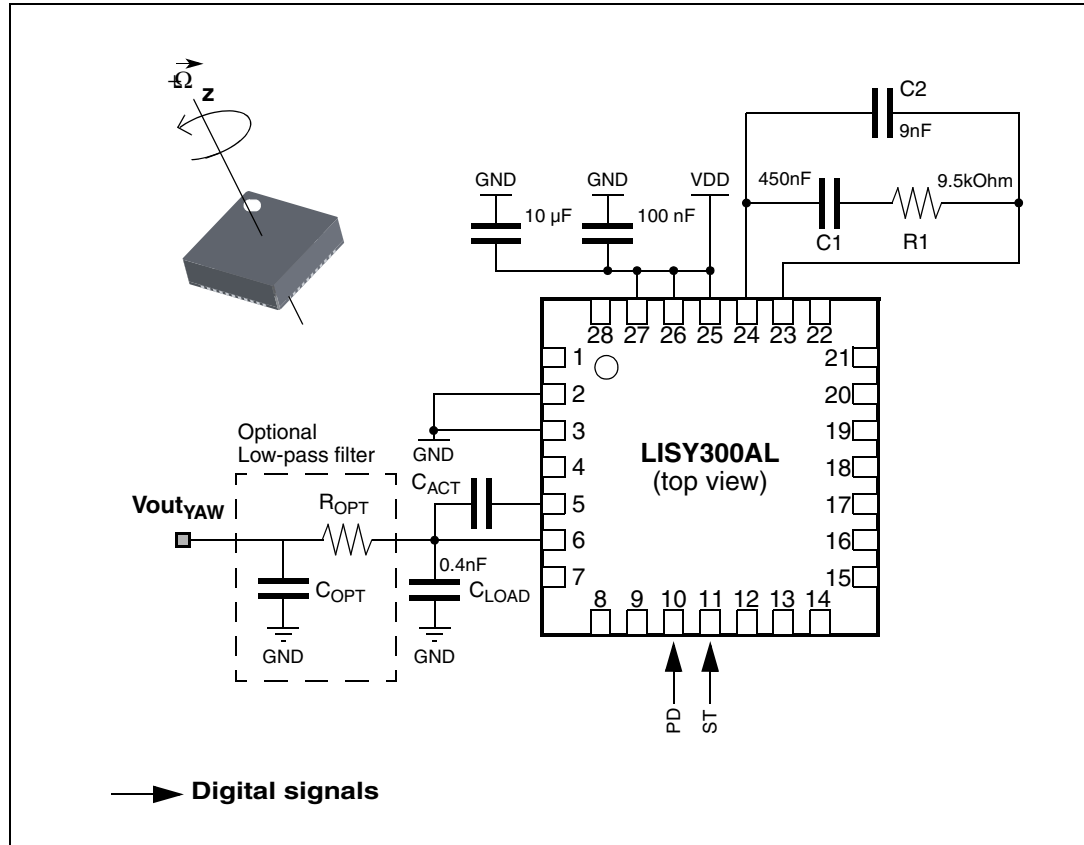

Power supply decoupling capacitors (100 nF ceramic or polyester + 10 µF Aluminum) should be placed as near as possible to the device (common design practice).

The LISY300AL allows to band limit the output rate response through the use of two first-order on-chip filters: a switched capacitor low-pass filter, with 400Hz -3dB bandwidth, in combination with an active low-pass filter. The active filter -3 dB nominal frequency (f_{tA}) is set through an internal resistor R_{ACT} and the external capacitor C_{ACT} (added between **CACT** pin #5 and **ANALOG OUTPUT** pin #6), by the formula:

$$f_{tA} = \frac{1}{2\pi \cdot R_{ACT} \cdot C_{ACT}}$$

The value of the internal resistor R_{ACT} is 180 kΩ while the external capacitor C_{ACT} is used to select the signal bandwidth. The sensed frequency range spans from DC up to the selected bandwidth.

In order to further reduce high-frequency noise, the LISY300AL supports an additional optional low-pass filter on **ANALOG OUTPUT** pin #6 (Figure 3). The cutoff frequency (f_{tP}) is given by the formula:

$$f_{tP} = \frac{1}{2\pi \cdot R_{OPT} \cdot C_{OPT}}$$

The LISY300AL IC includes a PLL (phase locked loop) circuit to synchronize driving and sensing interfaces. Capacitors and resistors must be added at the **FILTVDD** and **VCONT** pads (as shown in [Figure 3](#)) to implement a second-order low-pass filter. [Table 6](#) summarizes the PLL low-pass filter components' values.

Table 6. PLL low-pass filter components' values

Component	Value
C1	450 nF ± 10%
C2	9 nF ± 10%
R1	9.5 kΩ ± 10%

3.1 Soldering information

The LGA package is compliant with the ECOPACK[®], RoHS and “Green” standard. It is qualified for soldering heat resistance according to JEDEC J-STD-020C.

Leave “Pin 1 Indicator” unconnected during soldering.

Land pattern and soldering recommendations are available at www.st.com/mems.

4 Package information

In order to meet environmental requirements, ST offers these devices in ECOPACK® packages. These packages have a lead-free second level interconnect. The category of second level interconnect is marked on the inner box label, in compliance with JEDEC Standard JESD97. The maximum ratings related to soldering conditions are also marked on the inner box label. ECOPACK® is an ST trademark.

ECOPACK® specifications are available at: www.st.com.

Figure 4. LGA-28: mechanical data and package dimensions

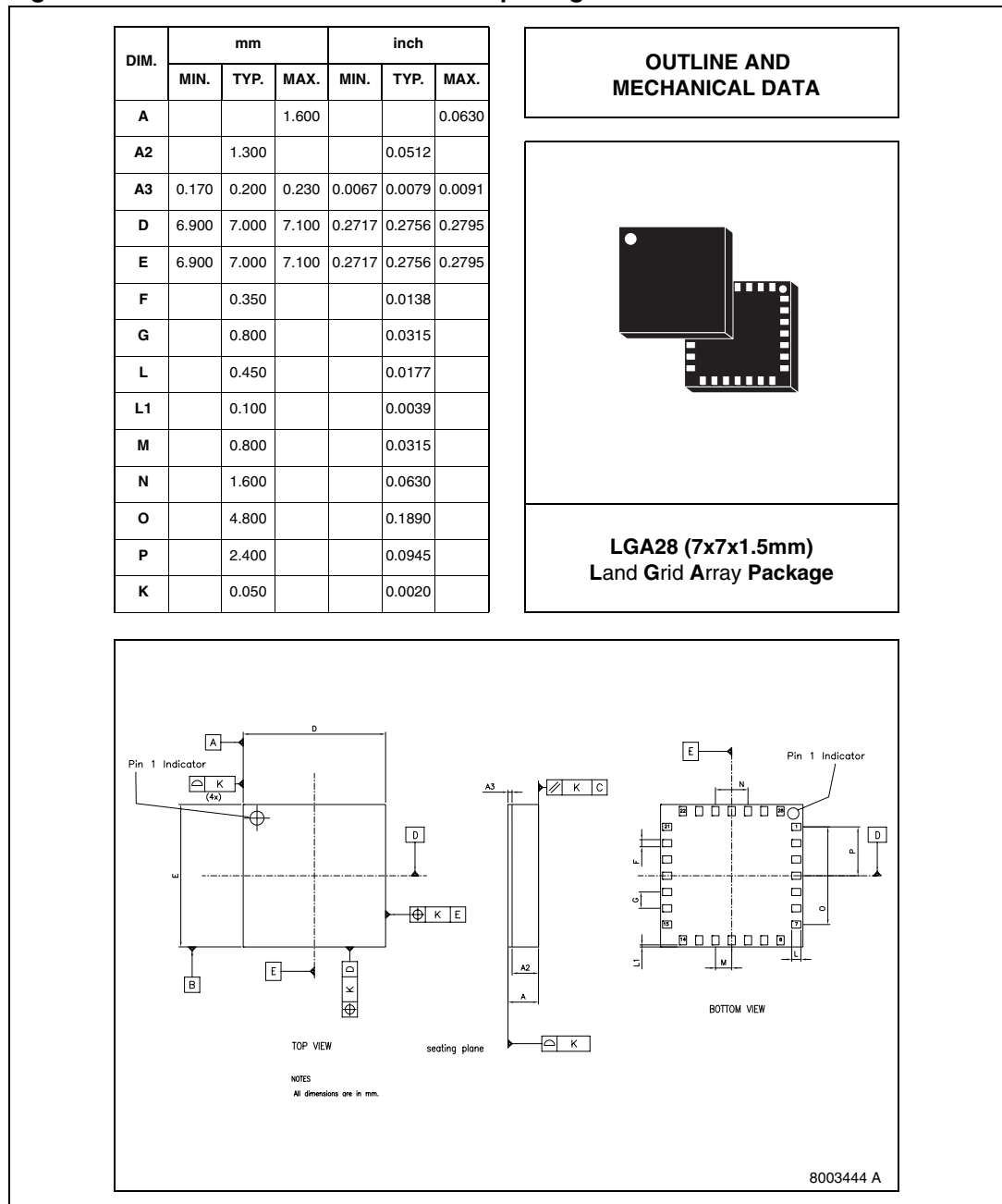

5 Revision history

Table 7. Document revision history

Date	Revision	Changes
29-May-08	1	Initial release

Please Read Carefully:

Information in this document is provided solely in connection with ST products. STMicroelectronics NV and its subsidiaries ("ST") reserve the right to make changes, corrections, modifications or improvements, to this document, and the products and services described herein at any time, without notice.

All ST products are sold pursuant to ST's terms and conditions of sale.

Purchasers are solely responsible for the choice, selection and use of the ST products and services described herein, and ST assumes no liability whatsoever relating to the choice, selection or use of the ST products and services described herein.

No license, express or implied, by estoppel or otherwise, to any intellectual property rights is granted under this document. If any part of this document refers to any third party products or services it shall not be deemed a license grant by ST for the use of such third party products or services, or any intellectual property contained therein or considered as a warranty covering the use in any manner whatsoever of such third party products or services or any intellectual property contained therein.

UNLESS OTHERWISE SET FORTH IN ST'S TERMS AND CONDITIONS OF SALE ST DISCLAIMS ANY EXPRESS OR IMPLIED WARRANTY WITH RESPECT TO THE USE AND/OR SALE OF ST PRODUCTS INCLUDING WITHOUT LIMITATION IMPLIED WARRANTIES OF MERCHANTABILITY, FITNESS FOR A PARTICULAR PURPOSE (AND THEIR EQUIVALENTS UNDER THE LAWS OF ANY JURISDICTION), OR INFRINGEMENT OF ANY PATENT, COPYRIGHT OR OTHER INTELLECTUAL PROPERTY RIGHT.

UNLESS EXPRESSLY APPROVED IN WRITING BY AN AUTHORIZED ST REPRESENTATIVE, ST PRODUCTS ARE NOT RECOMMENDED, AUTHORIZED OR WARRANTED FOR USE IN MILITARY, AIR CRAFT, SPACE, LIFE SAVING, OR LIFE SUSTAINING APPLICATIONS, NOR IN PRODUCTS OR SYSTEMS WHERE FAILURE OR MALFUNCTION MAY RESULT IN PERSONAL INJURY, DEATH, OR SEVERE PROPERTY OR ENVIRONMENTAL DAMAGE. ST PRODUCTS WHICH ARE NOT SPECIFIED AS "AUTOMOTIVE GRADE" MAY ONLY BE USED IN AUTOMOTIVE APPLICATIONS AT USER'S OWN RISK.

Resale of ST products with provisions different from the statements and/or technical features set forth in this document shall immediately void any warranty granted by ST for the ST product or service described herein and shall not create or extend in any manner whatsoever, any liability of ST.

ST and the ST logo are trademarks or registered trademarks of ST in various countries.

Information in this document supersedes and replaces all information previously supplied.

The ST logo is a registered trademark of STMicroelectronics. All other names are the property of their respective owners.

© 2008 STMicroelectronics - All rights reserved

STMicroelectronics group of companies

Australia - Belgium - Brazil - Canada - China - Czech Republic - Finland - France - Germany - Hong Kong - India - Israel - Italy - Japan - Malaysia - Malta - Morocco - Singapore - Spain - Sweden - Switzerland - United Kingdom - United States of America

www.st.com

