

# 2SK3887-01

N-CHANNEL SILICON POWER MOSFET

Outline Drawings (mm) 200406

## FUJI POWER MOSFET Super FAP-G Series

### Features

- High speed switching
- Low on-resistance
- No secondary breakdown
- Low driving power
- Avalanche-proof

### Applications

- Switching regulators
- DC-DC converters
- UPS (Uninterruptible Power Supply)

### Maximum ratings and characteristic

- Absolute maximum ratings (T<sub>c</sub>=25°C unless otherwise specified)

Item	Symbol	Ratings	Unit	Remarks
Drain-source voltage	V <sub>DS</sub>	600	V	
	V <sub>DSX</sub>	600	V	V <sub>GS</sub> =-30V
Continuous Drain Current	I <sub>D</sub>	9	A	
Pulsed Drain Current	I <sub>D(puls)</sub>	±36	A	
Gate-Source Voltage	V <sub>GS</sub>	±30	V	
Maximum Avalanche current	I <sub>AS</sub>	9	A	Note *1
Non-Repetitive Maximum Avalanche Energy	E <sub>AS</sub>	462.3	mJ	Note *2
Repetitive Maximum Avalanche Energy	E <sub>AR</sub>	16.5	mJ	Note *3
Maximum Drain-Source dV/dt	dV <sub>DS</sub> /dt	20	kV/μs	V <sub>DS</sub> ≤600V
Peak Diode Recovery dV/dt	dV/dt	5	kV/μs	Note *4
Max. Power Dissipation	P <sub>D</sub>	165	W	T <sub>c</sub> =25°C
		2.02		T <sub>a</sub> =25°C
Operating and Storage Temperature range	T <sub>ch</sub>	+150	°C	
	T <sub>stg</sub>	-55 to +150	°C	

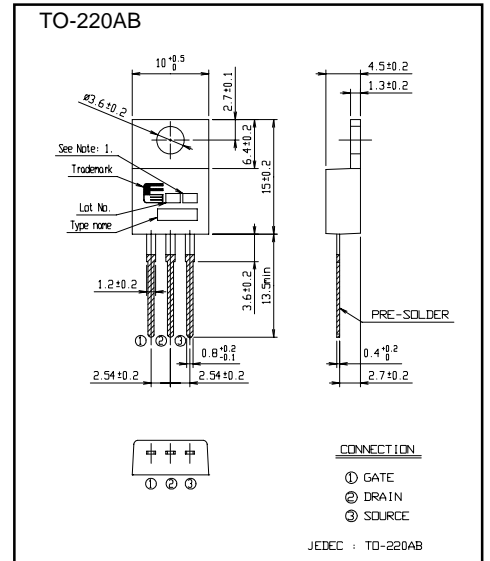

### Equivalent circuit schematic

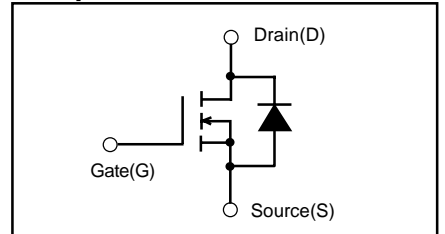

Note \*1: T<sub>ch</sub> ≤ 150°C, Repetitive and Non-repetitive

Note \*2: Starting T<sub>ch</sub>=25°C, I<sub>AS</sub>=3.6A, L=65.4mH,

V<sub>CC</sub>=60V, R<sub>G</sub>=50Ω

EAS limited by maximum channel temperature and avalanche current.

See to the 'Avalanche Energy' graph

Note \*3: Repetitive rating: Pulse width limited by maximum channel temperature.

See to the 'Transient Thermal impedance' graph

Note \*4: I<sub>F</sub> ≤ -I<sub>D</sub>, -di/dt=50A/μs, V<sub>CC</sub> ≤ BV<sub>DSS</sub>, T<sub>ch</sub> ≤ 150°C

### Electrical characteristics (T<sub>c</sub>=25°C unless otherwise specified)

Item	Symbol	Test Conditions	Min.	Typ.	Max.	Units
Drain-Source Breakdown Voltage	BV <sub>DSS</sub>	I <sub>D</sub> =250μA V <sub>GS</sub> =0V	600			V
Gate Threshold Voltage	V <sub>GS(th)</sub>	I <sub>D</sub> =250μA V <sub>DS</sub> =V <sub>GS</sub>	3.0		5.0	V
Zero Gate Voltage Drain Current	I <sub>DSS</sub>	V <sub>DS</sub> =600V V <sub>GS</sub> =0V			25	μA
		V <sub>DS</sub> =480V V <sub>GS</sub> =0V			250	
Gate-Source Leakage Current	I <sub>GSS</sub>	V <sub>GS</sub> =±30V V <sub>DS</sub> =0V			100	nA
Drain-Source On-State Resistance	R <sub>DS(on)</sub>	I <sub>D</sub> =4.5A V <sub>GS</sub> =10V		0.82	1.00	Ω
Forward Transconductance	g <sub>fs</sub>	I <sub>D</sub> =4.5A V <sub>DS</sub> =25V	4.5	9.0		S
Input Capacitance	C <sub>iss</sub>	V <sub>DS</sub> =25V		950	1425	pF
Output Capacitance	C <sub>oss</sub>	V <sub>GS</sub> =0V		130	195	
Reverse Transfer Capacitance	C <sub>rss</sub>	f=1MH		6.0	9.0	
Turn-On Time t <sub>on</sub>	td(on)	V <sub>CC</sub> =300V I <sub>D</sub> =4.5A		16	24	ns
	t <sub>r</sub>	V <sub>GS</sub> =10V		6.0	9.0	
Turn-Off Time t <sub>off</sub>	td(off)	R <sub>GS</sub> =10Ω		33	50	
	t <sub>f</sub>			5.5	8.3	
Total Gate Charge	Q <sub>G</sub>	V <sub>CC</sub> =300V		25	38	nC
Gate-Source Charge	Q <sub>GS</sub>	I <sub>D</sub> =9A		10	15	
Gate-Drain Charge	Q <sub>GD</sub>	V <sub>GS</sub> =10V		8.0	12	
Diode forward on-voltage	V <sub>SD</sub>	I <sub>F</sub> =9A V <sub>GS</sub> =0V T <sub>ch</sub> =25°C		1.10	1.50	V
Reverse recovery time	t <sub>rr</sub>	I <sub>F</sub> =9A V <sub>GS</sub> =0V		860		ns
Reverse recovery charge	Q <sub>rr</sub>	-di/dt=100A/μs T <sub>ch</sub> =25°C		7.0		μC

### Thermal characteristics

Item	Symbol	Test Conditions	Min.	Typ.	Max.	Units
Thermal resistance	R <sub>th(ch-c)</sub>	channel to case			0.758	°C/W
	R <sub>th(ch-a)</sub>	channel to ambient			62	°C/W

[查询"2SK3887-01"供应商](#)

## Characteristics

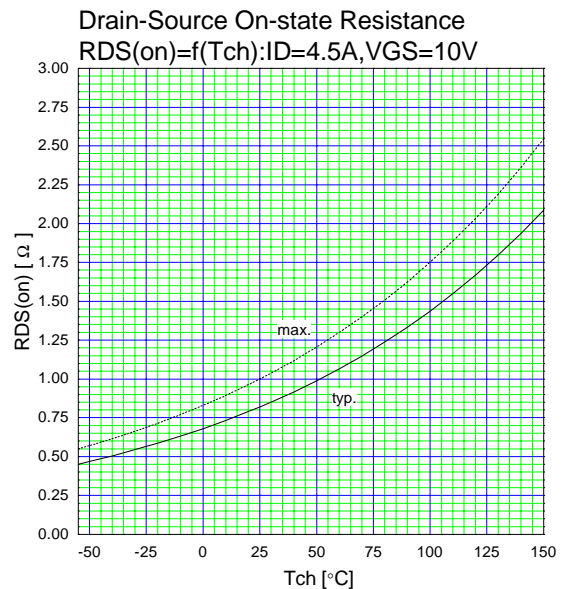
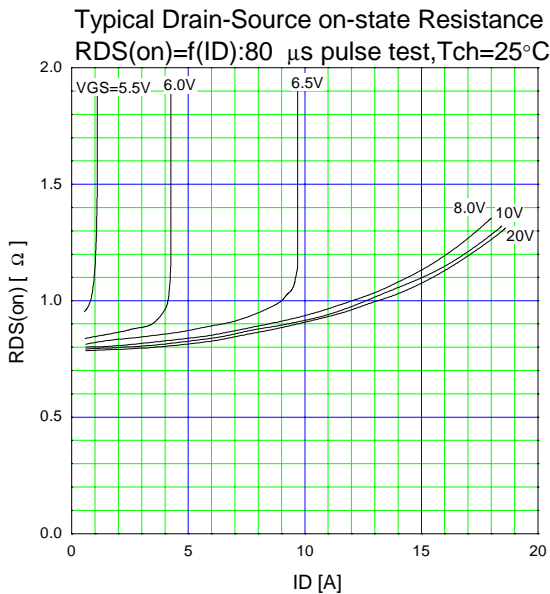
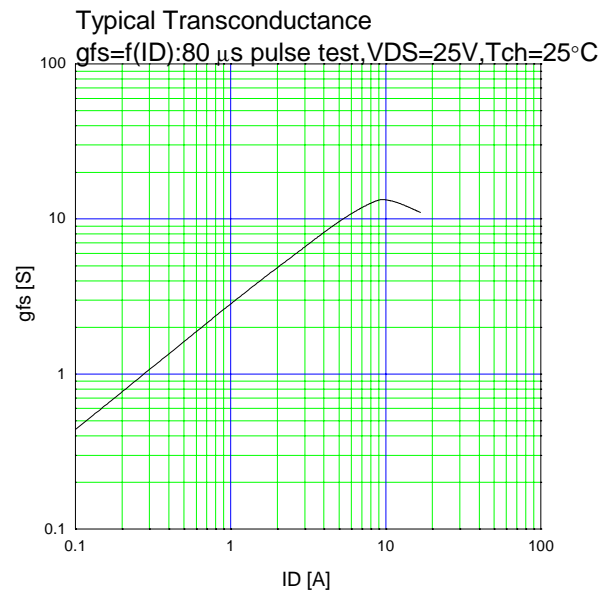
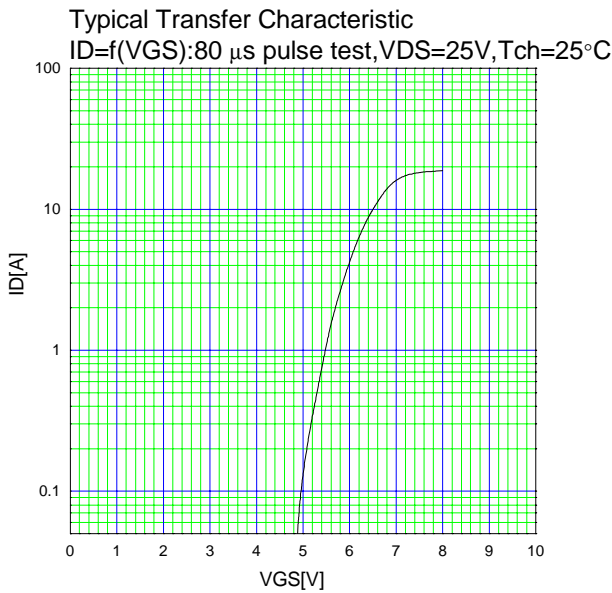
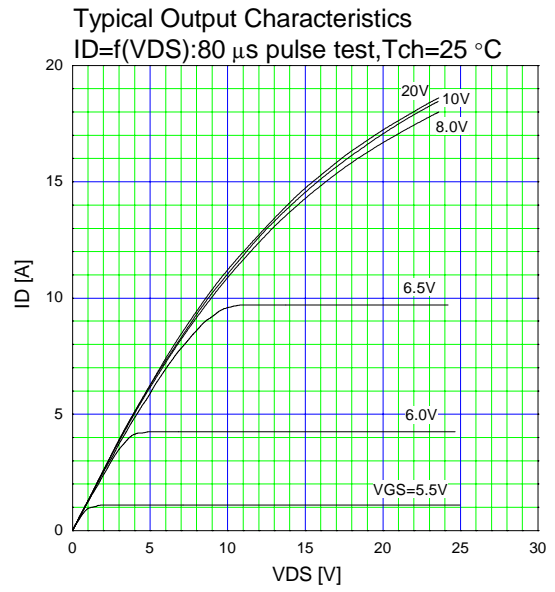
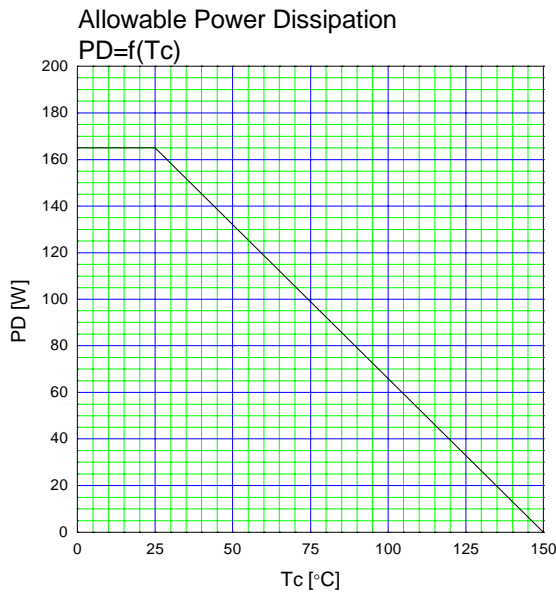

[查询"2SK3887-01"供应商](#)

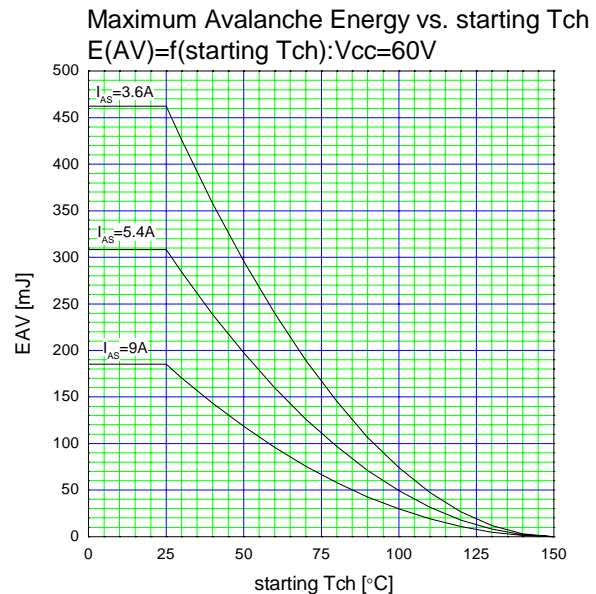
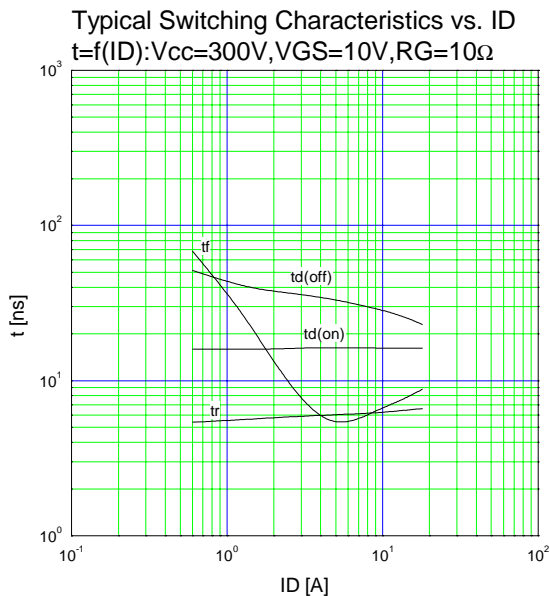
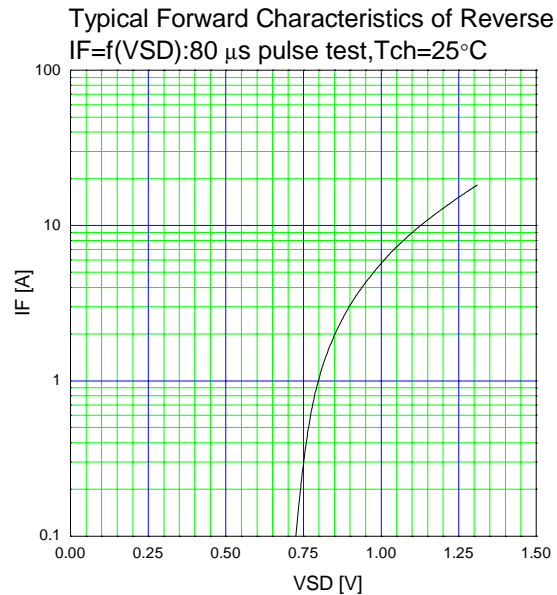
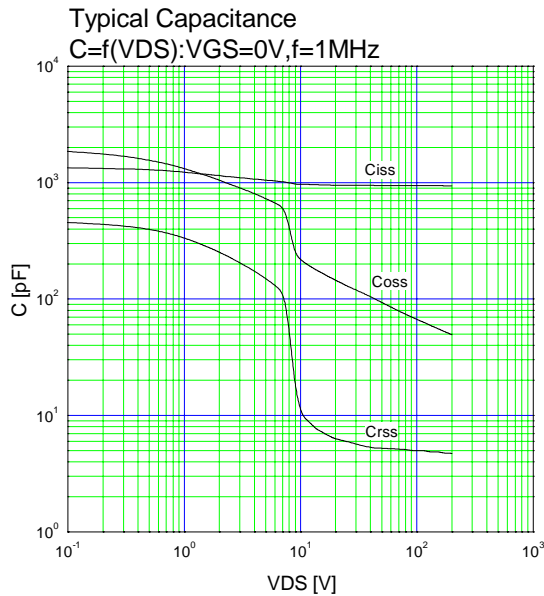
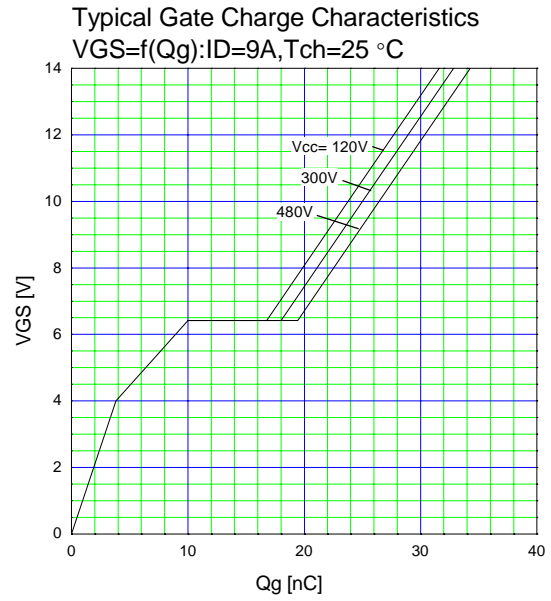
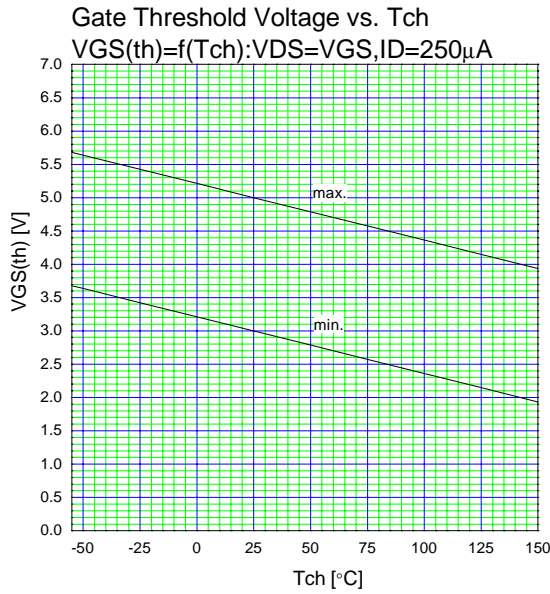

[查询"2SK3887-01"供应商](#)

