

JFET VHF/UHF Amplifier Transistor

N-Channel

Features

- Pb-Free Package is Available

MAXIMUM RATINGS

| Rating | Symbol | Value | Unit |
|----------------------|----------|-------|------|
| Drain-Source Voltage | V_{DS} | 30 | Vdc |
| Drain-Gate Voltage | V_{DG} | 30 | Vdc |
| Gate-Source Voltage | V_{GS} | 30 | Vdc |
| Gate Current | I_G | 10 | mAdc |

THERMAL CHARACTERISTICS

| Characteristic | Symbol | Max | Unit |
|--------------------------------------------------------------------------------------------------------------|-----------------|-------------|----------------------------|
| Total Device Dissipation FR-5 Board, (Note 1) $T_A = 25^\circ\text{C}$ Derate above 25°C | P_D | 225 1.8 | mW mW/ $^\circ\text{C}$ |
| Thermal Resistance, Junction-to-Ambient | $R_{\theta JA}$ | 556 | $^\circ\text{C}/\text{W}$ |
| Junction and Storage Temperature | T_J, T_{stg} | -55 to +150 | $^\circ\text{C}$ |

Maximum ratings are those values beyond which device damage can occur. Maximum ratings applied to the device are individual stress limit values (not normal operating conditions) and are not valid simultaneously. If these limits are exceeded, device functional operation is not implied, damage may occur and reliability may be affected.

1. FR-5 = 1.0 x 0.75 x 0.062 in.



ON Semiconductor[®]

<http://onsemi.com>

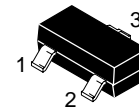
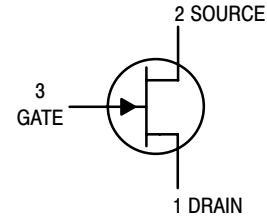

SOT-23 (TO-236)
CASE 318
STYLE 10

MARKING DIAGRAM

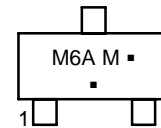

M6A = Device Code
M = Date Code*
▪ = Pb-Free Package

(Note: Microdot may be in either location)

*Date Code orientation and/or overbar may vary depending upon manufacturing location.

ORDERING INFORMATION

| Device | Package | Shipping [†] |
|--------------|---------------------|-----------------------|
| MMBF4416LT1 | SOT-23 | 3,000 / Tape & Reel |
| MMBF4416LT1G | SOT-23 (Pb-Free) | 3,000 / Tape & Reel |

[†]For information on tape and reel specifications, including part orientation and tape sizes, please refer to our Tape and Reel Packaging Specifications Brochure, BRD8011/D.

Preferred devices are recommended choices for future use and best overall value.

MMBF4416LT1

ELECTRICAL CHARACTERISTICS (T_A = 25°C unless otherwise noted)

| Characteristic | Symbol | Min | Max | Unit |
|-------------------------------------------------------------------------------------------------------------------------------------------------|----------------------|------|------------|-------|
| OFF CHARACTERISTICS | | | | |
| Gate-Source Breakdown Voltage (I _G = 1.0 μAdc, V _{DS} = 0) | V _{(BR)GSS} | 30 | - | Vdc |
| Gate Reverse Current (V _{GS} = 20 Vdc, V _{DS} = 0) (V _{GS} = 20 Vdc, V _{DS} = 0, T _A = 150°C) | I _{GSS} | - | 1.0 200 | nAdc |
| Gate Source Cutoff Voltage (I _D = 1.0 nAdc, V _{DS} = 15 Vdc) | V _{GS(off)} | - | -6.0 | Vdc |
| Gate Source Voltage (I _D = 0.5 mAdc, V _{DS} = 15 Vdc) | V _{GS} | -1.0 | -5.5 | Vdc |
| ON CHARACTERISTICS | | | | |
| Zero-Gate-Voltage Drain Current (V _{GS} = 15 Vdc, V _{GS} = 0) | I _{DSS} | 5.0 | 15 | mAdc |
| Gate-Source Forward Voltage (I _G = 1.0 mAdc, V _{DS} = 0) | V _{GS(f)} | - | 1.0 | Vdc |
| SMALL-SIGNAL CHARACTERISTICS | | | | |
| Forward Transfer Admittance (V _{DS} = 15 Vdc, V _{GS} = 0, f = 1.0 kHz) | Y _{fs} | 4500 | 7500 | μmhos |
| Output Admittance (V _{DS} = 15 Vdc, V _{GS} = 0, f = 1.0 kHz) | y _{os} | - | 50 | μmhos |
| Input Capacitance (V _{DS} = 15 Vdc, V _{GS} = 0, f = 1.0 MHz) | C _{iss} | - | 4.0 | pF |
| Reverse Transfer Capacitance (V _{DS} = 15 Vdc, V _{GS} = 0, f = 10 MHz) | C _{rss} | - | 0.8 | pF |
| Output Capacitance (V _{DS} = 15 Vdc, V _{GS} = 0, f = 1.0 MHz) | C _{oss} | - | 2.0 | pF |

COMMON SOURCE CHARACTERISTICS ADMITTANCE PARAMETERS

(V_{DS} = 15 Vdc, T_{channel} = 25°C)

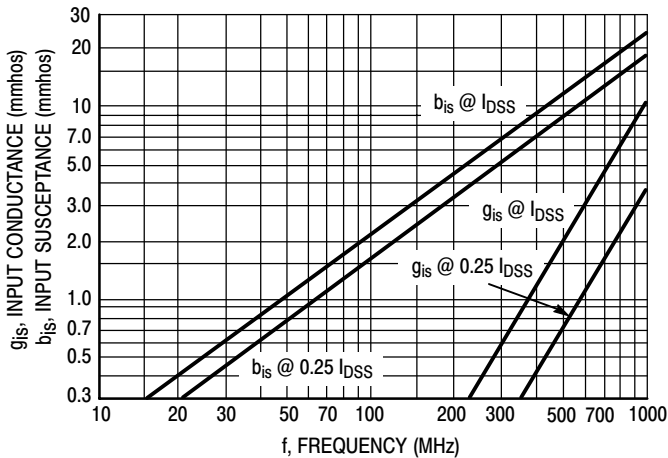

Figure 1. Input Admittance (y_{is})

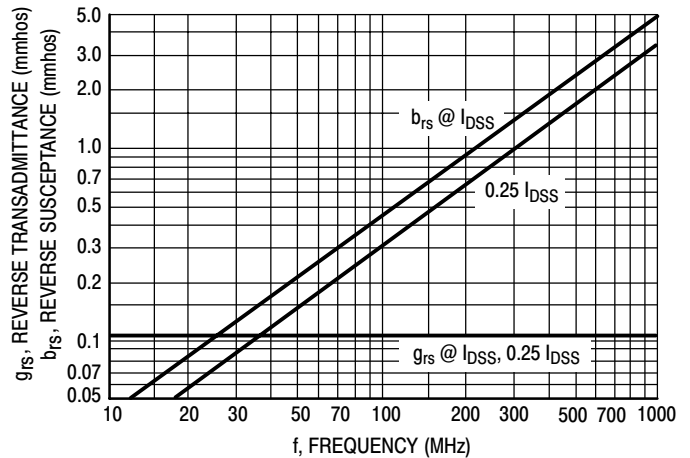

Figure 2. Reverse Transfer Admittance (y_{rs})

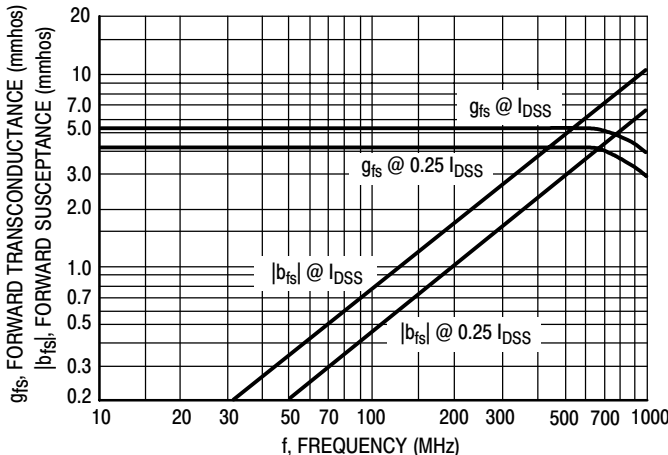

Figure 3. Forward Transadmittance (y_{fs})

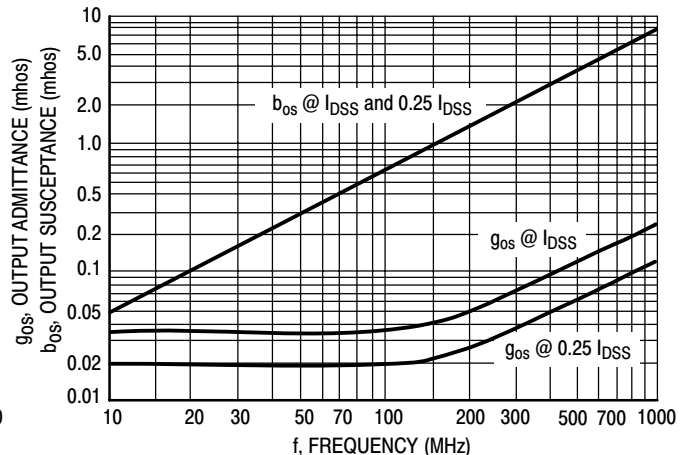

Figure 4. Output Admittance (y_{os})

MMBF4416LT1

查询"MMBF4416LT1G"供应商 **COMMON SOURCE CHARACTERISTICS**

S-PARAMETERS

($V_{DS} = 15 \text{ Vdc}$, $T_{\text{channel}} = 25^\circ\text{C}$, Data Points in MHz)

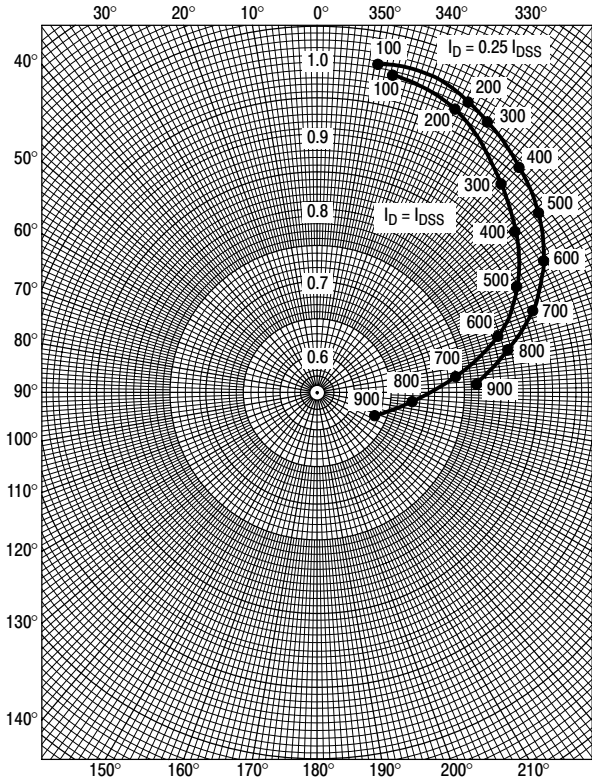

Figure 5. S_{11s}

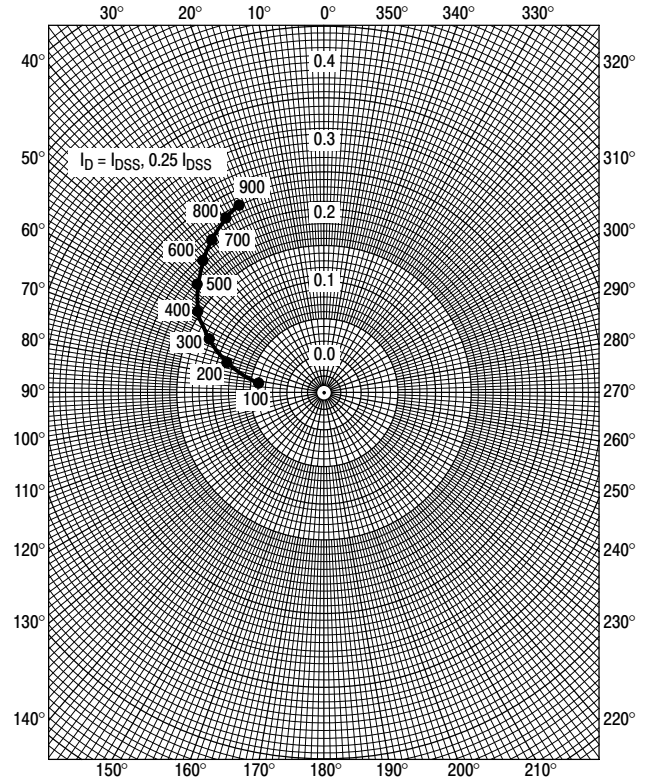

Figure 6. S_{12s}

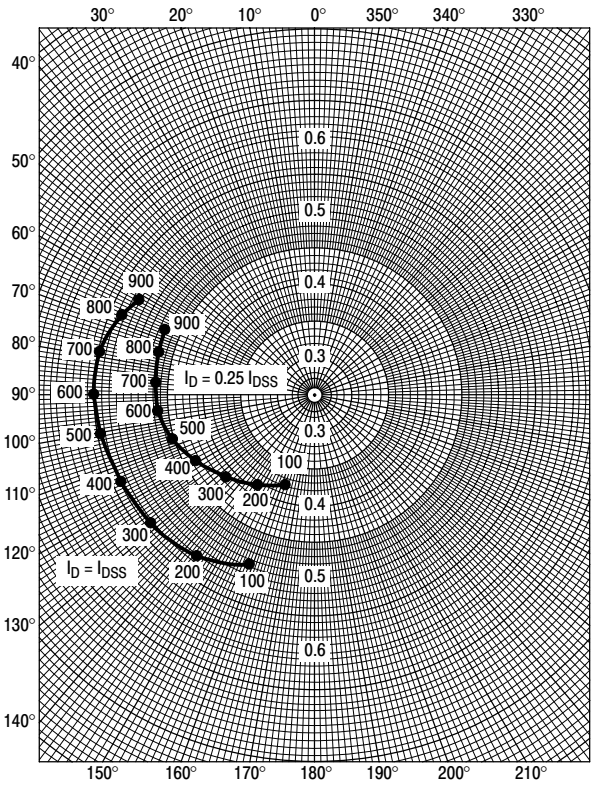

Figure 7. S_{21s}

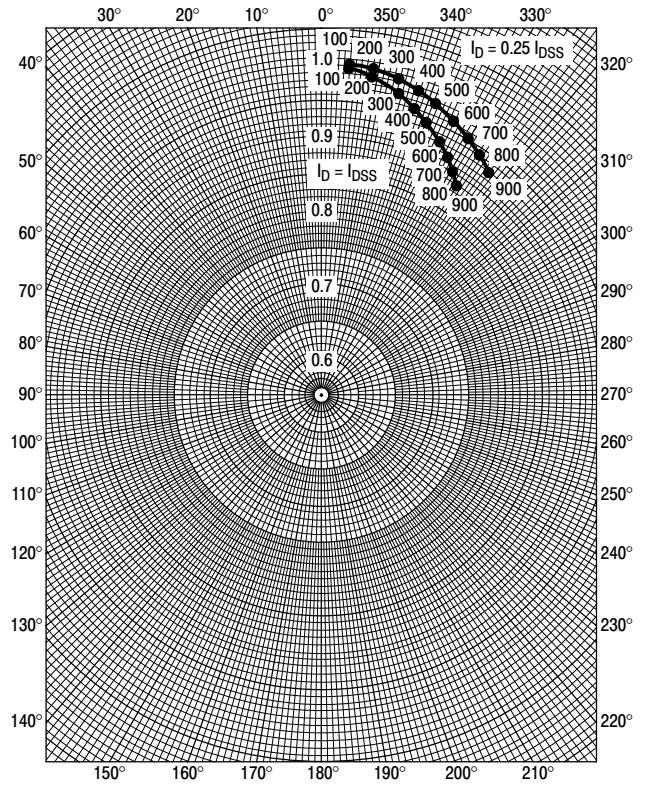

Figure 8. S_{22s}

MMBF4416LT1

COMMON GATE CHARACTERISTICS ADMITTANCE PARAMETERS

查询"MMBF4416LT1G"供应商

($V_{DG} = 15 \text{ Vdc}$, $T_{channel} = 25^\circ\text{C}$)

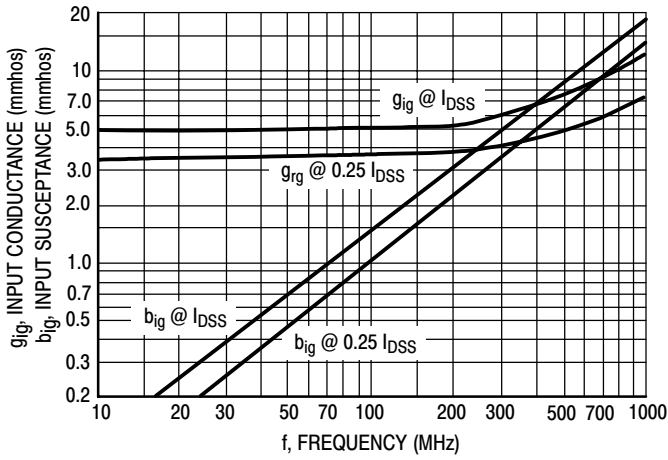

Figure 9. Input Admittance (y_{ig})

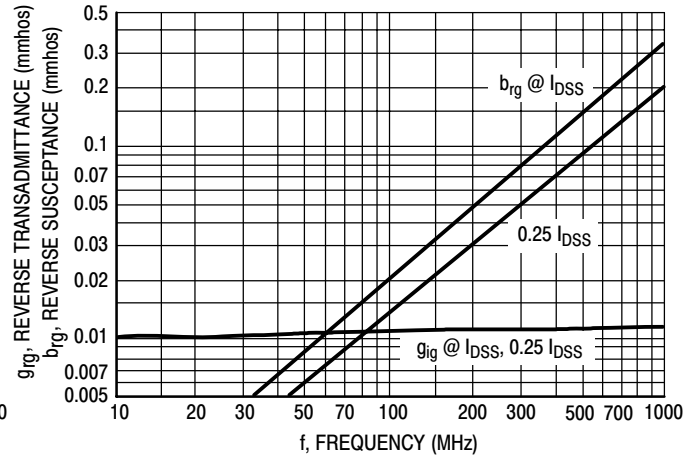

Figure 10. Reverse Transfer Admittance (y_{rg})

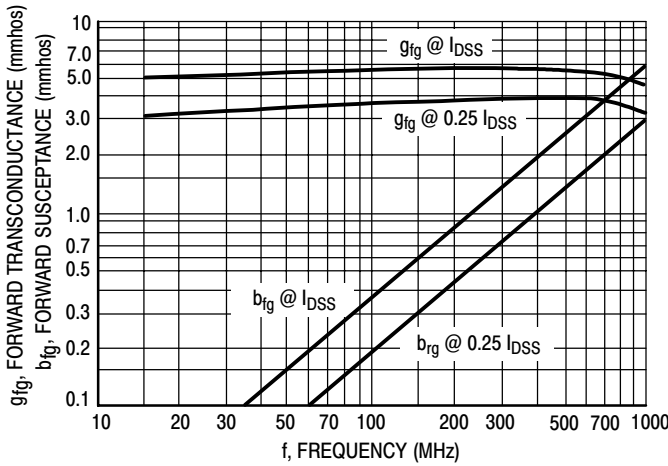

Figure 11. Forward Transfer Admittance (y_{fg})

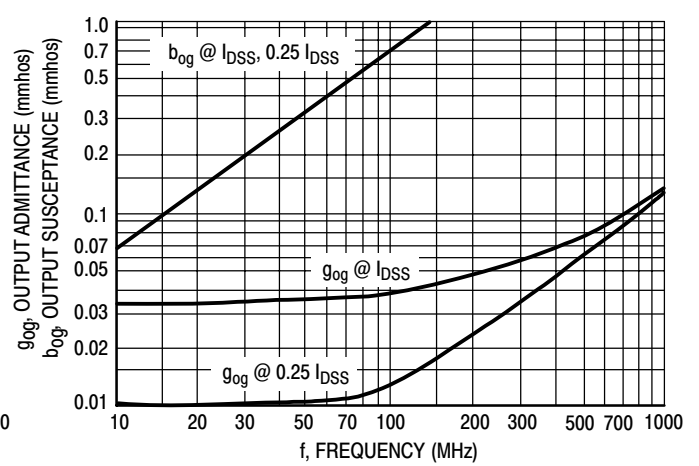

Figure 12. Output Admittance (y_{og})

[查询"MMBF4416LT1G"供应商](#)

COMMON GATE CHARACTERISTICS
S-PARAMETERS

($V_{DS} = 15$ Vdc, $T_{channel} = 25^{\circ}C$, Data Points in MHz)

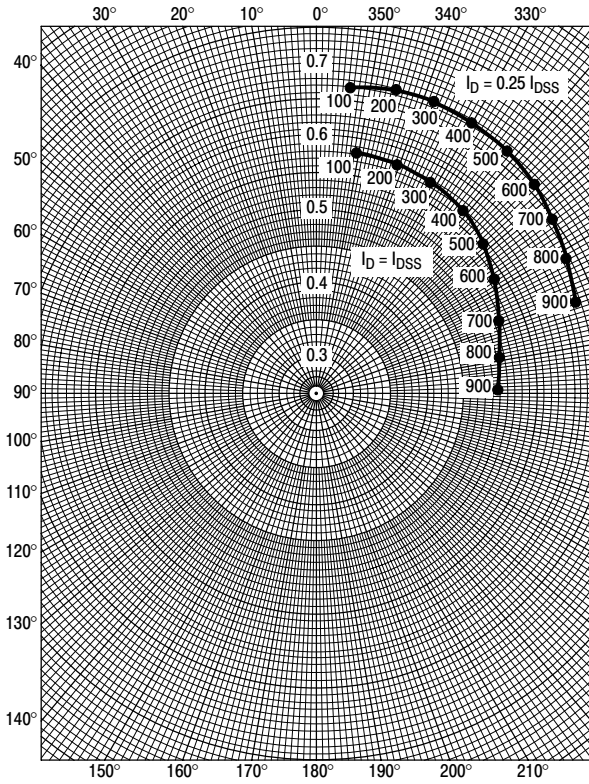

Figure 13. S_{11g}

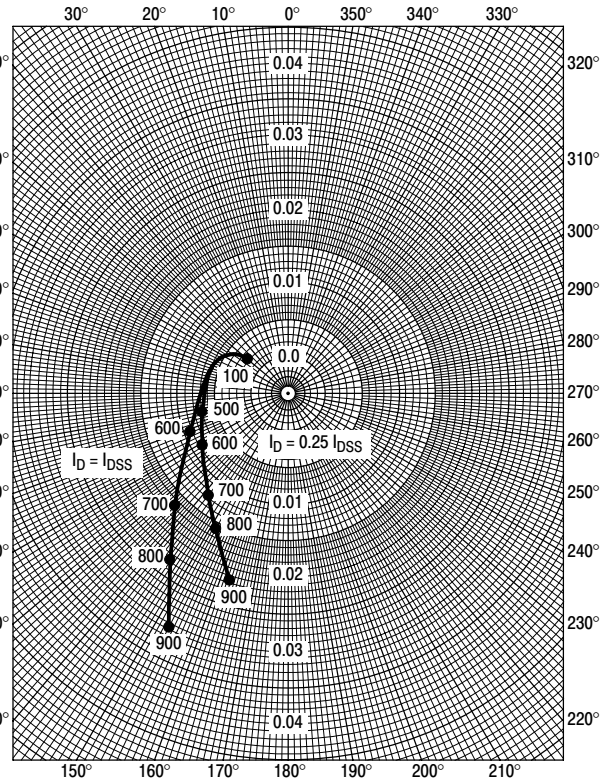

Figure 14. S_{12g}

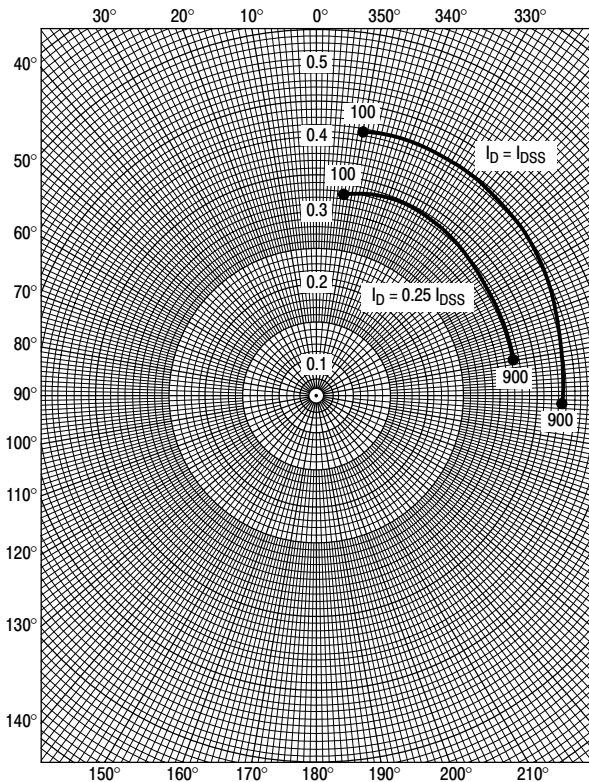

Figure 15. S_{21g}

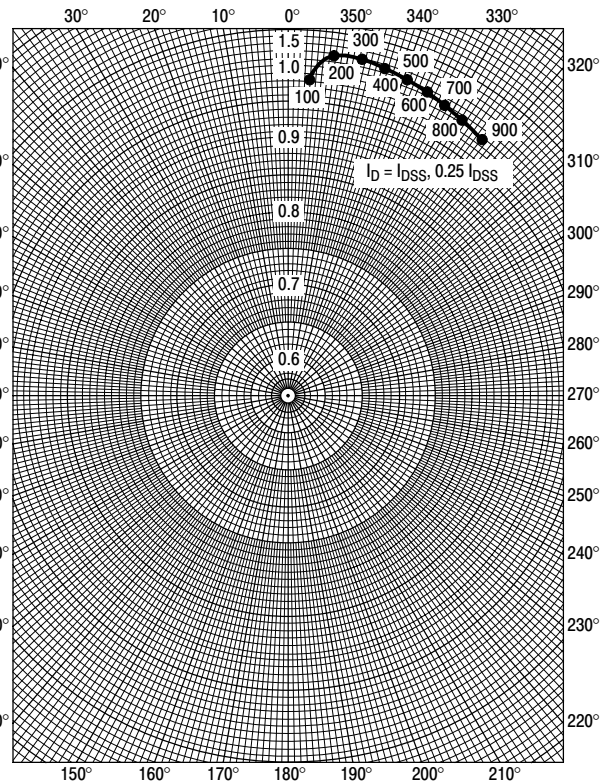

Figure 16. S_{22g}

MMBF4416LT1

查询"MMBF4416LT1G"供应商

PACKAGE DIMENSIONS

SOT-23 (TO-236)
CASE 318-08
ISSUE AN

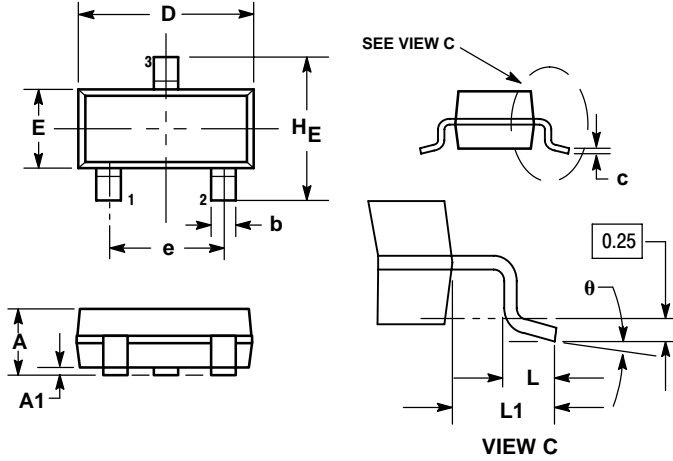

NOTES:

1. DIMENSIONING AND TOLERANCING PER ANSI Y14.5M, 1982.
2. CONTROLLING DIMENSION: INCH.
3. MAXIMUM LEAD THICKNESS INCLUDES LEAD FINISH THICKNESS. MINIMUM LEAD THICKNESS IS THE MINIMUM THICKNESS OF BASE MATERIAL.
4. 318-01 THRU -07 AND -09 OBSOLETE, NEW STANDARD 318-08.

| DIM | MILLIMETERS | | | INCHES | | |
|-----|-------------|------|------|--------|-------|-------|
| | MIN | NOM | MAX | MIN | NOM | MAX |
| A | 0.89 | 1.00 | 1.11 | 0.035 | 0.040 | 0.044 |
| A1 | 0.01 | 0.06 | 0.10 | 0.001 | 0.002 | 0.004 |
| b | 0.37 | 0.44 | 0.50 | 0.015 | 0.018 | 0.020 |
| c | 0.09 | 0.13 | 0.18 | 0.003 | 0.005 | 0.007 |
| D | 2.80 | 2.90 | 3.04 | 0.110 | 0.114 | 0.120 |
| E | 1.20 | 1.30 | 1.40 | 0.047 | 0.051 | 0.055 |
| e | 1.78 | 1.90 | 2.04 | 0.070 | 0.075 | 0.081 |
| L | 0.10 | 0.20 | 0.30 | 0.004 | 0.008 | 0.012 |
| L1 | 0.35 | 0.54 | 0.69 | 0.014 | 0.021 | 0.029 |
| HE | 2.10 | 2.40 | 2.64 | 0.083 | 0.094 | 0.104 |

STYLE 10:

1. DRAIN
2. SOURCE
3. GATE

SOLDERING FOOTPRINT*

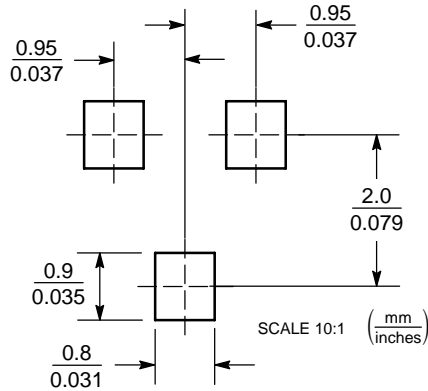

*For additional information on our Pb-Free strategy and soldering details, please download the ON Semiconductor Soldering and Mounting Techniques Reference Manual, SOLDERRM/D.

ON Semiconductor and are registered trademarks of Semiconductor Components Industries, LLC (SCILLC). SCILLC reserves the right to make changes without further notice to any products herein. SCILLC makes no warranty, representation or guarantee regarding the suitability of its products for any particular purpose, nor does SCILLC assume any liability arising out of the application or use of any product or circuit, and specifically disclaims any and all liability, including without limitation special, consequential or incidental damages. "Typical" parameters which may be provided in SCILLC data sheets and/or specifications can and do vary in different applications and actual performance may vary over time. All operating parameters, including "Typicals" must be validated for each customer application by customer's technical experts. SCILLC does not convey any license under its patent rights nor the rights of others. SCILLC products are not designed, intended, or authorized for use as components in systems intended for surgical implant into the body, or other applications intended to support or sustain life, or for any other application in which the failure of the SCILLC product could create a situation where personal injury or death may occur. Should Buyer purchase or use SCILLC products for any such unintended or unauthorized application, Buyer shall indemnify and hold SCILLC and its officers, employees, subsidiaries, affiliates, and distributors harmless against all claims, costs, damages, and expenses, and reasonable attorney fees arising out of, directly or indirectly, any claim of personal injury or death associated with such unintended or unauthorized use, even if such claim alleges that SCILLC was negligent regarding the design or manufacture of the part. SCILLC is an Equal Opportunity/Affirmative Action Employer. This literature is subject to all applicable copyright laws and is not for resale in any manner.

PUBLICATION ORDERING INFORMATION

LITERATURE FULFILLMENT:

Literature Distribution Center for ON Semiconductor
P.O. Box 61312, Phoenix, Arizona 85082-1312 USA
Phone: 480-829-7710 or 800-344-3860 Toll Free USA/Canada
Fax: 480-829-7709 or 800-344-3867 Toll Free USA/Canada
Email: orderlit@onsemi.com

N. American Technical Support: 800-282-9855 Toll Free
USA/Canada

Japan: ON Semiconductor, Japan Customer Focus Center
2-9-1 Kamimeguro, Meguro-ku, Tokyo, Japan 153-0051
Phone: 81-3-5773-3850

ON Semiconductor Website: <http://onsemi.com>

Order Literature: <http://www.onsemi.com/litorder>

For additional information, please contact your local Sales Representative.

MMBF4416LT1/D