

MOS FIELD EFFECT TRANSISTOR

2SK3325

SWITCHING

N-CHANNEL POWER MOS FET

INDUSTRIAL USE

DESCRIPTION

The 2SK3325 is N-Channel DMOS FET device that features a low gate charge and excellent switching characteristics, and designed for high voltage applications such as switching power supply, AC adapter.

FEATURES

- Low gate charge:
 $Q_G = 22 \text{ nC TYP. (} V_{DD} = 400 \text{ V, } V_{GS} = 10 \text{ V, } I_D = 10 \text{ A)}$
- Gate voltage rating: $\pm 30 \text{ V}$
- Low on-state resistance
 $R_{DS(on)} = 0.85 \Omega \text{ MAX. (} V_{GS} = 10 \text{ V, } I_D = 5.0 \text{ A)}$
- Avalanche capability ratings
- TO-220AB, TO-262, TO-263 package

ABSOLUTE MAXIMUM RATINGS ($T_A = 25^\circ\text{C}$)

Drain to Source Voltage ($V_{GS} = 0 \text{ V}$)	V_{DSS}	500	V
Gate to Source Voltage ($V_{DS} = 0 \text{ V}$)	$V_{GSS(AC)}$	± 30	V
Drain Current (DC)	$I_{D(DC)}$	± 10	A
Drain Current (pulse) ^{Note1}	$I_{D(pulse)}$	± 40	A
Total Power Dissipation ($T_c = 25^\circ\text{C}$)	P_T	85	W
Total Power Dissipation ($T_A = 25^\circ\text{C}$)	P_T	1.5	W
Channel Temperature	T_{ch}	150	$^\circ\text{C}$
Storage Temperature	T_{stg}	$-55 \text{ to } +150$	$^\circ\text{C}$
Single Avalanche Current ^{Note2}	I_{AS}	10	A
Single Avalanche Energy ^{Note2}	E_{AS}	10.7	mJ

Notes 1. $PW \leq 10 \mu\text{s}$, Duty Cycle $\leq 1 \%$

2. Starting $T_{ch} = 25^\circ\text{C}$, $V_{DD} = 150 \text{ V}$, $R_G = 25 \Omega$, $V_{GS} = 20 \text{ V} \rightarrow 0 \text{ V}$

ORDERING INFORMATION

PART NUMBER	PACKAGE
2SK3325	TO-220AB
2SK3325-S	TO-262
2SK3325-ZJ	TO-263

(TO-220AB)

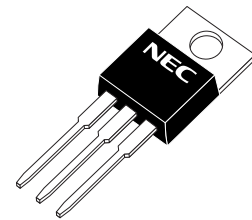

(TO-262)

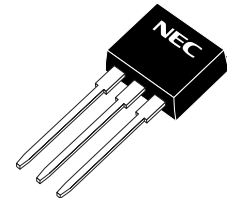

(TO-263)

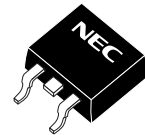

The information in this document is subject to change without notice. Before using this document, please confirm that this is the latest version.
 Not all devices/types available in every country. Please check with local NEC representative for availability and additional information.

查询"2SK3325-S"供应商

ELECTRICAL CHARACTERISTICS (T_A = 25 °C)

CHARACTERISTICS	SYMBOL	TEST CONDITIONS	MIN.	TYP.	MAX.	UNIT
Drain Leakage Current	I _{DSS}	V _{DS} = 500 V, V _{GS} = 0 V			100	μA
Gate to Source Leakage Current	I _{GSS}	V _{GS} = ±30 V, V _{DS} = 0 V			±100	nA
Gate to Source Cut-off Voltage	V _{GS(off)}	V _{DS} = 10 V, I _D = 1 mA	2.5		3.5	V
Forward Transfer Admittance	y _{fs}	V _{DS} = 10 V, I _D = 5.0 A	2.0	4.0		S
Drain to Source On-state Resistance	R _{DS(on)}	V _{GS} = 10 V, I _D = 5.0 A		0.68	0.85	Ω
Input Capacitance	C _{iss}	V _{DS} = 10 V, V _{GS} = 0 V, f = 1 MHz		1200		pF
Output Capacitance	C _{oss}			190		pF
Reverse Transfer Capacitance	C _{rss}			10		pF
Turn-on Delay Time	t _{d(on)}	V _{DD} = 150 V, I _D = 5.0 A, V _{GS(on)} = 10 V, R _G = 10 Ω, R _L = 60 Ω		21		ns
Rise Time	t _r			11		ns
Turn-off Delay Time	t _{d(off)}			40		ns
Fall Time	t _f			9.5		ns
Total Gate Charge	Q _G	V _{DD} = 400 V, V _{GS} = 10 V, I _D = 10 A		22		nC
Gate to Source Charge	Q _{GS}			6.5		nC
Gate to Drain Charge	Q _{GD}			7.5		nC
Body Diode Forward Voltage	V _{F(S-D)}	I _F = 10 A, V _{GS} = 0 V		1.0		V
Reverse Recovery Time	t _{rr}	I _F = 10 A, V _{GS} = 0 V, di/dt = 50 A/μs		0.5		μs
Reverse Recovery Charge	Q _{rr}			2.6		μC

TEST CIRCUIT 1 AVALANCHE CAPABILITY

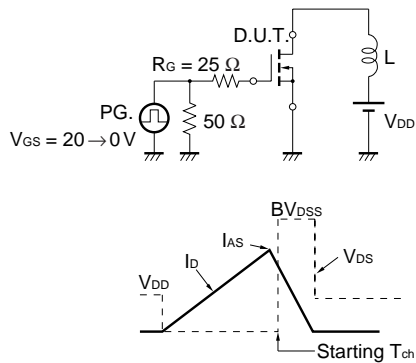

TEST CIRCUIT 2 SWITCHING TIME

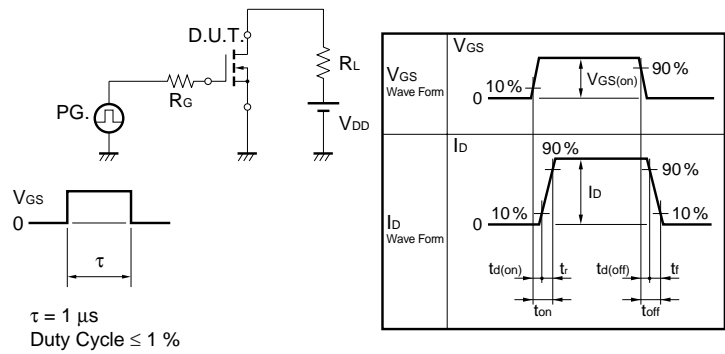

TEST CIRCUIT 3 GATE CHARGE

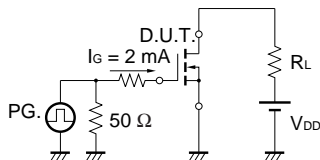

查询"2SK3325 S"供应商

TYPICAL CHARACTERISTICS (T_A = 25 °C)

Figure1. DERATING FACTOR OF FORWARD BIAS SAFE OPERATING AREA

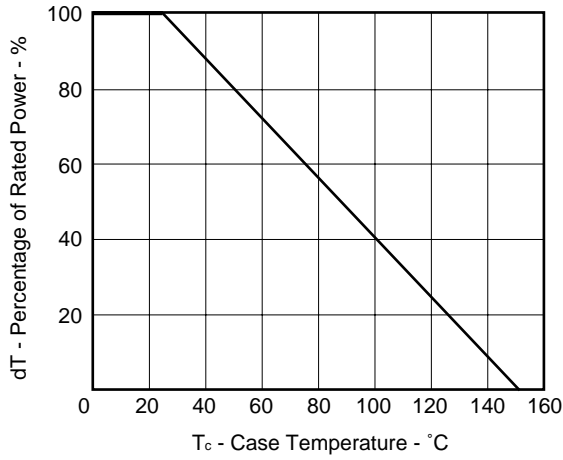

Figure2. TOTAL POWER DISSIPATION vs. CASE TEMPERATURE

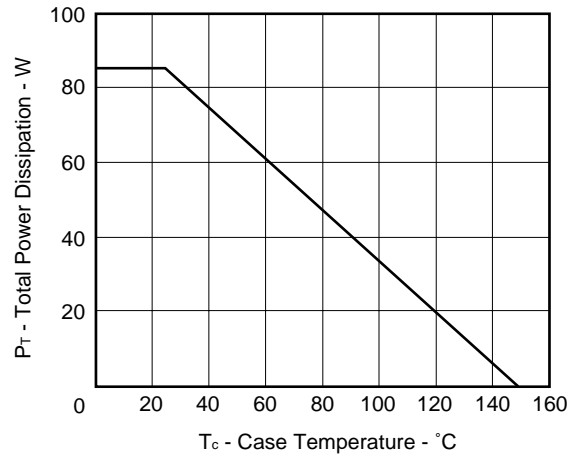

Figure3. FORWARD BIAS SAFE OPERATING AREA

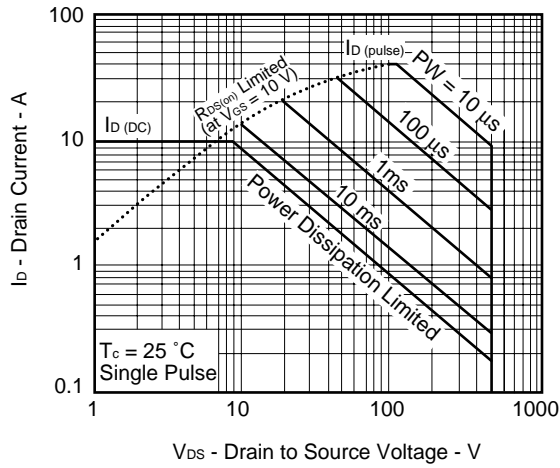

Figure4. DRAIN CURRENT vs. DRAIN TO SOURCE VOLTAGE

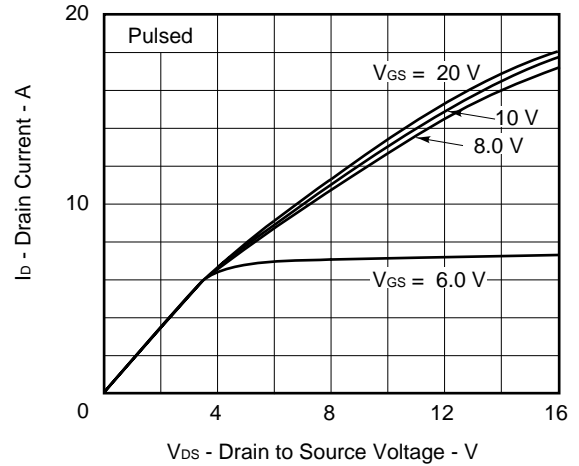
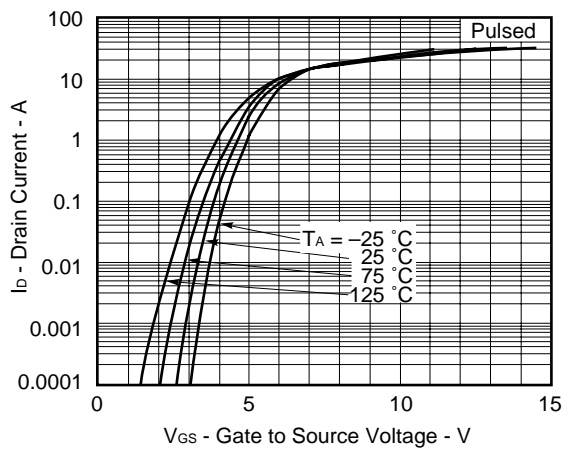

Figure5. DRAIN CURRENT vs. GATE TO SOURCE VOLTAGE



[查询"2SK3325-S"供应商](#)

Figure6. TRANSIENT THERMAL RESISTANCE vs. PULSE WIDTH

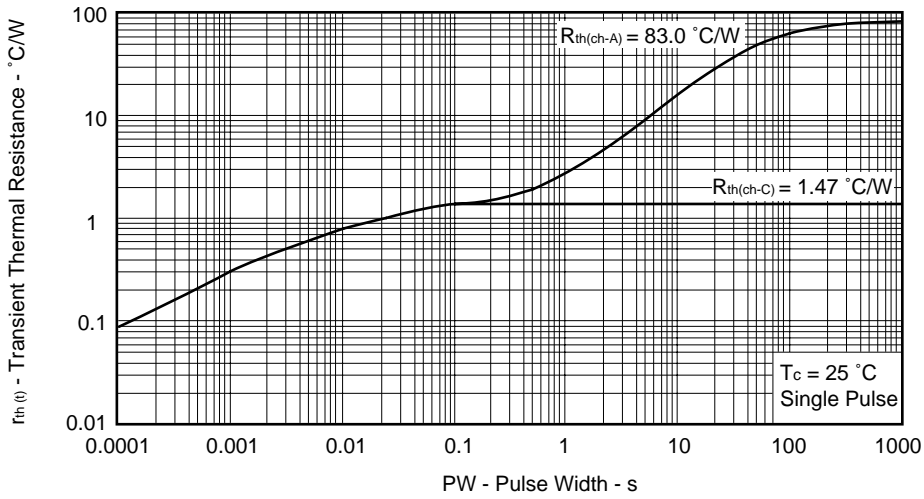

Figure7. FORWARD TRANSFER ADMITTANCE vs. DRAIN CURRENT

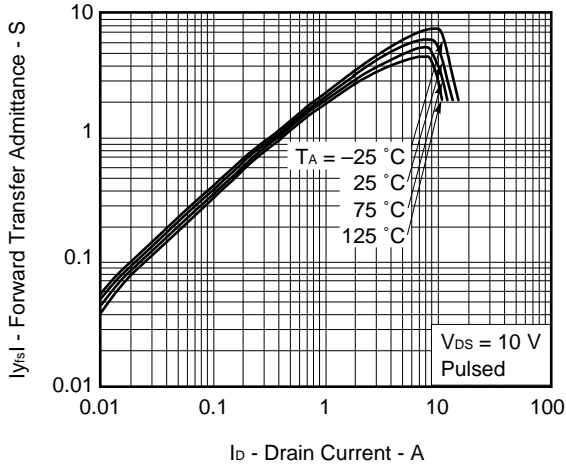

Figure8. DRAIN TO SOURCE ON-STATE RESISTANCE vs. GATE TO SOURCE VOLTAGE

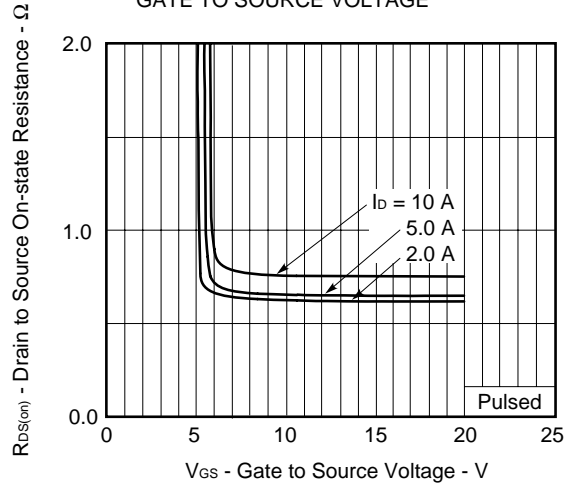

Figure9. DRAIN TO SOURCE ON-STATE RESISTANCE vs. DRAIN CURRENT

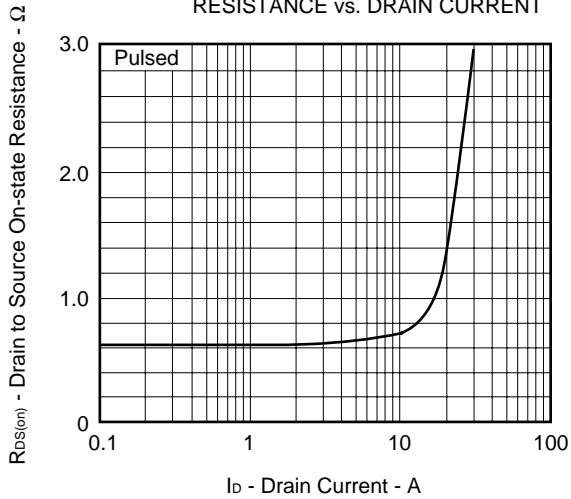
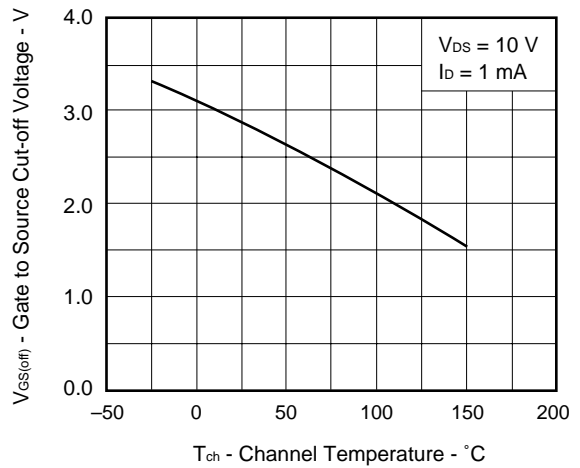

Figure10. GATE TO SOURCE CUT-OFF VOLTAGE vs. CHANNEL TEMPERATURE



查询"2SK3325-S"供应商

Figure11. DRAIN TO SOURCE ON-STATE RESISTANCE vs. CHANNEL TEMPERATURE

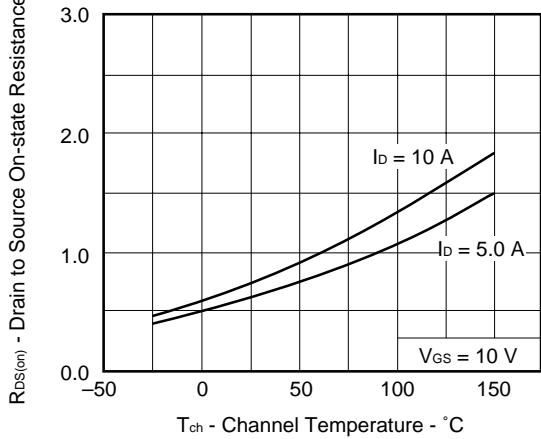

Figure12. SOURCE TO DRAIN DIODE FORWARD VOLTAGE

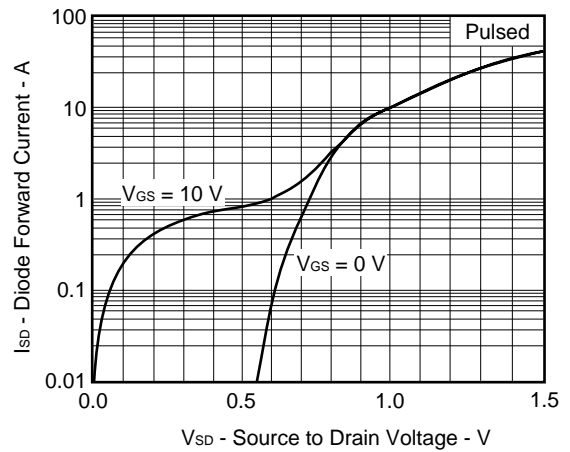

Figure13. CAPACITANCE vs. DRAIN TO SOURCE VOLTAGE

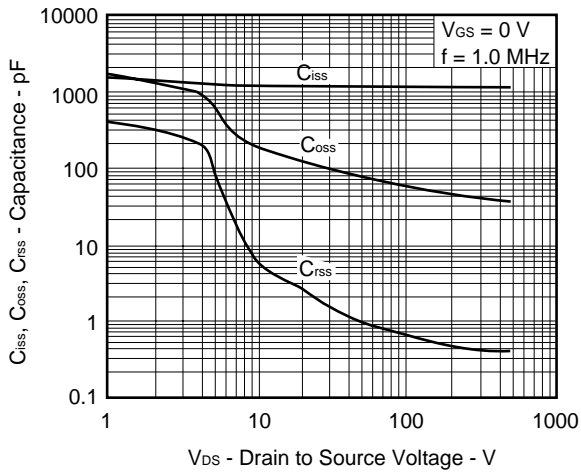

Figure14. SWITCHING CHARACTERISTICS

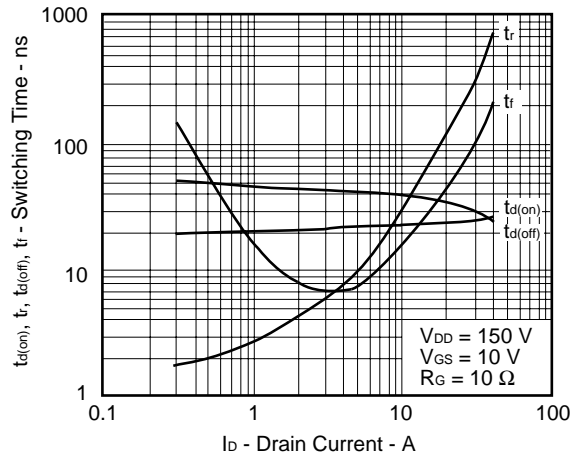

Figure15. REVERSE RECOVERY TIME vs. DRAIN CURRENT

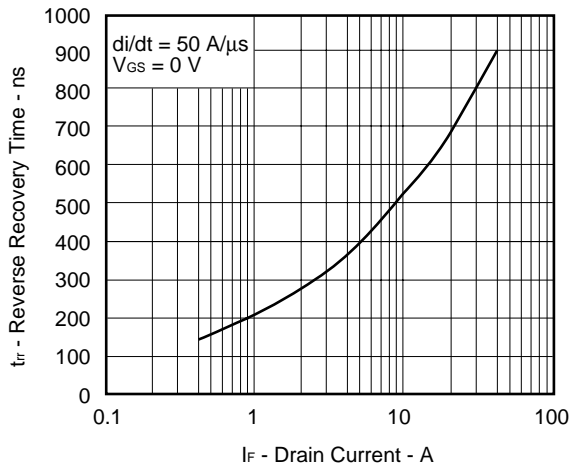
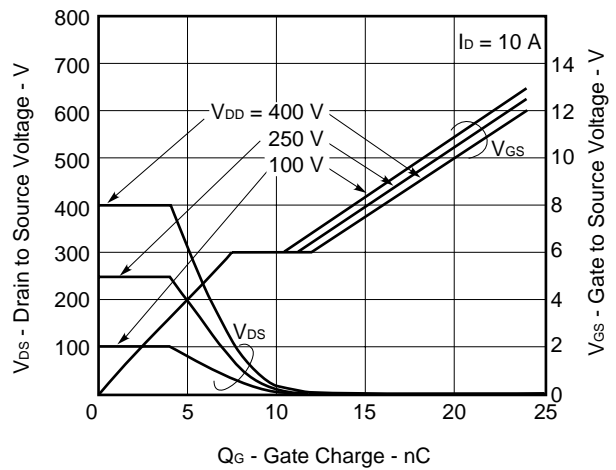

Figure16. DYNAMIC INPUT/OUTPUT CHARACTERISTICS



[查询"2SK3325-S"供应商](#)

Figure17. SINGLE AVALANCHE ENERGY vs STARTING CHANNEL TEMPERATURE

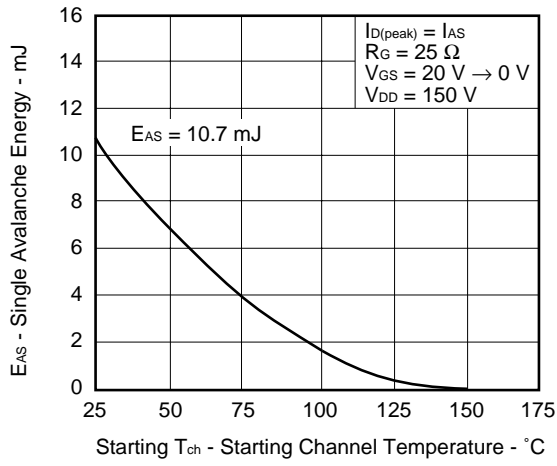
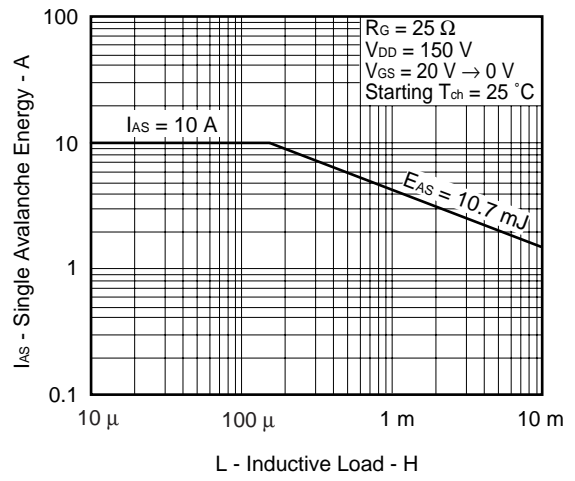
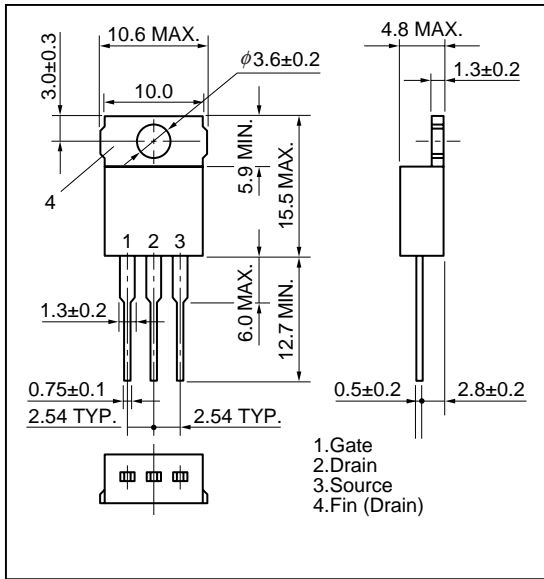

Figure18. SINGLE AVALANCHE ENERGY vs INDUCTIVE LOAD



李海"2SK3325"供应商
 PACKAGE DRAWINGS (Unit : mm)

1) TO-220AB (MP-25)



2) TO-262 (MP-25 Fin Cut)

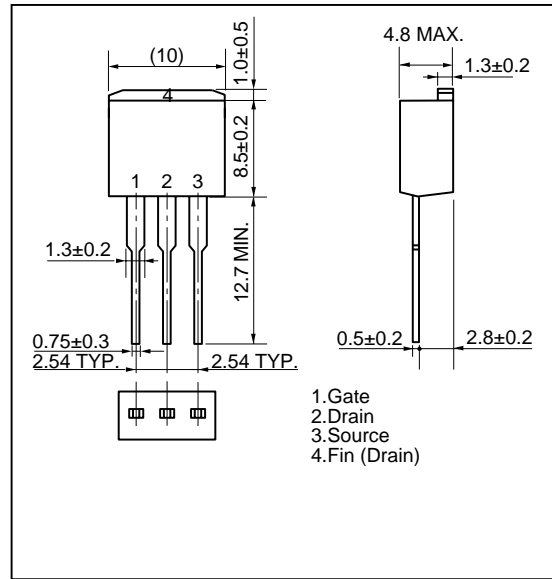

3) TO-263 (MP-25ZJ)

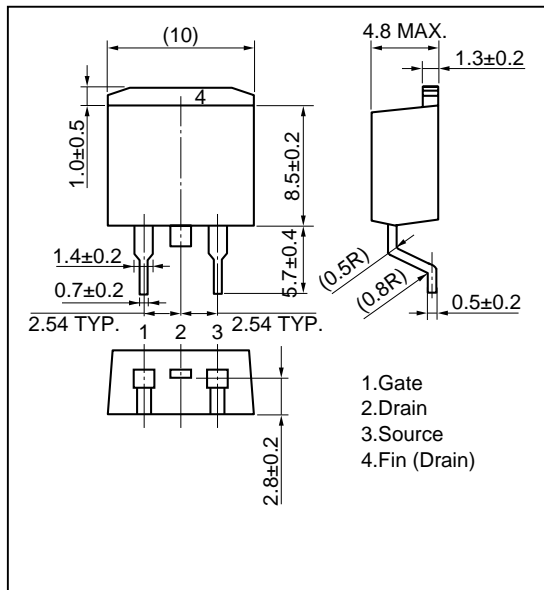

EQUIVALENT CIRCUIT

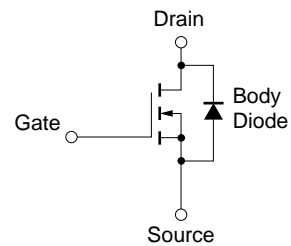

Remark Strong electric field, when exposed to this device, can cause destruction of the gate oxide and ultimately degrade the device operation. Steps must be taken to stop generation of static electricity as much as possible, and quickly dissipate it once, when it has occurred.

[查询"2SK3325-S"供应商](#)

- **The information in this document is current as of May, 2000. The information is subject to change without notice. For actual design-in, refer to the latest publications of NEC's data sheets or data books, etc., for the most up-to-date specifications of NEC semiconductor products. Not all products and/or types are available in every country. Please check with an NEC sales representative for availability and additional information.**
 - No part of this document may be copied or reproduced in any form or by any means without prior written consent of NEC. NEC assumes no responsibility for any errors that may appear in this document.
 - NEC does not assume any liability for infringement of patents, copyrights or other intellectual property rights of third parties by or arising from the use of NEC semiconductor products listed in this document or any other liability arising from the use of such products. No license, express, implied or otherwise, is granted under any patents, copyrights or other intellectual property rights of NEC or others.
 - Descriptions of circuits, software and other related information in this document are provided for illustrative purposes in semiconductor product operation and application examples. The incorporation of these circuits, software and information in the design of customer's equipment shall be done under the full responsibility of customer. NEC assumes no responsibility for any losses incurred by customers or third parties arising from the use of these circuits, software and information.
 - While NEC endeavours to enhance the quality, reliability and safety of NEC semiconductor products, customers agree and acknowledge that the possibility of defects thereof cannot be eliminated entirely. To minimize risks of damage to property or injury (including death) to persons arising from defects in NEC semiconductor products, customers must incorporate sufficient safety measures in their design, such as redundancy, fire-containment, and anti-failure features.
 - NEC semiconductor products are classified into the following three quality grades:
"Standard", "Special" and "Specific". The "Specific" quality grade applies only to semiconductor products developed based on a customer-designated "quality assurance program" for a specific application. The recommended applications of a semiconductor product depend on its quality grade, as indicated below. Customers must check the quality grade of each semiconductor product before using it in a particular application.
"Standard": Computers, office equipment, communications equipment, test and measurement equipment, audio and visual equipment, home electronic appliances, machine tools, personal electronic equipment and industrial robots
"Special": Transportation equipment (automobiles, trains, ships, etc.), traffic control systems, anti-disaster systems, anti-crime systems, safety equipment and medical equipment (not specifically designed for life support)
"Specific": Aircraft, aerospace equipment, submersible repeaters, nuclear reactor control systems, life support systems and medical equipment for life support, etc.
- The quality grade of NEC semiconductor products is "Standard" unless otherwise expressly specified in NEC's data sheets or data books, etc. If customers wish to use NEC semiconductor products in applications not intended by NEC, they must contact an NEC sales representative in advance to determine NEC's willingness to support a given application.
- (Note)
- (1) "NEC" as used in this statement means NEC Corporation and also includes its majority-owned subsidiaries.
 - (2) "NEC semiconductor products" means any semiconductor product developed or manufactured by or for NEC (as defined above).