

Category 5

High Speed

Single and Ganged Modular Jacks



FEATURES AND SPECIFICATIONS



**Category 5
High Speed
Single and Ganged
Modular Jacks**

Molex Incorporated offers single port and ganged high speed modular jacks for applications that require Category 5 or Category 5e reliability. These high speed jacks have been tested in accordance with EIA/TIA 568B standards and meet the performance criteria of greater than -43dB Near End Cross Talk (NEXT) at 100Mbps/100MHz for Category 5e performance.

Designed as an industry standard footprint and pin layout for Category 5, the RJ-45 modular jack layout is a drop in replacement for many modular jack suppliers. This provides for easy transition of the Molex Category 5 jacks to existing board layouts.

Features and Benefits

- Gigabit Ethernet compatible
- Delivers Category 5e performance to meet Near End Crosstalk (NEXT) requirements of greater than -43dB on all pair combinations at 100Mbps/100MHz
- Designed for fast Ethernet and ATM applications
- Low profile allows for tight board stacking
- Enhanced panel grounding tabs on shield provide a superior grounding path to panel or bracket
- Housing molded in 30% glass-filled nylon to maintain dimensional integrity to +260°C processing temperature for 1 minute
- 100% Hi-pot and continuity tested for electrical integrity
- Traditional industry standard footprint and pin layout

Enhanced tabs on the shield provide a superior ground path to the panel or metal bracket for maximum shielding effectiveness. Internal grounding tabs complete the circuit to ground in shielded cable/plug applications. Single port shields are available with two side panel grounding tabs or with one tab staggered on each side to allow for side-by-side stackability. Unshielded versions of both the single port and ganged high speed jacks are also available.

Applications

- Network Servers
- Hubs
- Routers
- Ethernet Switches
- Broadband Equipment
- Repeaters
- Premise Wiring
- Ethernet Telephony
- ATM Transmission Equipment

APPLICATIONS

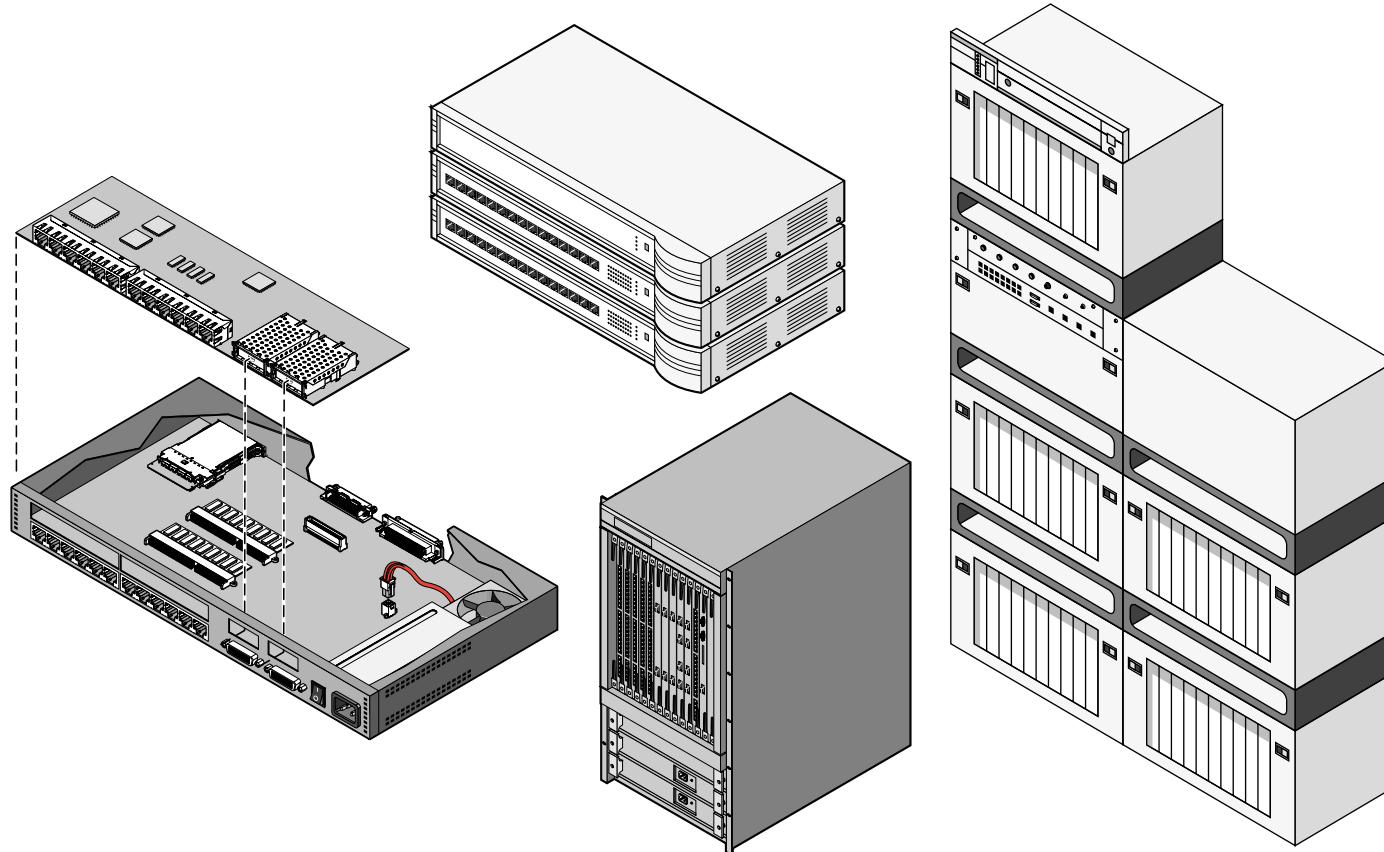

FEATURES AND SPECIFICATIONS

Features and Benefits

- Exceeds Category 5 performance
- Gigabit Ethernet compatible
- Enclosed top
- Industry Standard Footprint
- Shield with enhanced panel grounding tabs
- Surface Mount Compatible

Reference Information

Product Specification: PS-44050-003
 Packaging: Tray
 UL File No.: E107635
 CSA File No.: LR149980
 Designed In: Inches

Electrical

Voltage: 125V
 Current: 1.5A
 Dielectric Withstanding Voltage: 1000V AC
 Insulation Resistance: 500 MΩ min.

Mechanical

Durability: 500 cycles min.

Physical

Hog: Black glass-filled, high temperature nylon, UL 94V-0
 Plating: Contact Area—1.27µm (50µ") min. Gold
 Solder Tails—1.27µm (50µ") Tin/Lead
 On both contact area and solder tails over nickel overall
 Temperature: -40 to +80°C



44050

High Speed, Right Angle
 Low Profile
 Shielded and Unshielded
 Versions

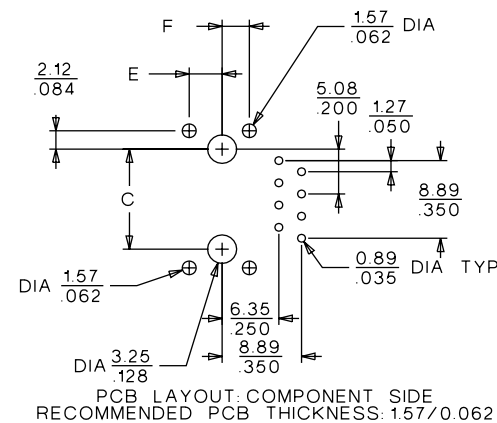
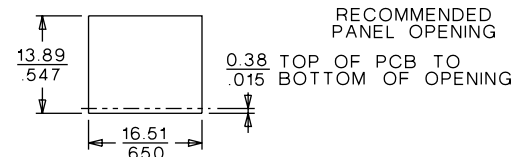
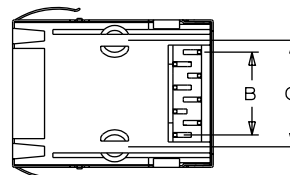
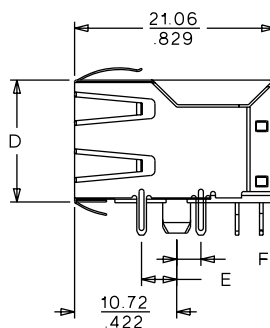
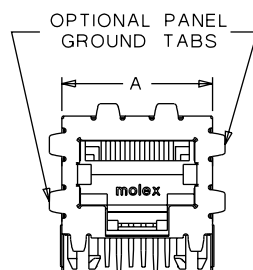
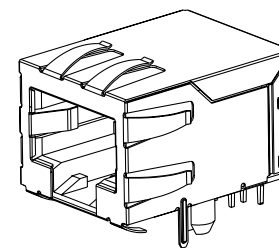

ORDERING INFORMATION AND DIMENSIONS

Circuits	Loaded Contacts	Order No.				Dimension						
		Unshielded	Shielded		Location E	Location F	A	B	C	D	E	F
			With All Panel Grounding Tabs	With Offset Panel Grounding Tabs								
8	8	44050-0001				15.24 (.600)	8.89 (.350)	11.43 (.450)	12.83 (.505)			
8	8		44050-0007		44050-0009	15.80 (.622)	8.89 (.350)	11.43 (.450)	13.08 (.515)	4.57 (.180)		
8	8		44050-0002		44050-0004	15.80 (.622)	8.89 (.350)	11.43 (.450)	13.08 (.515)	3.68 (.145)		
8	8		44050-0006		44050-0008	15.80 (.622)	8.89 (.350)	11.43 (.450)	13.08 (.515)	3.05 (.120)		
8	8			44050-0003		44050-0005	15.80 (.622)	8.89 (.350)	11.43 (.450)	13.08 (.515)		3.05 (.120)

FEATURES AND SPECIFICATIONS

Features and Benefits

- Exceeds Category 5 performance
- Gigabit Ethernet compatible
- 2, 4, 6 and 8 port configurations available
- Shield with enhanced panel grounding tabs
- 100% tested for hi-pot and continuity
- Industry Standard Footprint
- High-temperature plastic

Reference Information

Product Specification: PS-44150-003
 Packaging: Tray
 UL File No.: E107635
 CSA File No.: LR19980
 Designed In: Inches

Electrical

Voltage: 125V
 Current: 1.5A
 Dielectric Withstanding Voltage: 1000V AC
 Insulation Resistance: 500 MΩ min.

Mechanical

Durability: 500 cycles min.

Physical

Housing: Glass-filled nylon, UL 94V-0
 Plating: Contact Area—1.27µm (50µ") min. Gold
 Solder Tails—1.27µm (50µ") Tin/Lead
 On both contact area and solder tails over nickel overall
 Temperature: -40 to +80°C

44150

**High Speed, Ganged,
 Right Angle, Low Profile
 Shielded and Unshielded
 Versions**

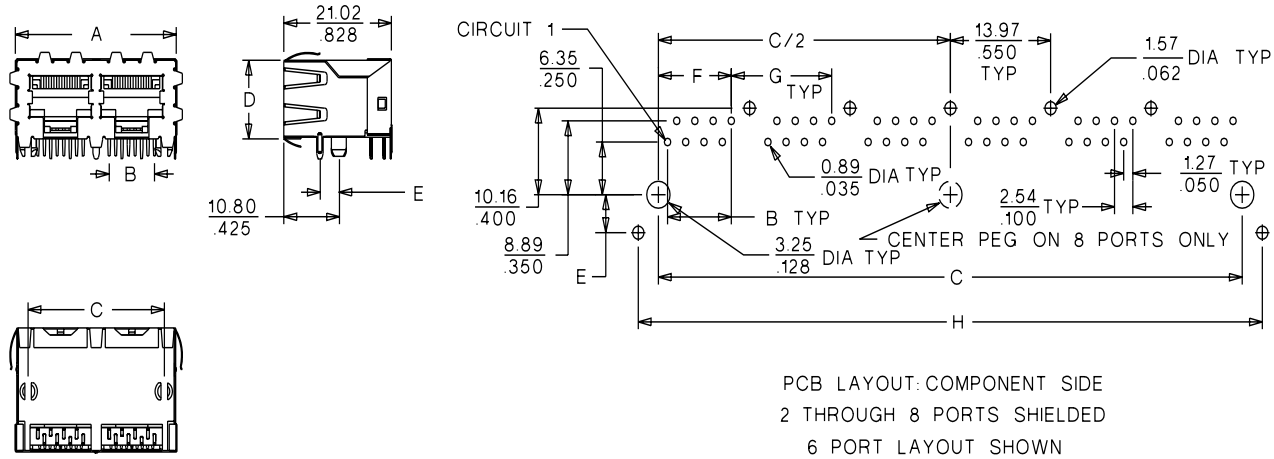
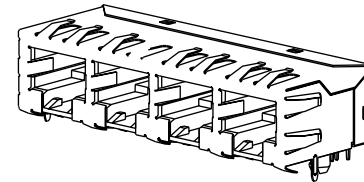

RECOMMENDED PCB THICKNESS: $\frac{1.57}{.062}$

ORDERING INFORMATION AND DIMENSIONS

Circuits	Loaded Contacts	No. of Ports	Order No.		Dimension					
			Snap-Fit Pegs	Press-Fit Pegs	A	B	C	D	F	G
8	8	2	44150-0001	44150-0017	30.48 (1.20)	8.89 (.350)	25.40 (1.00)	12.83 (.505)	10.16 (.400)	13.97 (.550)
8	8	4	44150-0002	44150-0018	58.42 (2.30)	8.89 (.350)	53.34 (2.10)	12.83 (.505)	10.16 (.400)	13.97 (.550)
8	8	6	44150-0003	44150-0019	86.36 (3.40)	8.89 (.350)	82.28 (3.20)	12.83 (.505)	10.16 (.400)	13.97 (.550)
8	8	8	44150-0004	44150-0020	114.30 (4.50)	8.89 (.350)	109.22 (4.30)	12.83 (.505)	10.16 (.400)	13.97 (.550)

Circuits	Loaded Contacts	No. of Ports	Order No.				Dimension						
			Option 1*		Option 2†		A	B	C	D	F	G	H
			Snap-Fit Pegs	Press-Fit Pegs	Snap-Fit Pegs	Press-Fit Pegs							
8	8	2	44150-0005	44150-0021	44150-0011	44150-0027	30.48 (1.20)	8.89 (.350)	25.40 (1.00)	13.31 (.524)	10.16 (.400)	13.97 (.550)	30.99 (1.22)
8	8	4	44150-0006	44150-0022	44150-0012	44150-0028	58.42 (2.30)	8.89 (.350)	53.34 (2.10)	13.31 (.524)	10.16 (.400)	13.97 (.550)	58.93 (2.32)
8	8	6	44150-0007	44150-0023	44150-0013	44150-0029	86.36 (3.40)	8.89 (.350)	82.28 (3.20)	13.31 (.524)	10.16 (.400)	13.97 (.550)	86.87 (3.42)
8	8	8	44150-0008	44150-0024	44150-0014	44150-0030	114.30 (4.50)	8.89 (.350)	109.22 (4.30)	13.31 (.524)	10.16 (.400)	13.97 (.550)	114.81 (4.52)

Note: Contact Inside Sales for alternative rear grounding tab option on 4 and 8 port order numbers only.

* Dimension E = 3.68mm (.145")

† Dimension E = 4.57mm (.180")

Americas Headquarters

Lisle, Illinois 60532 U.S.A.
 Tel: 1-800-78MOLEX
 Fax: 630-969-1352

Far East North Headquarters

Yamato, Kanagawa, Japan
 Tel: 81-462-65-2324
 Fax: 81-462-65-2366

Far East South Headquarters

Jurong, Singapore
 Tel: 65-268-6868
 Fax: 65-265-6044

European Headquarters

Munich, Germany
 Tel: 49-89-413092-0
 Fax: 49-89-401527

Corporate Headquarters

2222 Wellington Ct.
 Lisle, IL 60532 U.S.A.
 Tel: 630-969-4550

Visit our Web site at <http://www.molex.com>