

# SKBT 40

[查询"SKBT40"供应商](#)



**SEMIPONT® 2**

## Controllable Bridge Rectifiers

**SKBT 40**

### Features

- Fully controlled single phase bridge rectifier
- Robust plastic case with screw terminals
- Large, isolated base plate
- Blocking voltage to 1400V
- High surge currents
- Easy chassis mounting
- UL recognized, file no. E 63 532

### Typical Applications

- For reversing DC drives
- Controlled field rectifiers for DC motors
- Controlled battery charger rectifiers

1) Painted metal shield of minimum 250 x 250 x 1 mm:  $R_{th(c-a)} = 1,8 \text{ K/W}$

$V_{RSM}$ V	$V_{RRM}, V_{DRM}$ V	$I_D = 40 \text{ A (full conduction)}$ ( $T_c = 92 \text{ °C}$ )
800	800	SKBT 40/08
1200	1200	SKBT 40/12
1400	1400	SKBT 40/14

Symbol	Conditions	Values	Units
$I_D$	$T_c = 85 \text{ °C}$	46	A
	$T_a = 45 \text{ °C; chassis } ^1)$	15	A
	$T_a = 45 \text{ °C; R4A/120}$	18	A
	$T_a = 45 \text{ °C; P13A/125}$	18	A
	$T_a = 45 \text{ °C; P1A/120}$	28	A
$I_{TSM}, I_{FSM}$	$T_{vj} = 25 \text{ °C; } 10 \text{ ms}$	470	A
	$T_{vj} = 125 \text{ °C; } 10 \text{ ms}$	400	A
$i^2t$	$T_{vj} = 25 \text{ °C; } 8,3 \dots 10 \text{ ms}$	1100	A <sup>2</sup> s
	$T_{vj} = 125 \text{ °C; } 8,3 \dots 10 \text{ ms}$	800	A <sup>2</sup> s
$V_T$	$T_{vj} = 25 \text{ °C; } I_T = 75 \text{ A}$	max. 2,3	V
$V_{T(TO)}$	$T_{vj} = 125 \text{ °C;}$	max. 1	V
$r_T$	$T_{vj} = 125 \text{ °C}$	max. 16	mΩ
$I_{DD}, I_{RD}$	$T_{vj} = 125 \text{ °C; } V_{DD} = V_{DRM}; V_{RD} = V_{RRM}$	max. 10	mA
$t_{gd}$	$T_{vj} = 25 \text{ °C; } I_G = 1 \text{ A; } di_G/dt = 1 \text{ A/}\mu\text{s}$	1	μs
$t_{gr}$	$V_D = 0,67 \cdot V_{DRM}$	1	μs
$(dv/dt)_{cr}$	$T_{vj} = 125 \text{ °C}$	max. 500	V/μs
$(di/dt)_{cr}$	$T_{vj} = 125 \text{ °C; } f = 50 \text{ Hz}$	max. 50	A/μs
$t_q$	$T_{vj} = 125 \text{ °C; typ.}$	80	μs
$I_H$	$T_{vj} = 25 \text{ °C; typ. / max.}$	100 / 200	mA
$I_L$	$T_{vj} = 25 \text{ °C; } R_G = 33 \text{ }\Omega$	250 / 400	mA
$V_{GT}$	$T_{vj} = 25 \text{ °C; d.c.}$	min. 3	V
$I_{GT}$	$T_{vj} = 25 \text{ °C; d.c.}$	min. 150	mA
$V_{GD}$	$T_{vj} = 125 \text{ °C; d.c.}$	max. 0,25	V
$I_{GD}$	$T_{vj} = 125 \text{ °C; d.c.}$	max. 5	mA
$R_{th(j-c)}$	per thyristor / diode	1	K/W
	total	0,25	K/W
$R_{th(c-s)}$	total	0,05	K/W
$T_{vj}$		- 40 ... + 125	°C
$T_{stg}$		- 40 ... + 125	°C
$V_{isol}$	a. c. 50 Hz; r.m.s.; 1 s / 1 min.	3600 ( 3000 )	V
$M_s$	to heatsink	5	Nm
$M_t$	to terminals	3	Nm
$m$		165	g
Case	SKBT	G 20	

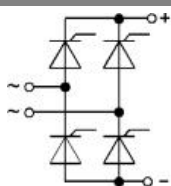

**SKBT**

[查询"SKBT40"供应商](#)

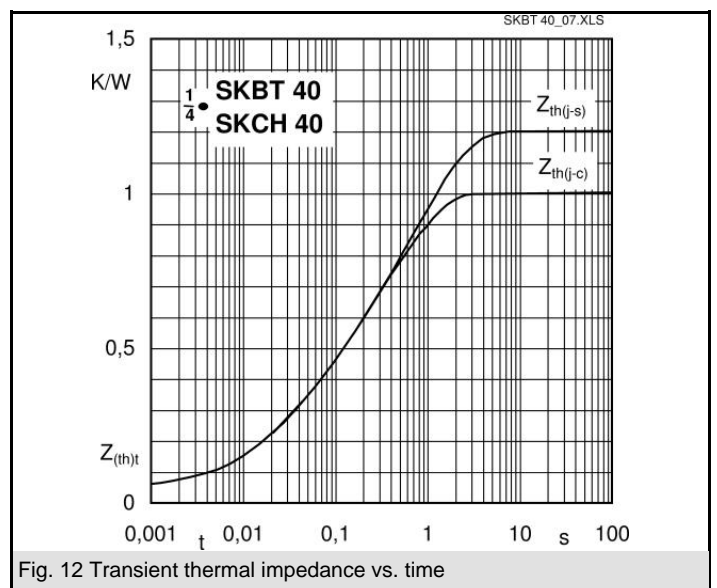
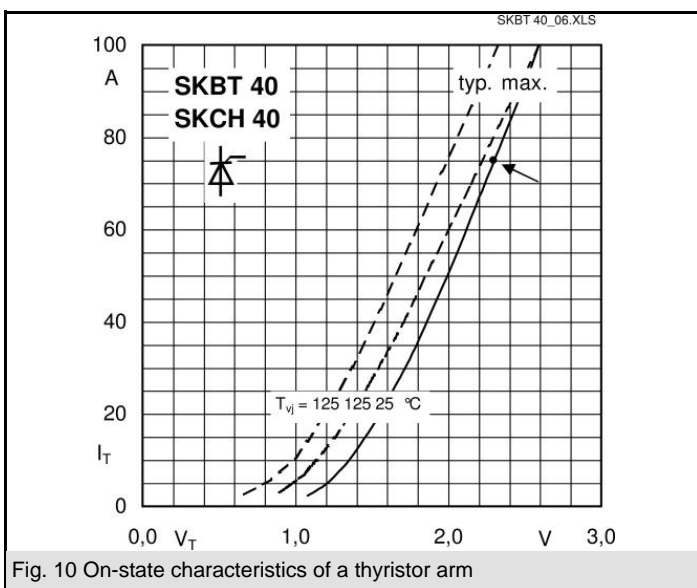
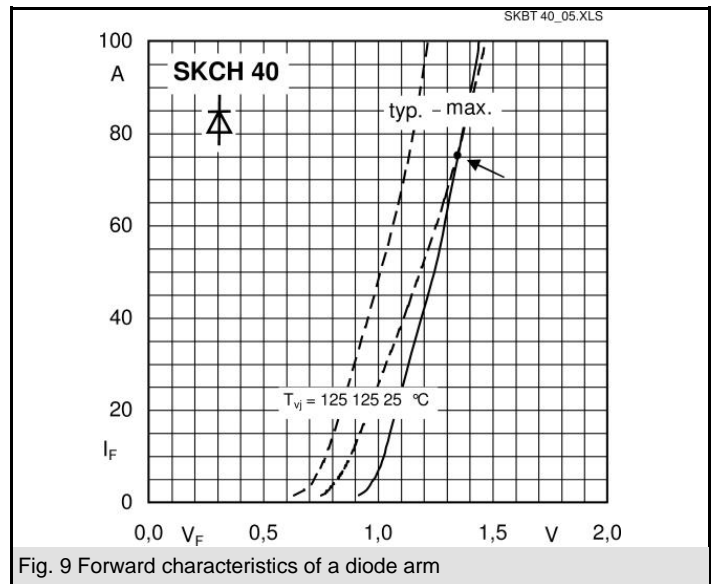
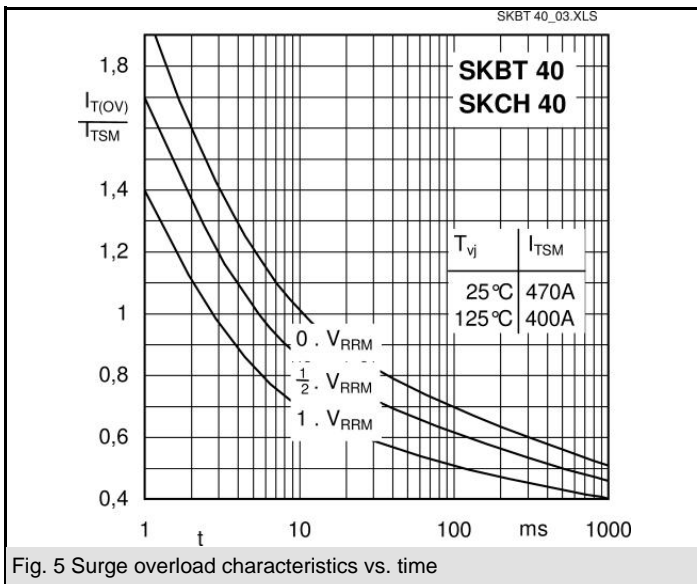
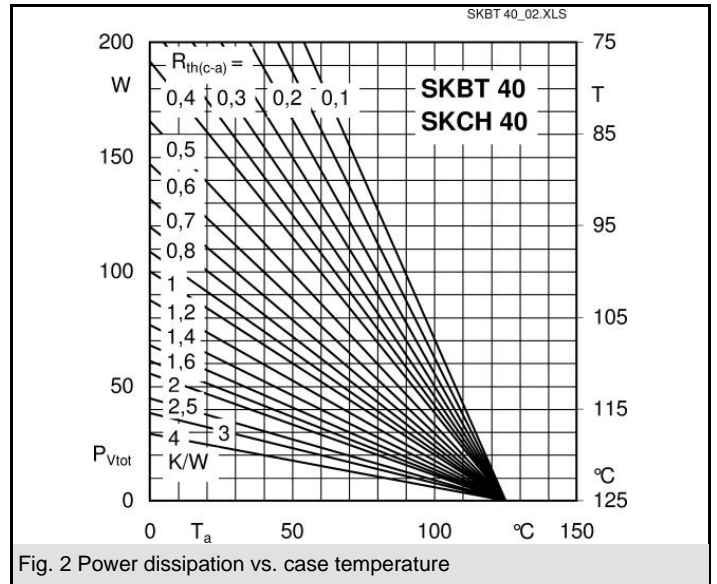
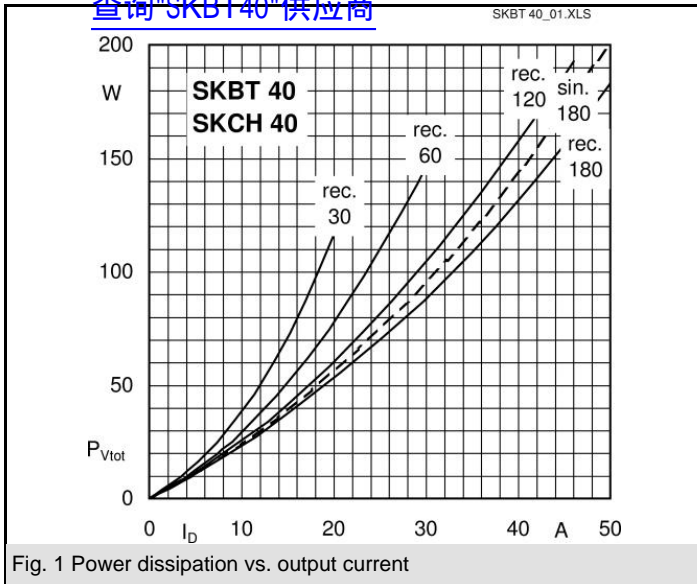

# SKBT 40

[查询"SKBT40"供应商](#)

SKBT 40\_11.XLS

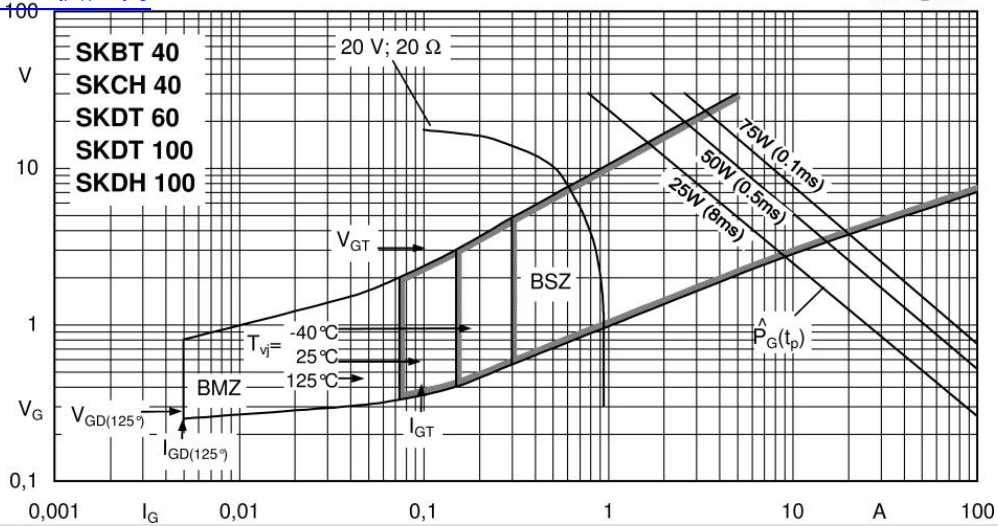
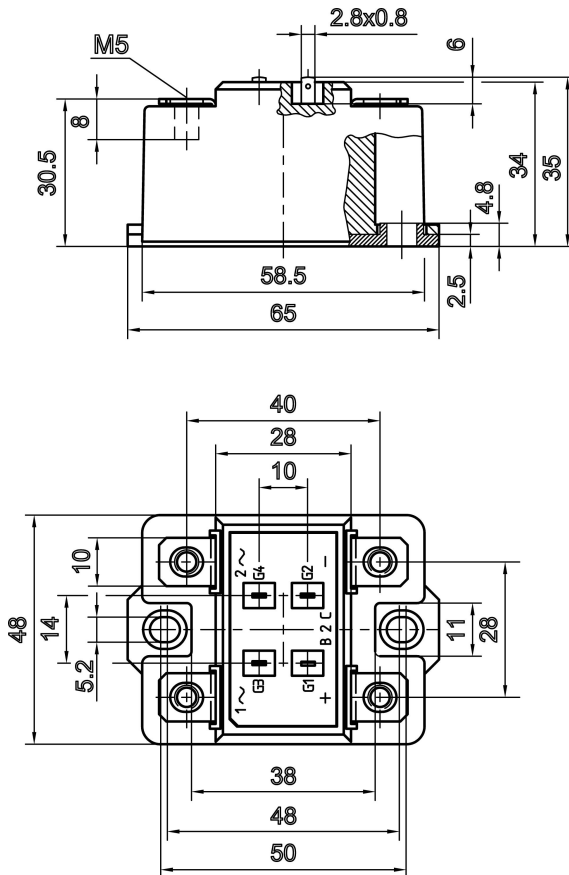

Fig. 11 Gate characteristics of a thyristor device

Dimensions in mm



Case G 20

This technical information specifies semiconductor devices but promises no characteristics. No warranty or guarantee expressed or implied is made regarding delivery, performance or suitability.