

[查询"A1210B"供应商](#)



Series 1

10-90Amp • 120, 240 Vac • AC Output

- Zero Voltage and Random Turn-On Switching
- Panel Mount
- 600V Blocking Capability
- Internal Snubber
- 110 & 125A Models Available

Featuring state-of-the-art Surface Mount Technology, these SFST-NO relays deliver proven reliability in the most demanding applications. Output consists of an SCR AC switch and is available in zero-cross, random turn-on (phase controllable) and normally closed (Form B) versions with either AC or DC input (coil) control.

Manufactured in Crydom's ISO 9002 Certified facility for optimum product performance and reliability.

MODEL NUMBERS	AC CONTROL	A1210	A1225	A1240	A2410	A2425	A2450	A2475	A2490
OUTPUT SPECIFICATIONS ①	DC CONTROL	D1210	D1225	D1240	D2410	D2425	D2450	D2475	D2490
Operating Voltage (47-63 Hz) [Vrms]		24-140	24-140	24-140	24-280	24-280	24-280	24-280	24-280
Max. Load Current ③ [Arms]		10	25	40	10	25	50	75	90
Min. Load Current, [mArms]		40	40	40	40	40	40	40	40
Transient Overvoltage [Vpk]		400	400	400	600	600	600	600	600
Max. Surge Current, (16.6ms) [Apk]		120	250	625	120	250	625	1000	1200
Max. On-State Voltage Drop @Rated Current [Vpk]		1.6	1.6	1.6	1.6	1.6	1.6	1.6	1.6
Thermal Resistance Junction to Case ($R_{\theta JC}$) [°C/W]		1.48	1.02	0.63	1.48	1.02	0.63	0.31	0.28
Maximum $I^2 t$ for Fusing, (8.3 msec.) [A ² sec]		60	260	1620	60	260	1620	4150	6000
Max. Off-State Leakage Current @Rated Voltage [mArms]		8	8	8	10	10	10	10	10
Min. Off-State dv/dt @Max. Rated Voltage [V/μsec]②		500	500	500	500	500	500	500	500
Max. Turn-On Time ④		1/2 Cycle (DC Control), 10.0 msec (AC Control)							
Max. Turn-Off Time		1/2 Cycle (DC Control), 40.0 msec (AC Control)							
Power Factor (Min.) with Max. Load		0.5	0.5	0.5	0.5	0.5	0.5	0.5	0.5

INPUT SPECIFICATIONS ①	DC CONTROL	AC CONTROL	AC CONTROL (E SUFFIX)
Control Voltage Range	3-32 Vdc	90-280 Vrms (60Hz)	18-36 Vrms
Max. Reverse Voltage	-32 Vdc	—	—
Max. Turn-On Voltage	3.0 Vdc	90 Vrms	18 Vrms
Min. Turn-Off Voltage	1.0 Vdc	10 Vrms	4.0 Vrms
Nominal Input Impedance	1500 Ohms	60K Ohms	9.0K Ohms
Typical Input Current	3.4mA @5 Vdc, 20mA @28Vdc	2mA @120 Vrms, 4mA @240 Vrms	3mA @24 Vrms

©1998 CRYDOM CORP, Specifications subject to change without notice.

GENERAL NOTES

- ① All parameters at 25°C unless otherwise specified.
- ② Off-State dv/dt test method per EIA/NARF standard RS-443, paragraph 13.11.1
- ③ Heat sinking required, for derating curves see page 2.
- ④ Turn-on time for random turn-on versions is 0.02 msec (DC Control Models).

For recommended applications and more information contact:

USA: (800) 8 CRYDOM • (800) 827-9366 • (619) 715-7200 • fax (619) 715-7280
Crydom Corp, 9525 Chesapeake Drive, San Diego, CA 92123 • e-mail: sales@crydom.com
WEB SITE: <http://www.crydom.com> FASTFAX Product Information: (888) 267-9191
UK: (44)1202 812300 • fax (44)1202 812340 Crydom International Ltd., 85, Condor Close,
Woolbridge Industrial Estate, Three-Legged Cross, Wimborne, Dorset, England BH21 6SU
GERMANY: (49) (0)6874 182580 • fax (49)(0)6874 182585 Crydom GmbH,
Gewerbegebiet Im Schachen, D-66687 Nunkirchen, Germany • e-mail: vertrieb@crydom.com



[查询"A1210B"供应商](#)



Series 1

10-90Amp • 120, 240 Vac • AC Output

GENERAL SPECIFICATIONS

Dielectric Strength 50/60Hz Input/Output/Base	4000 Vrms
Insulation Resistance (Min.) @500 Vdc	10 ⁹ Ohm
Max. Capacitance Input/Output	8 pF
Ambient Operating Temperature Range	-40 to 80°C
Ambient Storage Temperature Range	-40 to 125°C

MECHANICAL SPECIFICATIONS

Weight: (typical)	3.0 oz. (86.5g)
Encapsulation:	Thermally Conductive Epoxy
Terminals:	Screws and Saddle Clamps Furnished, Unmounted

AVAILABLE OPTIONS

- B** Normally Closed (Form B)
Example: **D2450-B, A2450-B**
- 4D** 400 Hz Operation
10-50 Amp Models Only
Zero Cross Switching Only
Example: **4D2450**
- E** 24 Vac Input (18-36 Vac)
Example: **A2450E**
- 10** Random Turn-On (AC & DC Control)
Phase Controllable (DC Control)
Example: **D2450-10**
- F** Faston Terminals (Up to 50A Models)
.250 x .032 Faston Terminals
Example: **D1225F**

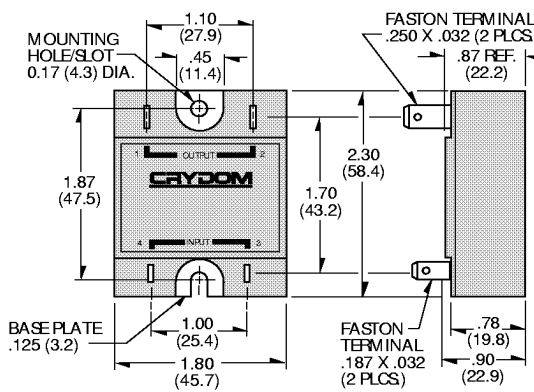
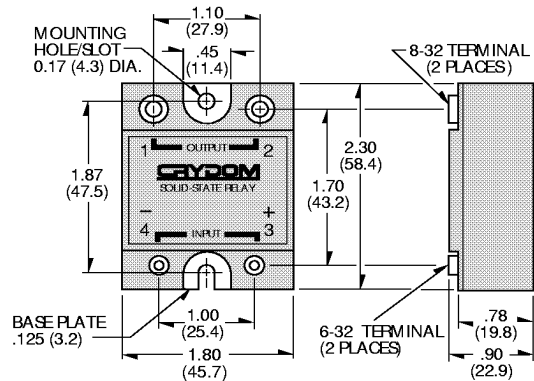

Screw Torque Requirements:
6-32 Screws - 10 in./lbs.,
8-32 and 10-32 Screws - 20 in./lbs.
(Screws dry without grease.)

Fastons:
Single pair (up to 25A)
Double pair* (up to 50A).
*Caution: User must connect to both pairs

Crydom Heat Sinks offer excellent thermal management and are perfectly matched to the load current ratings of Crydom panel mount relays. Request Crydom's Heat Sink specification sheet for all the details.

All dimensions are in inches (millimeters)

APPROVALS

UL E116949
CSA LF81689
VDE 10143 UG (Not Applicable: -B and 4D)



FastFax Document No.151
SERIES1.032698, PAGE 2 OF 3

©1998 CRYDOM CORP, Specifications subject to change without notice.

For recommended applications and more information contact:
USA: (800) 8 CRYDOM • (800) 827-9366 • (619) 715-7200 • fax (619) 715-7280
Crydom Corp, 9525 Chesapeake Drive, San Diego, CA 92123 • e-mail: sales@crydom.com
WEB SITE: <http://www.crydom.com> **FASTFAX Product Information:** (888) 267-9191
UK: (44)1202 812300 • fax (44)1202 812340 Crydom International Ltd., 85, Condor Close,
Woolbridge Industrial Estate, Three-Legged Cross Wimborne, Dorset, England BH21 6SU
GERMANY: (49) (0)6874 182580 • fax (49)(0)6874 182585 Crydom GmbH,
Gewerbegebiet Im Schachen, D-66687 Nunkirchen, Germany • e-mail: Vertrieb@crydom.com



查询"A1210B"供应商

Series 1

10-90Amp • 120, 240 Vac • AC Output

CRYDOM

Control over power

CURRENT DERATING CURVES

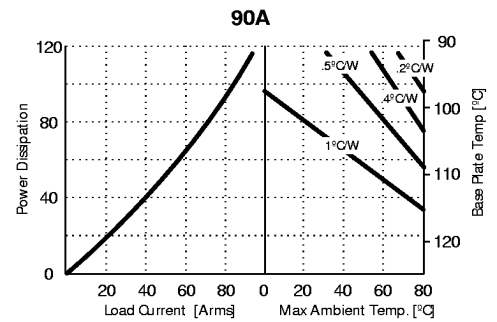
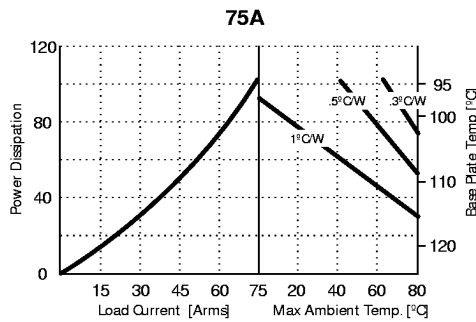
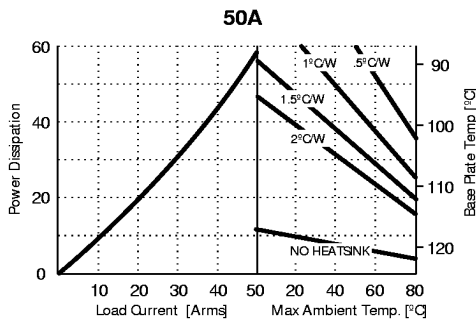
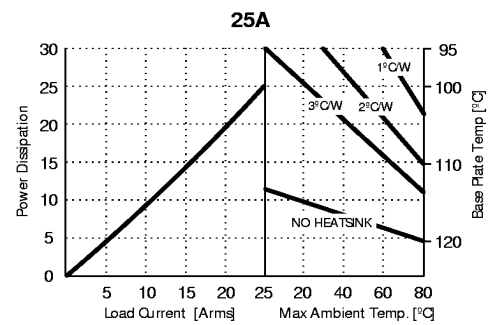
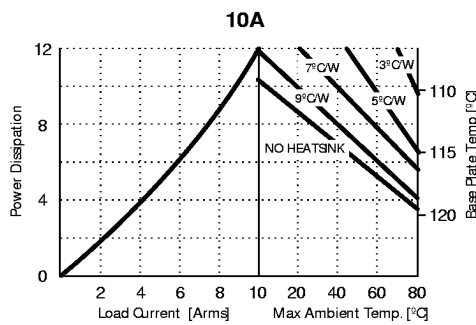

©1998 CRYDOM CORP, Specifications subject to change without notice.

For recommended applications and more information contact:

USA: (800) 8 CRYDOM • (800) 827-9366 • (619) 715-7200 • fax (619) 715-7280

Crydom Corp, 9525 Chesapeake Drive, San Diego, CA 92123 • e-mail: sales@crydom.com

WEB SITE: <http://www.crydom.com> FASTFAX Product Information: (888) 267-9191

UK: (44)1202 812300 • fax (44)1202 812340 Crydom International Ltd., 85, Condor Close,

Woolbridge Industrial Estate, Three-Legged Cross, Wimborne, Dorset, England BH21 6SU

GERMANY: (49) (0)6874 182580 • fax (49)(0)6874 182585 Crydom GmbH,

Gewerbegebiet Im Schachen, D-66687 Nunkirchen, Germany • e-mail: vertrieb@crydom.com

