

Features

- Low On-Resistance
 - 95mΩ @V_{GS} = -4.5V
 - 120mΩ @V_{GS} = -2.5V
 - 86mΩ (typ) @V_{GS} = -1.8V
- Low Gate Threshold Voltage, -1.3V Max
- Fast Switching Speed
- Low Input/Output Leakage
- Incorporates Low V_F Super Barrier Rectifier (SBR[®])
- Low Profile, 0.5mm Max Height
- Lead Free/RoHS Compliant (Note 2)
- "Green" Device (Note 3)
- Qualified to AEC-Q101 Standards for High Reliability

Mechanical Data

- Case: DFN2020B-6
- Case Material: Molded Plastic, "Green" Molding Compound. UL Flammability Classification Rating 94V-0
- Moisture Sensitivity: Level 1 per J-STD-020D
- Terminal Connections: See Diagram
- Terminals: Finish – NiPdAu over Copper leadframe. Solderable per MIL-STD-202, Method 208
- Marking Information: See Page 6
- Ordering Information: See Page 6
- Weight: 0.0065 grams (approximate)

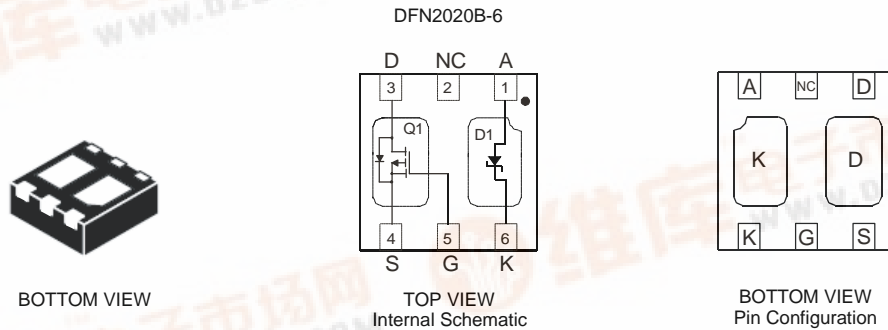

Maximum Ratings – TOTAL DEVICE @T_A = 25°C unless otherwise specified

Characteristic	Symbol	Value	Unit
Power Dissipation (Note 1)	P _D	1.4	W
Thermal Resistance, Junction to Ambient	R _{θJA}	89	°C/W
Operating and Storage Temperature Range	T _J , T _{STG}	-55 to +150	°C

Maximum Ratings – P-CHANNEL MOSFET – Q1 @T_A = 25°C unless otherwise specified

Characteristic	Symbol	Value	Units
Drain-Source Voltage	V _{DSS}	-20	V
Gate-Source Voltage	V _{GSS}	±12	V
Drain Current (Note 1)	I _D	-3.5	A
Pulsed Drain Current (Note 4)	I _{DM}	-12	A

Maximum Ratings – SBR[®] – D1 @T_A = 25°C unless otherwise specified

Characteristic	Symbol	Value	Unit
Peak Repetitive Reverse Voltage	V _R RM	35	V
Working Peak Reverse Voltage	V _R WM		
DC Blocking Voltage	V _R		
RMS Reverse Voltage	V _{R(RMS)}	25	V
Average Rectified Output Current	I _O	1	A
Non-Repetitive Peak Forward Surge Current 8.3ms single half sine-wave superimposed on rated load	I _{FSM}	3	A

- Notes:
1. Device mounted on FR-4 PCB, on minimum recommended, 2oz Copper pad layout.
 2. No purposefully added lead.
 3. Diodes Inc.'s "Green" policy can be found on our website at http://www.diodes.com/products/lead_free/index.php.
 4. Repetitive rating, pulse width limited by junction temperature.



Electrical Characteristics – P-CHANNEL MOSFET – Q1 @ T_A = 25°C unless otherwise specified

Characteristic	Symbol	Min	Typ	Max	Unit	Test Condition
OFF CHARACTERISTICS (Note 5)						
Drain-Source Breakdown Voltage	BV _{DSS}	-20	—	—	V	V _{GS} = 0V, I _D = -250μA
Zero Gate Voltage Drain Current	I _{DSS}	—	—	-1	μA	V _{DS} = -20V, V _{GS} = 0V
Gate-Source Leakage	I _{GSS}	—	—	±100 ±800	nA	V _{GS} = ±8V, V _{DS} = 0V V _{GS} = ±12V, V _{DS} = 0V
ON CHARACTERISTICS (Note 5)						
Gate Threshold Voltage	V _{GS(th)}	-0.45	—	-1.3	V	V _{DS} = V _{GS} , I _D = -250μA
Static Drain-Source On-Resistance	R _{DS(ON)}	—	60	95	mΩ	V _{GS} = -4.5V, I _D = -2.8A
		—	74	120		V _{GS} = -2.5V, I _D = -2.0A
		—	86	—		V _{GS} = -1.8V, I _D = -1.0A
Forward Transfer Admittance	Y _{fs}	—	8	—	S	V _{DS} = -5V, I _D = -2.8A
Diode Forward Voltage (Note 5)	V _{SD}	—	0.7	-1.2	V	V _{GS} = 0V, I _S = -1.6A
DYNAMIC CHARACTERISTICS						
Input Capacitance	C _{iss}	—	632	—	pF	V _{DS} = -10V, V _{GS} = 0V f = 1.0MHz
Output Capacitance	C _{oss}	—	65	—	pF	
Reverse Transfer Capacitance	C _{rss}	—	54	—	pF	

Electrical Characteristics – SBR[®] – D1 @ T_A = 25°C unless otherwise specified

Characteristic	Symbol	Min	Typ	Max	Unit	Test Condition
Reverse Breakdown Voltage (Note 5)	V _{(BR)R}	35	40	—	V	I _R = 1mA
Forward Voltage	V _F	—	354	0.42	V	I _F = 0.5A
		—	415	0.49		I _F = 1.0A
Reverse Current (Note 5)	I _R	—	—	100	μA	V _R = 20V

Notes: 5. Short duration pulse test used to minimize self-heating effect.

Q1, P-CHANNEL MOSFET

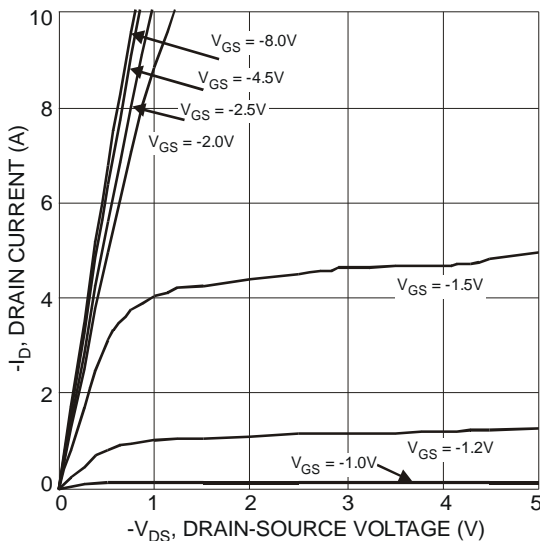

Fig. 1 Typical Output Characteristics

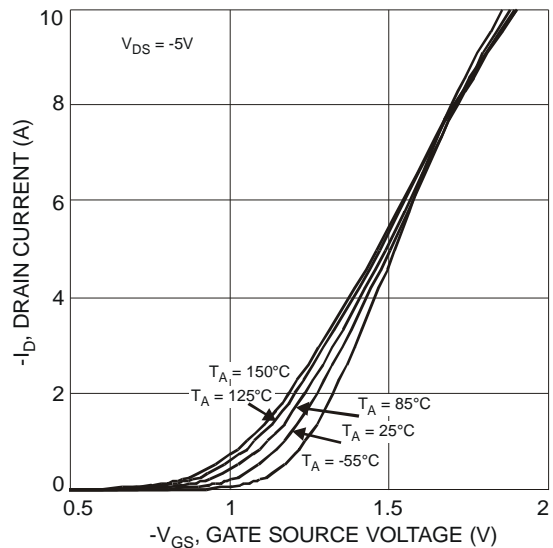

Fig. 2 Typical Transfer Characteristics

SBR is a registered trademark of Diodes Incorporated.

Q1, P-CHANNEL MOSFET - Continued

NEW PRODUCT

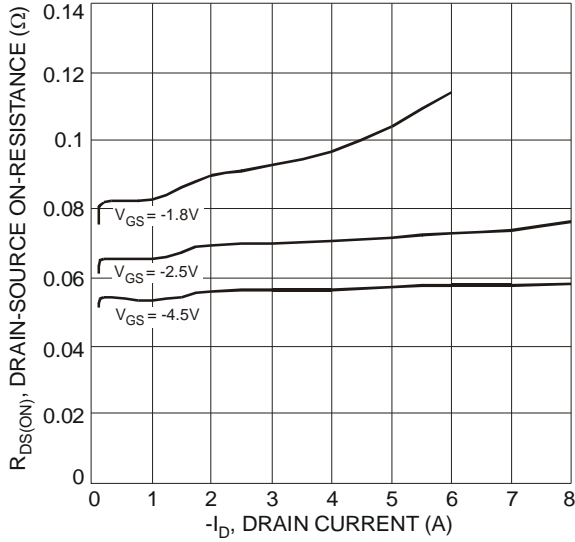

Fig. 3 Typical On-Resistance vs. Drain Current and Gate Voltage

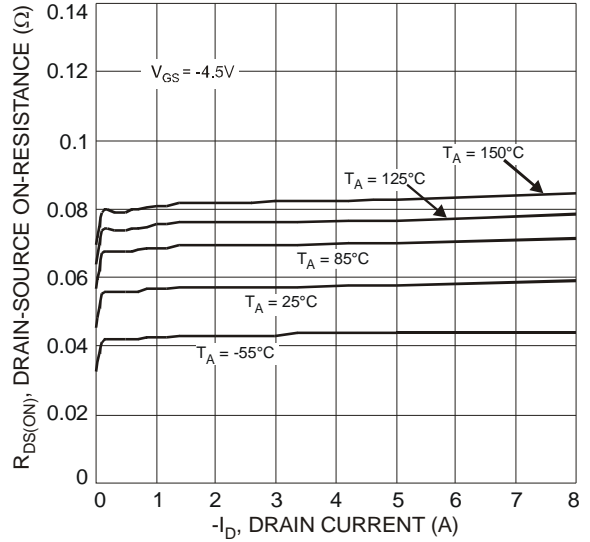

Fig. 4 Typical Drain-Source On-Resistance vs. Drain Current and Temperature

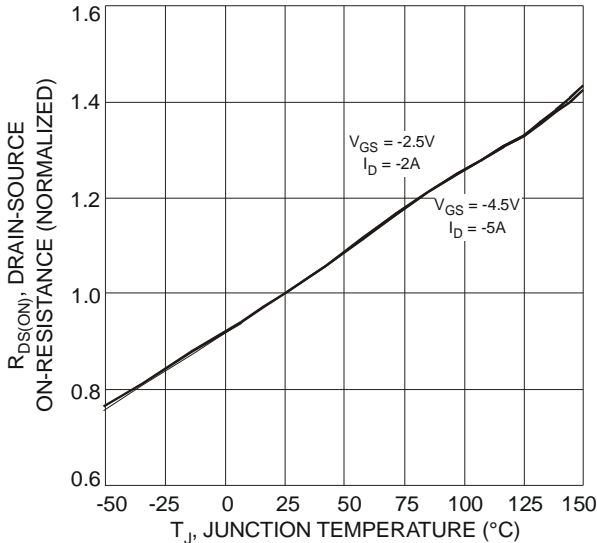

Fig. 5 On-Resistance Variation with Temperature

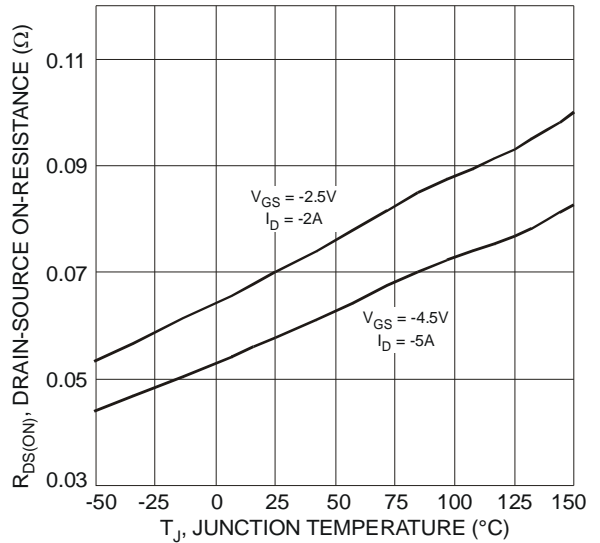

Fig. 6 On-Resistance Variation with Temperature

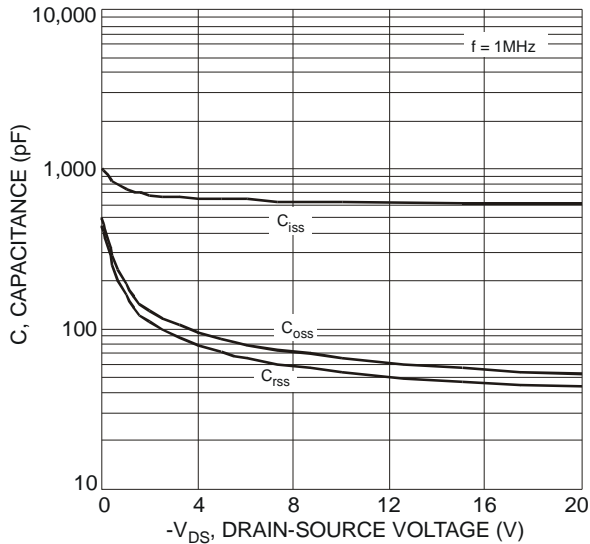

Fig. 7 Typical Capacitance

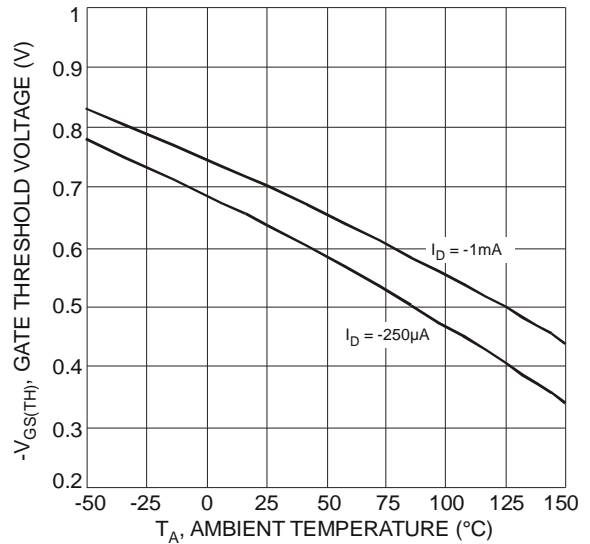

Fig. 8 Gate Threshold Variation vs. Ambient Temperature

SBR is a registered trademark of Diodes Incorporated.

Q1, P-CHANNEL MOSFET - Continued

NEW PRODUCT

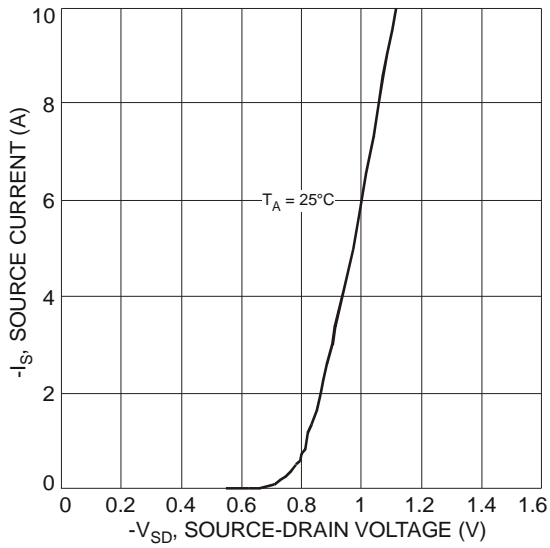

Fig. 9 Diode Forward Voltage vs. Current

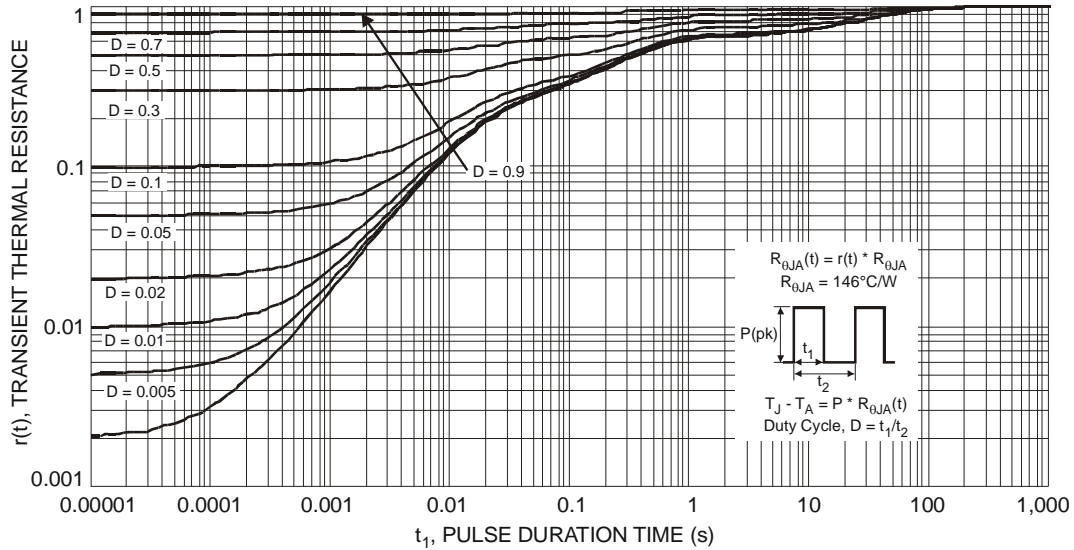

Fig. 10 Transient Thermal Response

D1, SBR®

NEW PRODUCT

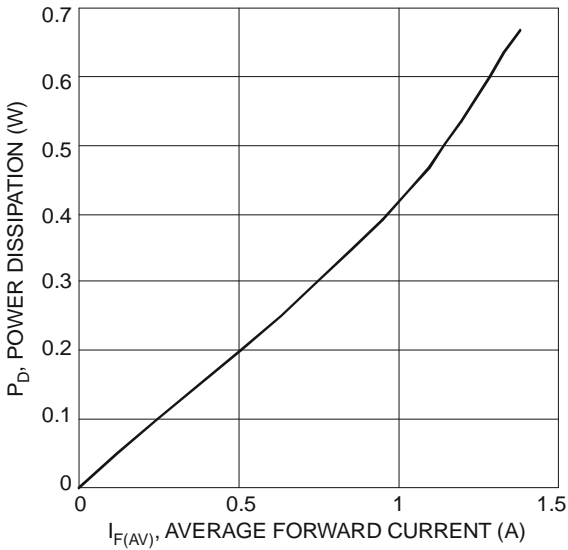

Fig. 11 Forward Power Dissipation

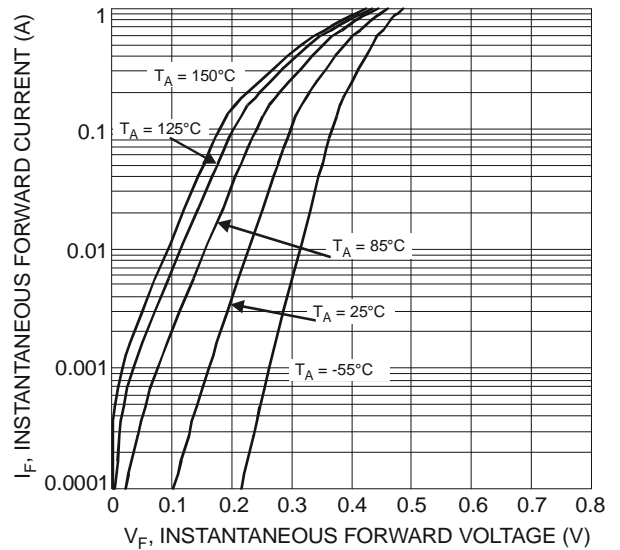

Fig. 12 Typical Forward Characteristics

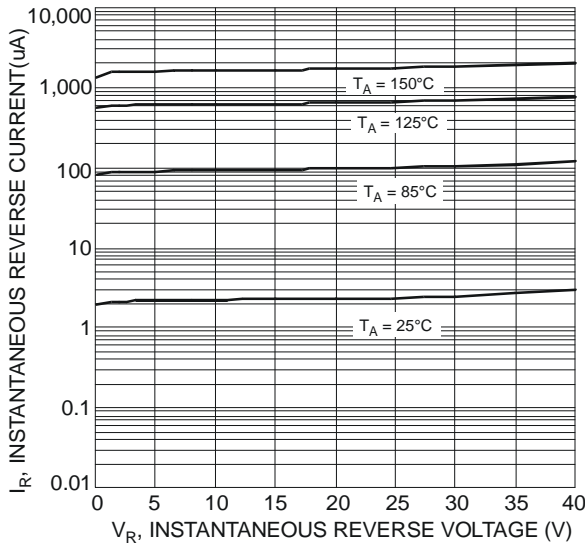

Fig. 13 Typical Reverse Characteristics

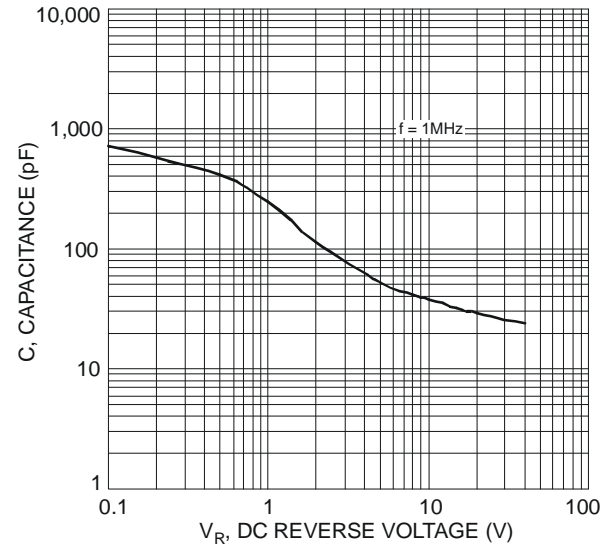

Fig. 14 Total Capacitance vs. Reverse Voltage

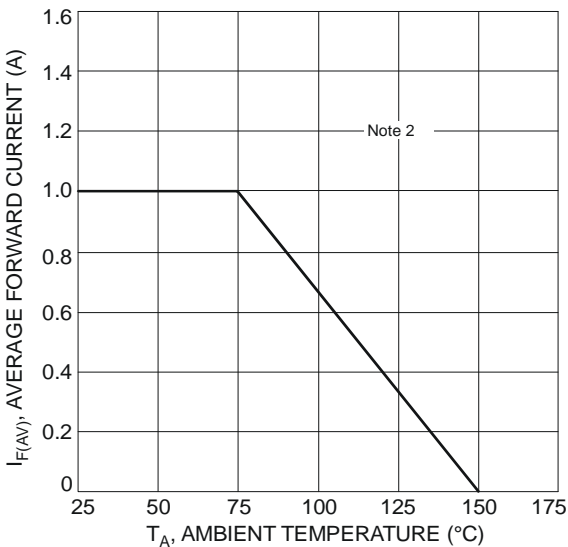

Fig. 15 Forward Current Derating Curve

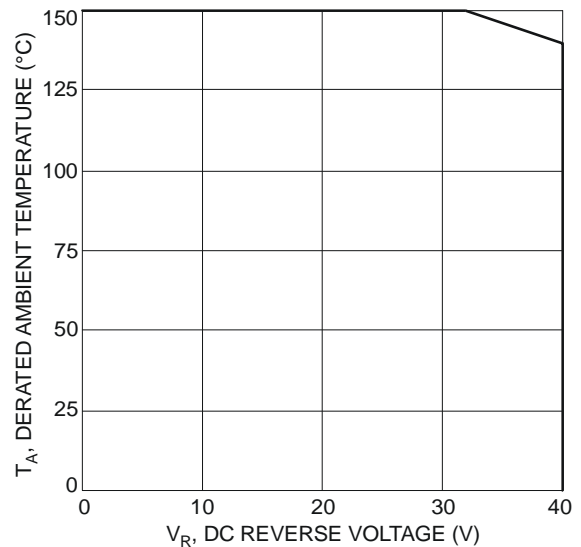

Fig. 16 Operating Temperature Derating

SBR is a registered trademark of Diodes Incorporated.

Ordering Information (Note 6)

Part Number	Case	Packaging
DMS2220LFDB-7	DFN2020B-6	3000/Tape & Reel

 Notes: 6. For packaging details, go to our website at <http://www.diodes.com/datasheets/ap02007.pdf>.

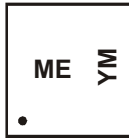
Marking Information

ME = Marking Code
 YM = Date Code Marking
 Y = Year (ex: V = 2008)
 M = Month (ex: 9 = September)
 Dot denotes Pin 1

Date Code Key

Year	2008	2009	2010	2011	2012	2013	2014	2015
Code	V	W	X	Y	Z	A	B	C

Month	Jan	Feb	Mar	Apr	May	Jun	Jul	Aug	Sep	Oct	Nov	Dec
Code	1	2	3	4	5	6	7	8	9	O	N	D

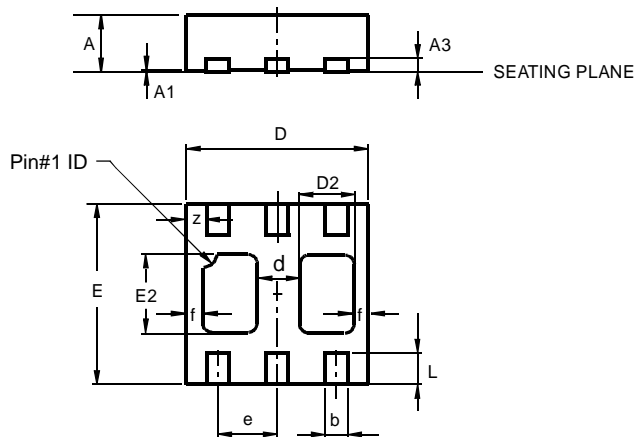
Package Outline Dimensions

DFN2020B-6			
Dim	Min	Max	Typ
A	0.47	0.53	0.50
A1	0	0.05	0.02
A3	—	—	0.13
b	0.20	0.30	0.25
D	1.95	2.075	2.00
d	—	—	0.45
D2	0.50	0.70	0.60
e	—	—	0.65
E	1.95	2.075	2.00
E2	0.90	1.10	1.00
f	—	—	0.15
L	0.25	0.35	0.30
z	—	—	0.225
All Dimensions in mm			

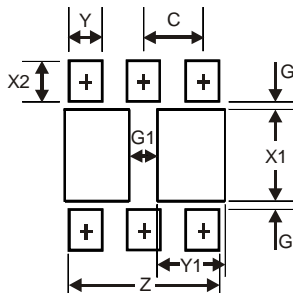
Suggested Pad Layout

Dimensions	Value (in mm)
Z	1.67
G	0.20
G1	0.40
X1	1.0
X2	0.45
Y	0.37
Y1	0.70
C	0.65

IMPORTANT NOTICE

Diodes Incorporated and its subsidiaries reserve the right to make modifications, enhancements, improvements, corrections or other changes without further notice to any product herein. Diodes Incorporated does not assume any liability arising out of the application or use of any product described herein; neither does it convey any license under its patent rights, nor the rights of others. The user of products in such applications shall assume all risks of such use and will agree to hold Diodes Incorporated and all the companies whose products are represented on our website, harmless against all damages.

LIFE SUPPORT

Diodes Incorporated products are not authorized for use as critical components in life support devices or systems without the expressed written approval of the President of Diodes Incorporated.

SBR is a registered trademark of Diodes Incorporated.