

查询"553-0222"供应商

LED CBI® Circuit Board Indicator Bi-level

Dialight

553-XXXX

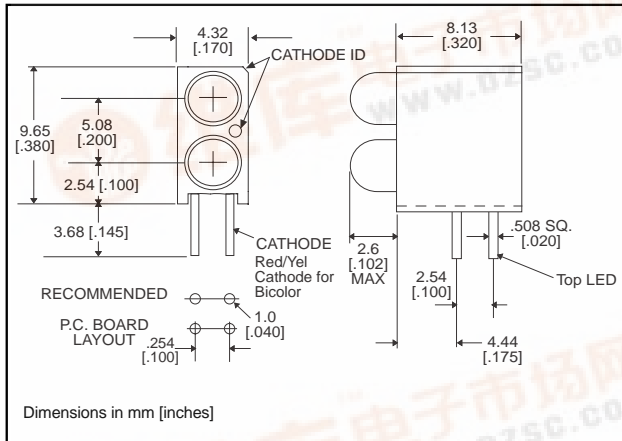

Dimensions in mm [inches]

Standard Polarity shown in drawing: Cathode right

Features

- Multiple CBIs form horizontal LED arrays on 4.45mm (0.175") center-lines. See page 4-41 and 4-42 for pre-assembled arrays
- High Contrast, UL 94 V-0 rated, black housing
- Oxygen index: 32%
- Polymer content: PBT, 0.343 g
- Housing stand-offs facilitate PCB cleaning
- Solderability per MIL-STD-202F, method 208F
- LEDs are safe for direct viewing per IEC 825-1, EN-60825-1

Tolerance note: As noted, otherwise:

- LED Protrusion: ± 0.04 mm [± 0.016]
- CBI Housing: ± 0.02 mm [± 0.008]

Custom Combinations

- Contact factory for information on custom bi-level arrays and color combinations.

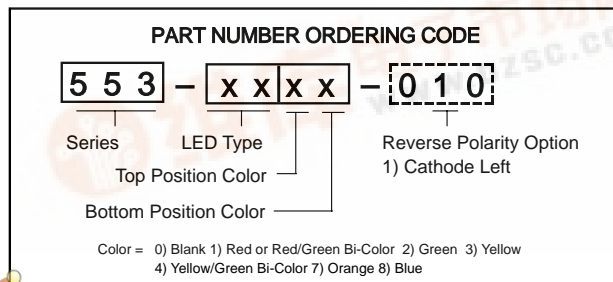

PART NO.

COLOR*

HIGH EFFICIENCY - LED TYPE 01

553-0111	Red
553-0122	Green
553-0133	Yellow
553-0177	Orange
553-0188	Blue ³



LOW CURRENT - LED TYPE 02

553-0211	Red
553-0222	Green
553-0233	Yellow

RESISTOR 5 VOLTS - LED TYPE 03

553-0311	Red
553-0322	Green
553-0333	Yellow

BI-COLOR - LED TYPE 07

553-0711	Red/Green
553-0744	Yellow/Green

NON-DIFFUSED - LED TYPE 22

553-2211	Red
553-2222	Green
553-2233	Yellow

* Top-Bottom LED

To order any of the 553-xxxx part numbers with Reverse Polarity (Cathode Left), please add -010 to the part numbers shown above.



ATTENTION
OBSERVE PRECAUTIONS
FOR HANDLING
ELECTROSTATIC
SENSITIVE
DEVICES

-010 Ordering Code Suffix required ONLY for Reverse Polarity Option

[查询"553-0222"供应商](#)
Typical Operating Characteristics ($T_A=25^{\circ}\text{C}$)

See LED data sheet for additional information
See page 4-70 and 4-71 for Reference Only LED Drive Circuit Examples. See page 4-72 for Pin Out

HIGH EFFICIENCY

Part Number	Color	Peak Wavelength nm	I_V mcd	V_F Volts	Test Current (mA)	Viewing Angle $2\theta_{\%}$	LED Data sheet	Page #
553-0111	Red	650	10	2	10	45°	521-9427	4-64
553-0122	Green	563	16	2.1	10	45°	521-9408	4-64
553-0133	Yellow	585	6.3	2.1	10	45°	521-9428	4-64
553-0177	Orange	600	7	2.2	10	60°	521-9498	4-58
553-0188	Blue	428	12	3.5	10	70°	521-9831	4-57

LOW CURRENT

Part Number	Color	Peak Wavelength nm	I_V mcd	V_F Volts	Test Current (mA)	Viewing Angle $2\theta_{\%}$	LED Data sheet	Page #
553-0211	Red	635	1.6	1.7	2	60°	521-9324	4-60
553-0222	Green	565	1.6	1.9	2	60°	521-9326	4-60
553-0233	Yellow	585	1.6	1.8	2	60°	521-9325	4-60

INTEGRAL RESISTOR, 5 VOLTS

Part Number	Color	Peak Wavelength nm	I_V mcd	Test Voltage	Forward Current (mA)	Viewing Angle $2\theta_{\%}$	LED Data sheet	Page #
553-0311	Red	635	29	5	10	60°	521-9215	4-59
553-0322	Green	565	19	5	10	60°	521-9323	4-59
553-0333	Yellow	585	12.6	5	10	60°	521-9322	4-59

BI-COLOR

Part Number	Color	Peak Wavelength nm	I_V mcd	V_F Volts	Test Current (mA)	Viewing Angle $2\theta_{\%}$	LED Data sheet	Page #
553-0711	Red/Green	635/565	4.7/10	2/2.1	10	50°	521-9459	4-63
553-0744	Yellow/Green	585/565	4.3/6.3	2.1*/2.1*	10	80°	521-9478	4-62

* $I_F = 20\text{mA}$ **NON-DIFFUSED**

Part Number	Color	Peak Wavelength nm	I_V mcd	V_F Volts*	Test Current (mA)	Viewing Angle $2\theta_{\%}$	LED Data sheet	Page #
553-2211	Red	635	29	2	10	45°	521-9432	4-61
553-2222	Green	565	50	2.1	10	45°	521-9430	4-61
553-2233	Yellow	585	20	2.1	10	45°	521-9431	4-61

* $I_F = 20\text{mA}$ **CBI ARRAYS .200 PITCH**

Dialight offers its Multiarray to reduce insertions and to assure indicator alignment. Multiarrays mount indicators on .200 centers. These assemblies are available in arrays of 2 to 6. See pages 4-41 and 4-42 for information. Call factory for information on .185 pitched arrays.





3mm Discrete LED
Tinted, Diffused

Dialight

521-9831



PART NO. 521-9831
COLOR Blue³

MOUNTING CLIP: 515-0006
located on page 4-65



ATTENTION
OBSERVE PRECAUTIONS
FOR HANDLING
ELECTROSTATIC
SENSITIVE
DEVICES

4

ABSOLUTE MAXIMUM RATINGS (T_A=25°C)

Blue
-9831

Power Dissipation (mW)	100
Forward Current (mA)	20
Derating (mA/°C) From 55°C	.44
Operating Temperature (°C)	-40/+100
Storage Temperature (°C)	-40/+100
Soldering Temperature	260°C, 5 seconds, 1.6 mm from case

Solder Adherence per MIL-STD-202E, Method 208C

OPERATING CHARACTERISTICS (T_A=25°C)

Blue
-9831

Luminous Intensity (mcd)	Min.	6.3
I _F =10mA	Typical	12
Peak Wavelength (nm)	Typical	428
λ Peak		
Viewing Angle (2Θ _{1/2})	Typical	70°
Forward Voltage (V)	Typical	3.5
I _F =10mA	Max.	4.2
Reverse Voltage (V) I _R =10μA	Min.	3

Θ_{1/2} is the off axis angle at which the luminous intensity is half the axial luminous intensity

3mm Discrete LED

High Efficiency
Diffused

521-9210, -9211, -9216, -9498, -9636

Dialight

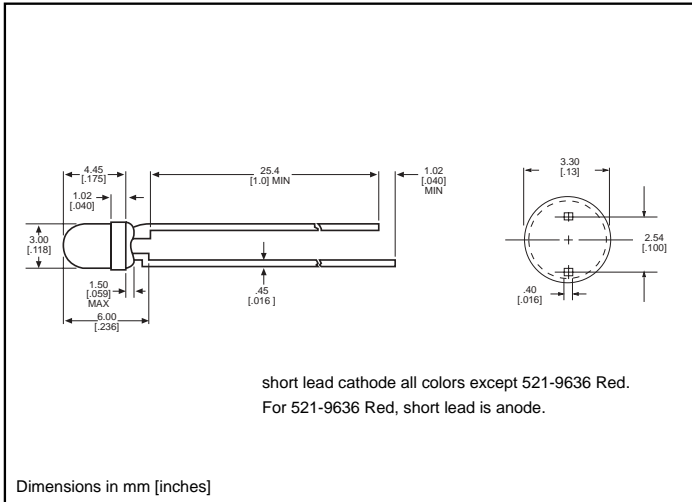

PART NO. COLOR

521-9210 Green
521-9211 Yellow
521-9216 Red
521-9498 Orange
521-9636 Red



MOUNTING CLIP: 515-0006
located on page 4-65

ABSOLUTE MAXIMUM RATINGS ($T_A=25^\circ\text{C}$)	Green -9210	Yellow -9211	Red -9216	Orange -9498	Red -9636
Power Dissipation (mW)	100	60	100	135	100
Forward Current (mA)	30	20	30	25	40
Derating (mA/°C) From 50°C ¹ from 25°C	.4	.25	.4	.5	.5 ¹
Operating Temperature (°C)	-55/+100	-55/+100	-55/+100	-55/+100	-55/+100
Storage Temperature (°C)	-55/+100	-55/+100	-55/+100	-55/+100	-55/+100
Soldering Temperature	260°C, 5 seconds, 1.6 mm from body				

Solder Adherence per MIL-STD-202E, Method 208C

OPERATING CHARACTERISTICS ($T_A=25^\circ\text{C}$)		Green -9210	Yellow -9211	Red -9216	Orange -9498	Red -9636
Luminous Intensity (mcd)	Min.	4.7	7.4	7.4	3.4	8.7 ¹
	Typical	12.6	10	10	7	48 ¹
Peak Wavelength (nm)	Typical	565	585	635	600	660
Viewing Angle (2θ °)	Typical	60°	60°	60°	60°	60°
Forward Voltage (V)	Typical	2.1 ¹	2.1 ¹	2 ¹	2.2	1.8 ¹
	Max.	2.8 ¹	2.8 ¹	2.8 ¹	3	2.4 ¹
Reverse Voltage (V), $I_R=100\mu\text{A}$	Max.	5	5	5	5	4

¹ θ is the off axis angle at which the luminous intensity is half the axial luminous intensity

查#558-022*供應商

3mm Discrete LED
Integral Resistor, 5V
Diffused

Dialight

521-9215, -9322, -9323

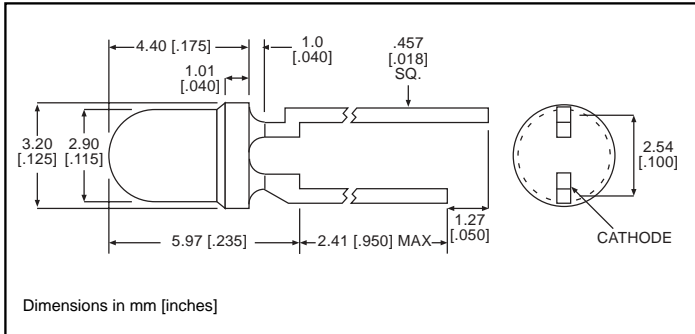

PART NO.	COLOR
521-9215	Red
521-9322	Yellow
521-9323	Green

MOUNTING CLIP: 515-0006
 located on page 4-65

ABSOLUTE MAXIMUM RATINGS ($T_A=25^\circ\text{C}$)

	Red -9215	Yellow -9322	Green -9323
Forward Voltage (V)	7.5	7.5	7.5
Derating ($V/^\circ\text{C}$) From 50°C	.086	.086	.071
Operating Temperature ($^\circ\text{C}$)	-40/+85	-40/+85	-20/+85
Storage Temperature ($^\circ\text{C}$)	-55/+100	-55/+100	-55/+100
Soldering Temperature	260 $^\circ\text{C}$, 5 seconds, 1.6 mm from case		

Solder Adherence per MIL-STD-202E, Method 208C

OPERATING CHARACTERISTICS ($T_A=25^\circ\text{C}$)

		Red -9215	Yellow -9322	Green -9323
Luminous Intensity (mcd)	Min.	8.7	3.7	5.6
	Typical	29	12.6	19
Peak Wavelength (nm)	Typical	635	585	565
Viewing Angle ($2\theta_{1/2}$)	Typical	60 $^\circ$	60 $^\circ$	60 $^\circ$
Forward Current (mA)	Typical	10	10	10
	Max.	20	20	20
Reverse Voltage (V), $I_R=100\mu\text{A}$	Min.	5	5	5

$\theta_{1/2}$ is the off axis angle at which the luminous intensity is half the axial luminous intensity

4

3mm Discrete LED

Low Current
Diffused

Dialight

521-9324, -9325, -9326

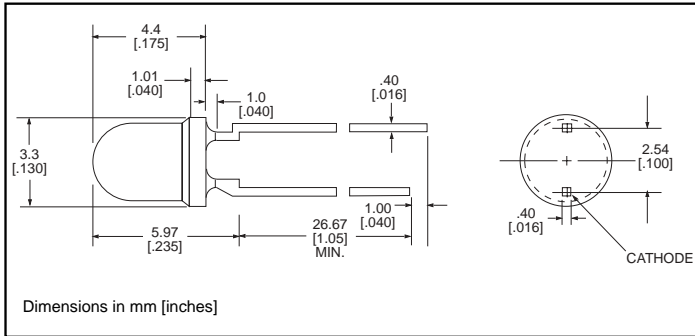

PART NO.	COLOR
521-9324	Red
521-9325	Yellow
521-9326	Green

MOUNTING CLIP: 515-0006
located on page 4-65

ABSOLUTE MAXIMUM RATINGS (T_A=25°C)

	Red -9324	Yellow -9325	Green -9326
Power Dissipation (mW)	20	20	20
Forward Current (mA)	7	7	7
Derating (mA/°C) From 90°C	.7	.7	.7
Peak Current (mA) Pulse width = 10 μs	500	500	500
Operating Temperature (°C)	-55/+100	-55/+100	-55/+100
Storage Temperature (°C)	-55/+100	-55/+100	-55/+100
Soldering Temperature	260°C, 5 seconds, 1.6 mm from case		

Solder Adherence per MIL-STD-202E, Method 208C

OPERATING CHARACTERISTICS (T_A=25°C)

		Red -9324	Yellow -9325	Green -9326
Luminous Intensity (mcd) I _F =2mA	Min.	1	1	1
	Typical	1.6	1.6	1.6
Peak Wavelength (nm) λ _{Peak}	Typical	635	585	565
Viewing Angle (2Θ ^{1/2})	Typical	60°	60°	60°
Forward Voltage (V) I _F =2mA	Typical	1.7	1.8	1.9
	Max.	2.2	2.7	2.2
Reverse Voltage (V), I _R =50μA	Min.	5	5	5

Θ^{1/2} is the off axis angle at which the luminous intensity is half the axial luminous intensity

查询"553-0232"供应商

3mm Discrete LED
High Efficiency
Tinted, Non-Diffused



521-9430, -9431, -9432

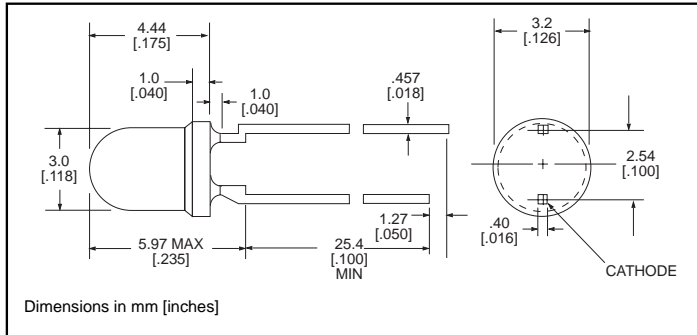

PART NO.	COLOR
521-9430	Green
521-9431	Yellow
521-9432	Red

MOUNTING CLIP: 515-0006
 located on page 4-65

ABSOLUTE MAXIMUM RATINGS ($T_A=25^\circ\text{C}$)

	Green -9430	Yellow -9431	Red -9432
Power Dissipation (mW)	100	60	100
Forward Current (mA)	30	20	30
Derating (mA/°C) From 50°C	.4	.25	.4
Peak Current (mA) Pulse width = 100µs	120	80	120
Operating Temperature (°C)	-55/+100	-55/+100	-55/+100
Storage Temperature (°C)	-55/+100	-55/+100	-55/+100
Soldering Temperature	260°C, 5 seconds, 1.6 mm from case		

Solder Adherence per MIL-STD-202E, Method 208C

OPERATING CHARACTERISTICS ($T_A=25^\circ\text{C}$)

		Green -9430	Yellow -9431	Red -9432
Luminous Intensity (mcd) $I_F=10\text{mA}$	Min.	32	10	8.7
	Typical	50	20	29
Peak Wavelength (nm) λ_{Peak}	Typical	565	585	635
Viewing Angle ($2\theta_{1/2}$)	Typical	45°	45°	45°
Forward Voltage (V) $I_F=20\text{mA}$	Typical	2.1	2.1	2
	Max.	2.8	2.8	2.8

$\theta_{1/2}$ is the off axis angle at which the luminous intensity is half the axial luminous intensity

4

3mm Discrete LED

Bi-Color
Non-Tinted, Diffused



521-9478, -9628, -9768

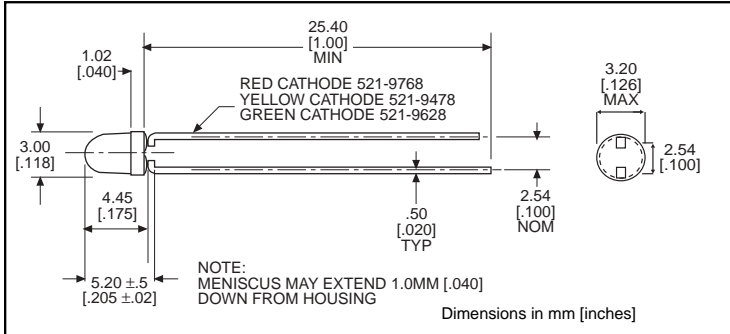

PART NO.	COLOR
521-9478	Yellow/Green
521-9628	Red/Green
521-9768	Red/Yellow

MOUNTING CLIP: 515-0006
located on page 4-65

ABSOLUTE MAXIMUM RATINGS (T _A =25°C)	Yellow/Green	Red/Green	Red/Yellow
	-9478	-9628	-9768
Power Dissipation (mW)	60/100	140/100	100/60
Forward Current (mA)	20/30	40/30	30/20
Derating (mA/°C) From 25°C 1 From 50°C	.25 ¹ /.40 ¹	.5/.4	.4 ¹ /.25 ¹
Peak Current (mA) Pulse width = 10µs	80/120	200/120	120/80
Operating Temperature (°C)	-55/+100	-55/+100	-55/+100
Storage Temperature (°C)	-55/+100	-55/+100	-55/+100
Soldering Temperature	260°C, 5 seconds, 1.66 mm from case		

Solder Adherence per MIL-STD-202E, Method 208C

OPERATING CHARACTERISTICS (T _A =25°C)		Yellow/Green	Red/Green	Red/Yellow
		-9478	-9628	-9768
Luminous Intensity (mcd)	Min.	2.5/2.5	3.7*/1.1*	1.7*/1.7*
	Typical	4.3/6.3	12.6*/3.7*	5.6*/5.6*
Peak Wavelength (nm)	Typical	585/565	660/565	630/585
Viewing Angle (2θ ½)	Typical	80°	200°	80°
Forward Voltage (V)	Typical	2.1/2.1	1.8/2.1	2/2.1
	Max.	2.8/2.8	2.4/2.8	2.8/2.8
Reverse Voltage (V) I _R =100ua	Min.	5	5	5

θ ½ is the off axis angle at which the luminous intensity is half the axial luminous intensity

查询: 1551-0272 供应商

3mm Discrete LED
Bi-Color
Non-Tinted, Diffused



521-9459

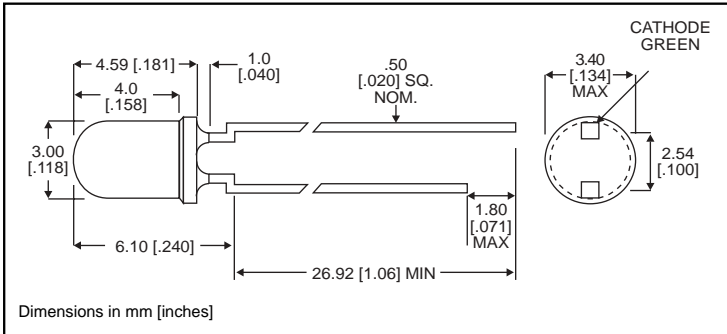

PART NO. 521-9459
COLOR Red/Green

MOUNTING CLIP: 515-0006
 located on page 4-65

4

ABSOLUTE MAXIMUM RATINGS ($T_A=25^\circ\text{C}$)

Red/Green
-9459

Power Dissipation (mW)	140
Forward Current (mA)	45
Derating (mA/°C) From 25°C	.6
Peak Current (mA)	1000
<i>Pulse width = 10µs</i>	
Operating Temperature (°C)	-55/+100
Storage Temperature (°C)	-55/+100
Soldering Temperature	260°C, 5 seconds, 1.6 mm from case

Solder Adherence per MIL-STD-202E, Method 208C

OPERATING CHARACTERISTICS ($T_A=25^\circ\text{C}$)

Red/Green
-9459

Luminous Intensity (mcd)	Min.	2.5/3.7
$I_F=10\text{mA}$	Typical	4.7/10
Peak Wavelength (nm)	Typical	635/565
λ Peak		
Viewing Angle ($2\theta_{1/2}$)	Typical	50°
Forward Voltage (V)	Typical	2/2.1
$I_F=10\text{mA}$	Max.	2.8/2.8

$\theta_{1/2}$ is the off axis angle at which the luminous intensity is half the axial luminous intensity

3mm Discrete LED
High Efficiency
Diffused

Dialight

521-94xx



TYPE
521-9408
521-9427
521-9428

COLOR
Green
Red
Yellow

MOUNTING CLIP: 515-0006
located on page 4-65

ABSOLUTE MAXIMUM RATINGS ($T_A=25^\circ\text{C}$)

	Green -9408	Red -9427	Yellow -9428
Power Dissipation (mW)	75	60	60
Forward Current (mA)	25	20	20
Derating (mA/°C) <i>From 50°C</i>	.5	.5	.5
Peak Current (mA)	60	60	60
Operating Temperature (°C)	-25/+85	-25/+85	-25/+85
Storage Temperature (°C)	-30/+100	-30/+100	-30/+100
Soldering Temperature	260°C, 5 seconds, 1.6 mm from case		

Solder Adherence per MIL-STD-202E, Method 208C

OPERATING CHARACTERISTICS ($T_A=25^\circ\text{C}$)

		Green -9408	Red -9427	Yellow -9428
Luminous Intensity (mcd)	Min.	5.6	3.6	2.2
	Typical	16	10	6.3
Peak Wavelength (nm)	Typical	563	650	585
Viewing Angle ($2\theta^{1/2}$)	Typical	45°	45°	45°
Forward Voltage (V)	Typical	2.1	2	2.1
	Max.	3	3	3
Reverse Voltage (V), $I_R=10\mu\text{A}$	Min.	3	3	3

$\theta^{1/2}$ is the off axis angle at which the luminous intensity is half the axial luminous intensity