

July 1999

## LM34 Precision Fahrenheit Temperature Sensors

### General Description

The LM34 series are precision integrated-circuit temperature sensors, whose output voltage is linearly proportional to the Fahrenheit temperature. The LM34 thus has an advantage over linear temperature sensors calibrated in degrees Kelvin, as the user is not required to subtract a large constant voltage from its output to obtain convenient Fahrenheit scaling. The LM34 does not require any external calibration or trimming to provide typical accuracies of  $\pm 1/2^\circ\text{F}$  at room temperature and  $\pm 1 1/2^\circ\text{F}$  over a full  $-50$  to  $+300^\circ\text{F}$  temperature range. Low cost is assured by trimming and calibration at the wafer level. The LM34's low output impedance, linear output, and precise inherent calibration make interfacing to readout or control circuitry especially easy. It can be used with single power supplies or with plus and minus supplies. As it draws only  $75\ \mu\text{A}$  from its supply, it has very low self-heating, less than  $0.2^\circ\text{F}$  in still air. The LM34 is rated to operate over a  $-50^\circ$  to  $+300^\circ\text{F}$  temperature range, while the LM34C is rated for a  $-40^\circ$  to  $+230^\circ\text{F}$  range ( $0^\circ\text{F}$  with improved accuracy). The LM34 series is available packaged in

hermetic TO-46 transistor packages, while the LM34C, LM34CA and LM34D are also available in the plastic TO-92 transistor package. The LM34D is also available in an 8-lead surface mount small outline package. The LM34 is a complement to the LM35 (Centigrade) temperature sensor.

### Features

- Calibrated directly in degrees Fahrenheit
- Linear  $+10.0\ \text{mV}/^\circ\text{F}$  scale factor
- $1.0^\circ\text{F}$  accuracy guaranteed (at  $+77^\circ\text{F}$ )
- Rated for full  $-50^\circ$  to  $+300^\circ\text{F}$  range
- Suitable for remote applications
- Low cost due to wafer-level trimming
- Operates from 5 to 30 volts
- Less than  $90\ \mu\text{A}$  current drain
- Low self-heating,  $0.18^\circ\text{F}$  in still air
- Nonlinearity only  $\pm 0.5^\circ\text{F}$  typical
- Low-impedance output,  $0.4\ \Omega$  for 1 mA load

### Connection Diagrams

**TO-46  
Metal Can Package  
(Note 1)**

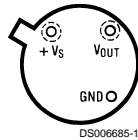

DS006685-1

**Order Numbers LM34H,  
LM34AH, LM34CH,  
LM34CAH or LM34DH  
See NS Package  
Number H03H**

**TO-92  
Plastic Package**

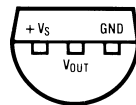

BOTTOM VIEW  
DS006685-2

**Order Number LM34CZ,  
LM34CAZ or LM34DZ  
See NS Package  
Number Z03A**

**SO-8  
Small Outline  
Molded Package**

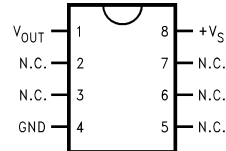

DS006685-20

N.C. = No Connection

**Top View  
Order Number LM34DM  
See NS Package Number M08A**

**Note 1:** Case is connected to negative pin (GND).

TRI-STATE® is a registered trademark of National Semiconductor Corporation.

## Typical Applications

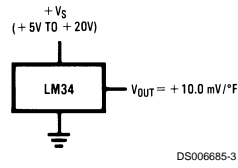

**FIGURE 1. Basic Fahrenheit Temperature Sensor (+5° to +300°F)**

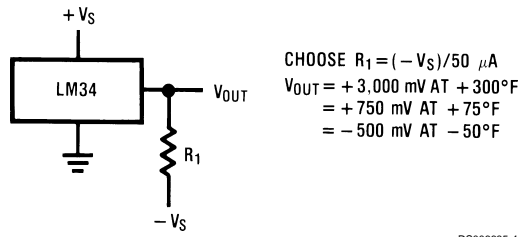

**FIGURE 2. Full-Range Fahrenheit Temperature Sensor**

**Absolute Maximum Ratings** (Note 11)

If Military/Aerospace specified devices are required, please contact the National Semiconductor Sales Office/ Distributors for availability and specifications.

Supply Voltage	+35V to -0.2V
Output Voltage	+6V to -1.0V
Output Current	10 mA
Storage Temperature,	
TO-46 Package	-76°F to +356°F
TO-92 Package	-76°F to +300°F
SO-8 Package	-65°C to +150°C
ESD Susceptibility (Note 12)	800V
Lead Temp.	

TO-46 Package	
(Soldering, 10 seconds)	+300°C
TO-92 Package	
(Soldering, 10 seconds)	+260°C
SO Package (Note 13)	
Vapor Phase (60 seconds)	215°C
Infrared (15 seconds)	220°C
Specified Operating Temp. Range (Note 3)	
	<b>T<sub>MIN</sub> to T<sub>MAX</sub></b>
LM34, LM34A	-50°F to +300°F
LM34C, LM34CA	-40°F to +230°F
LM34D	+32°F to +212°F

**DC Electrical Characteristics** (Notes 2, 7)

Parameter	Conditions	LM34A			LM34CA			Units (Max)
		Typical	Tested Limit (Note 5)	Design Limit (Note 6)	Typical	Tested Limit (Note 5)	Design Limit (Note 6)	
Accuracy (Note 8)	T <sub>A</sub> = +77°F	±0.4	±1.0		±0.4	±1.0		°F
	T <sub>A</sub> = 0°F	±0.6			±0.6		±2.0	°F
	T <sub>A</sub> = T <sub>MAX</sub>	±0.8	±2.0		±0.8	±2.0		°F
	T <sub>A</sub> = T <sub>MIN</sub>	±0.8	±2.0		±0.8		±3.0	°F
Nonlinearity (Note 9)	T <sub>MIN</sub> ≤ T <sub>A</sub> ≤ T <sub>MAX</sub>	<b>±0.35</b>		<b>±0.7</b>	<b>±0.30</b>		<b>±0.6</b>	°F
Sensor Gain (Average Slope)	T <sub>MIN</sub> ≤ T <sub>A</sub> ≤ T <sub>MAX</sub>	<b>+10.0</b>		<b>+9.9</b>	<b>+10.0</b>		<b>+9.9</b>	mV/°F, min
			<b>+10.1</b>				<b>+10.1</b>	mV/°F, max
Load Regulation (Note 4)	T <sub>A</sub> = +77°F	±0.4	±1.0		±0.4	±1.0		mV/mA
	T <sub>MIN</sub> ≤ T <sub>A</sub> ≤ T <sub>MAX</sub> 0 ≤ I <sub>L</sub> ≤ 1 mA	<b>±0.5</b>		<b>±3.0</b>	<b>±0.5</b>		<b>±3.0</b>	mV/mA
Line Regulation (Note 4)	T <sub>A</sub> = +77°F	±0.01	±0.05		±0.01	±0.05		mV/V
	5V ≤ V <sub>S</sub> ≤ 30V	<b>±0.02</b>		<b>±0.1</b>	<b>±0.02</b>		<b>±0.1</b>	mV/V
Quiescent Current (Note 10)	V <sub>S</sub> = +5V, +77°F	75	90		75	90		µA
	V <sub>S</sub> = +5V	<b>131</b>		<b>160</b>	<b>116</b>		<b>139</b>	µA
	V <sub>S</sub> = +30V, +77°F	76	92		76	92		µA
	V <sub>S</sub> = +30V	<b>132</b>		<b>163</b>	<b>117</b>		<b>142</b>	µA
Change of Quiescent Current (Note 4)	4V ≤ V <sub>S</sub> ≤ 30V, +77°F	+0.5	2.0		0.5	2.0		µA
	5V ≤ V <sub>S</sub> ≤ 30V	<b>+1.0</b>		<b>3.0</b>	<b>1.0</b>		<b>3.0</b>	µA
Temperature Coefficient of Quiescent Current		<b>+0.30</b>		<b>+0.5</b>	<b>+0.30</b>		<b>+0.5</b>	µA/°F
Minimum Temperature for Rated Accuracy	In circuit of Figure 1, I <sub>L</sub> = 0	+3.0		+5.0	+3.0		+5.0	°F
Long-Term Stability	T <sub>J</sub> = T <sub>MAX</sub> for 1000 hours	±0.16			±0.16			°F

**Note 2:** Unless otherwise noted, these specifications apply: -50°F ≤ T<sub>J</sub> ≤ +300°F for the LM34 and LM34A; -40°F ≤ T<sub>J</sub> ≤ +230°F for the LM34C and LM34CA; and +32°F ≤ T<sub>J</sub> ≤ +212°F for the LM34D. V<sub>S</sub> = +5 Vdc and I<sub>LOAD</sub> = 50 µA in the circuit of Figure 2; +6 Vdc for LM34 and LM34A for 230°F ≤ T<sub>J</sub> ≤ 300°F. These specifications also apply from +5°F to T<sub>MAX</sub> in the circuit of Figure 1.

**Note 3:** Thermal resistance of the TO-46 package is 720°F/W junction to ambient and 43°F/W junction to case. Thermal resistance of the TO-92 package is 324°F/W junction to ambient. Thermal resistance of the small outline molded package is 400°F/W junction to ambient. For additional thermal resistance information see table in the Typical Applications section.

**Note 4:** Regulation is measured at constant junction temperature using pulse testing with a low duty cycle. Changes in output due to heating effects can be computed by multiplying the internal dissipation by the thermal resistance.

**Note 5:** Tested limits are guaranteed and 100% tested in production.

**Note 6:** Design limits are guaranteed (but not 100% production tested) over the indicated temperature and supply voltage ranges. These limits are not used to calculate outgoing quality levels.

**Note 7:** Specification in **BOLDFACE TYPE** apply over the full rated temperature range.

### DC Electrical Characteristics (Notes 2, 7) (Continued)

**Note 8:** Accuracy is defined as the error between the output voltage and 10 mV/°F times the device's case temperature at specified conditions of voltage, current, and temperature (expressed in °F).

**Note 9:** Nonlinearity is defined as the deviation of the output-voltage-versus-temperature curve from the best-fit straight line over the device's rated temperature range.

**Note 10:** Quiescent current is defined in the circuit of *Figure 1*.

**Note 11:** Absolute Maximum Ratings indicate limits beyond which damage to the device may occur. DC and AC electrical specifications do not apply when operating the device beyond its rated operating conditions (Note 2).

**Note 12:** Human body model, 100 pF discharged through a 1.5 kΩ resistor.

**Note 13:** See AN-450 "Surface Mounting Methods and Their Effect on Product Reliability" or the section titled "Surface Mount" found in a current National Semiconductor Linear Data Book for other methods of soldering surface mount devices.

### DC Electrical Characteristics (Notes 2, 7)

Parameter	Conditions	LM34			LM34C, LM34D			Units (Max)
		Typical	Tested Limit (Note 5)	Design Limit (Note 6)	Typical	Tested Limit (Note 5)	Design Limit (Note 6)	
Accuracy, LM34, LM34C (Note 8)	$T_A = +77^\circ\text{F}$	±0.8	±2.0		±0.8	±2.0		°F
	$T_A = 0^\circ\text{F}$	±1.0			±1.0		±3.0	°F
	$T_A = T_{\text{MAX}}$	±1.6	±3.0		±1.6		±3.0	°F
	$T_A = T_{\text{MIN}}$	±1.6		±3.0	±1.6		±4.0	°F
Accuracy, LM34D (Note 8)	$T_A = +77^\circ\text{F}$				±1.2	±3.0		°F
	$T_A = T_{\text{MAX}}$				±1.8		±4.0	°F
	$T_A = T_{\text{MIN}}$				±1.8		±4.0	°F
Nonlinearity (Note 9)	$T_{\text{MIN}} \leq T_A \leq T_{\text{MAX}}$	±0.6		±1.0	±0.4		±1.0	°F
Sensor Gain (Average Slope)	$T_{\text{MIN}} \leq T_A \leq T_{\text{MAX}}$	+10.0	+9.8, +10.2		+10.0		+9.8, +10.2	mV/°F, min mV/°F, max
Load Regulation (Note 4)	$T_A = +77^\circ\text{F}$	±0.4	±2.5		±0.4	±2.5		mV/mA
	$T_{\text{MIN}} \leq T_A \leq +150^\circ\text{F}$ $0 \leq I_L \leq 1 \text{ mA}$	±0.5		±6.0	±0.5		±6.0	mV/mA
Line Regulation (Note 4)	$T_A = +77^\circ\text{F}$	±0.01	±0.1		±0.01	±0.1		mV/V
	$5\text{V} \leq V_S \leq 30\text{V}$	±0.02		±0.2	±0.02		±0.2	mV/V
Quiescent Current (Note 10)	$V_S = +5\text{V}, +77^\circ\text{F}$	75	100		75	100		μA
	$V_S = +5\text{V}$	131		176	116		154	μA
	$V_S = +30\text{V}, +77^\circ\text{F}$	76	103		76	103		μA
	$V_S = +30\text{V}$	132		181	117		159	μA
Change of Quiescent Current (Note 4)	$4\text{V} \leq V_S \leq 30\text{V}, +77^\circ\text{F}$	+0.5	3.0		0.5	3.0		μA
	$5\text{V} \leq V_S \leq 30\text{V}$	+1.0		5.0	1.0		5.0	μA
Temperature Coefficient of Quiescent Current		+0.30		+0.7	+0.30		+0.7	μA/°F
Minimum Temperature for Rated Accuracy	In circuit of <i>Figure 1</i> , $I_L = 0$	+3.0		+5.0	+3.0		+5.0	°F
Long-Term Stability	$T_j = T_{\text{MAX}}$ for 1000 hours	±0.16			±0.16			°F

## Typical Performance Characteristics

**Thermal Resistance Junction to Air**

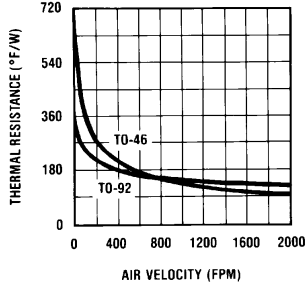

DS006685-22

**Thermal Time Constant**

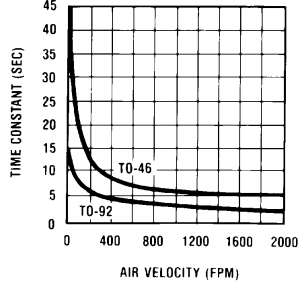

DS006685-23

**Thermal Response in Still Air**

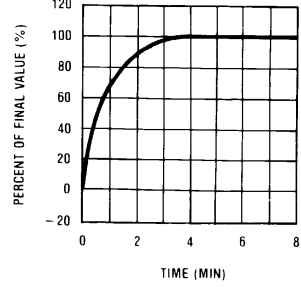

DS006685-24

**Thermal Response in Stirred Oil Bath**

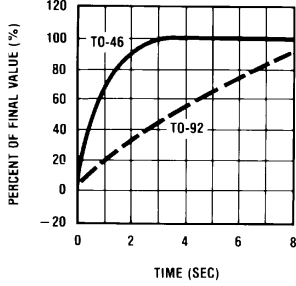

DS006685-25

**Minimum Supply Voltage vs. Temperature**

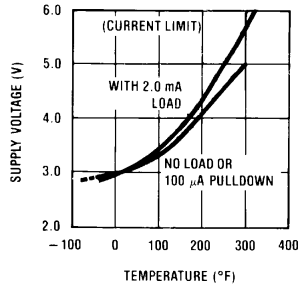

DS006685-26

**Quiescent Current vs. Temperature (In Circuit of Figure 1)**

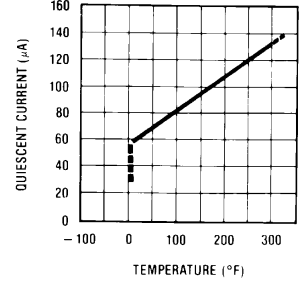

DS006685-27

**Quiescent Current vs. Temperature (In Circuit of Figure 2;  $-V_s = -5V$ ,  $R1 = 100k$ )**

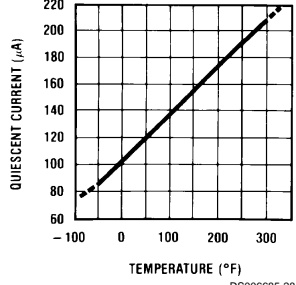

DS006685-28

**Accuracy vs. Temperature (Guaranteed)**

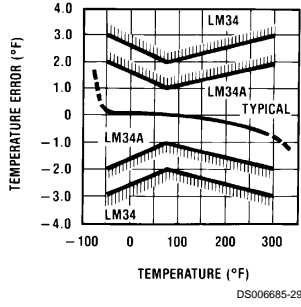

DS006685-29

**Accuracy vs. Temperature (Guaranteed)**

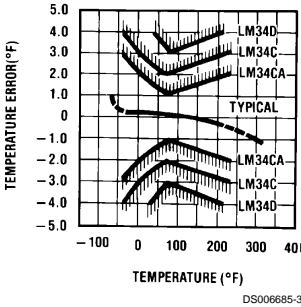

DS006685-30

## Typical Performance Characteristics (Continued)

Noise Voltage

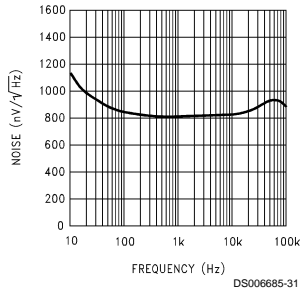

Start-Up Response

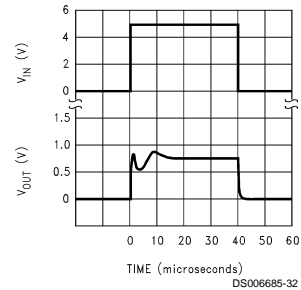

## Typical Applications

The LM34 can be applied easily in the same way as other integrated-circuit temperature sensors. It can be glued or cemented to a surface and its temperature will be within about 0.02° F of the surface temperature. This presumes that the ambient air temperature is almost the same as the surface temperature; if the air temperature were much higher or lower than the surface temperature, the actual temperature of the LM34 die would be at an intermediate temperature between the surface temperature and the air temperature. This is especially true for the TO-92 plastic package, where the copper leads are the principal thermal path to carry heat into the device, so its temperature might be closer to the air temperature than to the surface temperature.

To minimize this problem, be sure that the wiring to the LM34, as it leaves the device, is held at the same temperature as the surface of interest. The easiest way to do this is to cover up these wires with a bead of epoxy which will insure that the leads and wires are all at the same temperature as the surface, and that the LM34 die's temperature will not be affected by the air temperature.

The TO-46 metal package can also be soldered to a metal surface or pipe without damage. Of course in that case, the V<sub>-</sub> terminal of the circuit will be grounded to that metal. Alternatively, the LM34 can be mounted inside a sealed-end metal tube, and can then be dipped into a bath or screwed into a threaded hole in a tank. As with any IC, the LM34 and accompanying wiring and circuits must be kept insulated and dry, to avoid leakage and corrosion. This is especially true if the circuit may operate at cold temperatures where condensation can occur. Printed-circuit coatings and varnishes such as Humiseal and epoxy paints or dips are often used to insure that moisture cannot corrode the LM34 or its connections.

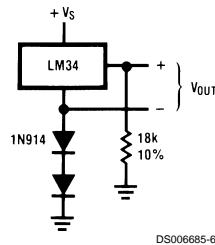

These devices are sometimes soldered to a small, light-weight heat fin to decrease the thermal time constant

and speed up the response in slowly-moving air. On the other hand, a small thermal mass may be added to the sensor to give the steadiest reading despite small deviations in the air temperature.

## Capacitive Loads

Like most micropower circuits, the LM34 has a limited ability to drive heavy capacitive loads. The LM34 by itself is able to drive 50 pF without special precautions. If heavier loads are anticipated, it is easy to isolate or decouple the load with a resistor; see Figure 3. Or you can improve the tolerance of capacitance with a series R-C damper from output to ground; see Figure 4. When the LM34 is applied with a 499Ω load resistor (as shown), it is relatively immune to wiring capacitance because the capacitance forms a bypass from ground to input, not on the output. However, as with any linear circuit connected to wires in a hostile environment, its performance can be affected adversely by intense electromagnetic sources such as relays, radio transmitters, motors with arcing brushes, SCR's transients, etc., as its wiring can act as a receiving antenna and its internal junctions can act as rectifiers. For best results in such cases, a bypass capacitor from V<sub>IN</sub> to ground and a series R-C damper such as 75Ω in series with 0.2 or 1 μF from output to ground are often useful. These are shown in the following circuits.

### Typical Applications

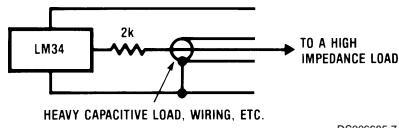

FIGURE 3. LM34 with Decoupling from Capacitive Load

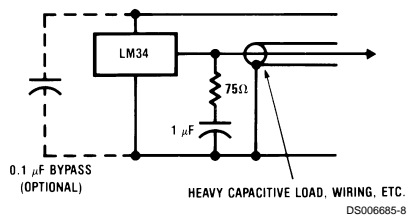

FIGURE 4. LM34 with R-C Damper

#### Temperature Rise of LM34 Due to Self-Heating (Thermal Resistance)

Conditions	TO-46,	TO-46,	TO-92,	TO-92,	SO-8	SO-8
	No Heat Sink	Small Heat Fin (Note 14)	No Heat Sink	Small Heat Fin (Note 15)	No Heat Sink	Small Heat Fin (Note 15)
Still air	720°F/W	180°F/W	324°F/W	252°F/W	400°F/W	200°F/W
Moving air	180°F/W	72°F/W	162°F/W	126°F/W	190°F/W	160°F/W
Still oil	180°F/W	72°F/W	162°F/W	126°F/W		
Stirred oil (Clamped to metal, infinite heat sink)	90°F/W	54°F/W (43°F/W)	81°F/W	72°F/W		(95°F/W)

Note 14: Wakefield type 201 or 1" disc of 0.020" sheet brass, soldered to case, or similar.

Note 15: TO-92 and SO-8 packages glued and leads soldered to 1" square of 1/16" printed circuit board with 2 oz copper foil, or similar.

#### Two-Wire Remote Temperature Sensor (Grounded Sensor)

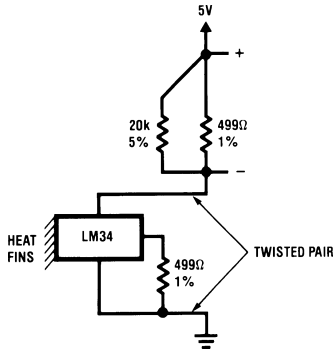

$V_{OUT} = 10\text{mV}/^{\circ}\text{F} (T_A + 3^{\circ}\text{F})$   
FROM  $+3^{\circ}\text{F}$  TO  $+100^{\circ}\text{F}$

DS006685-9

#### Two-Wire Remote Temperature Sensor (Output Referred to Ground)

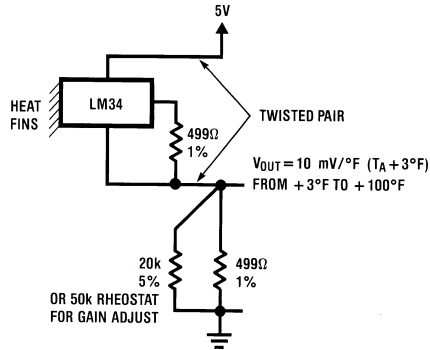

$V_{OUT} = 10\text{mV}/^{\circ}\text{F} (T_A + 3^{\circ}\text{F})$   
FROM  $+3^{\circ}\text{F}$  TO  $+100^{\circ}\text{F}$

DS006685-10









**Physical Dimensions** inches (millimeters) unless otherwise noted

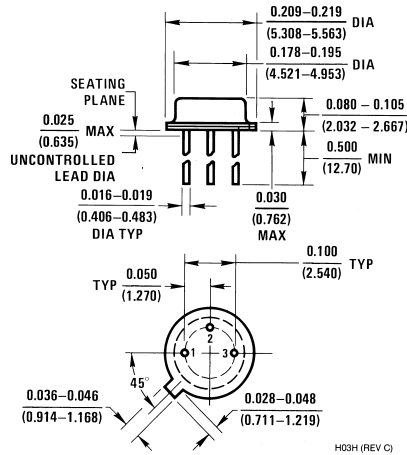

Order Number LM34H, LM34AH, LM34CH,  
LM34CAH or LM34DH  
NS Package H03H

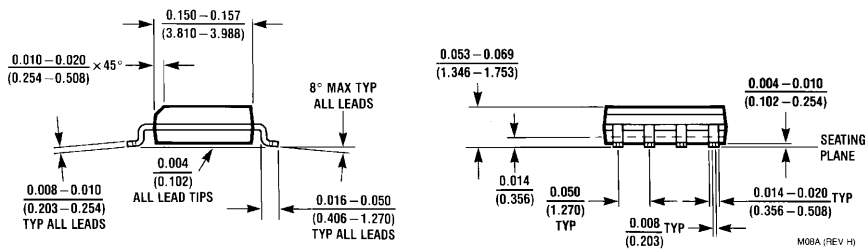
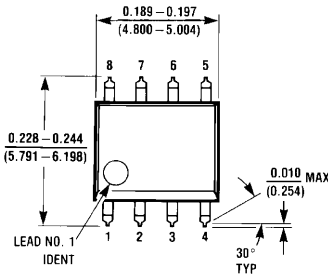

Order Number LM34DM  
NS Package Number M08A

**Physical Dimensions** inches (millimeters) unless otherwise noted (Continued)

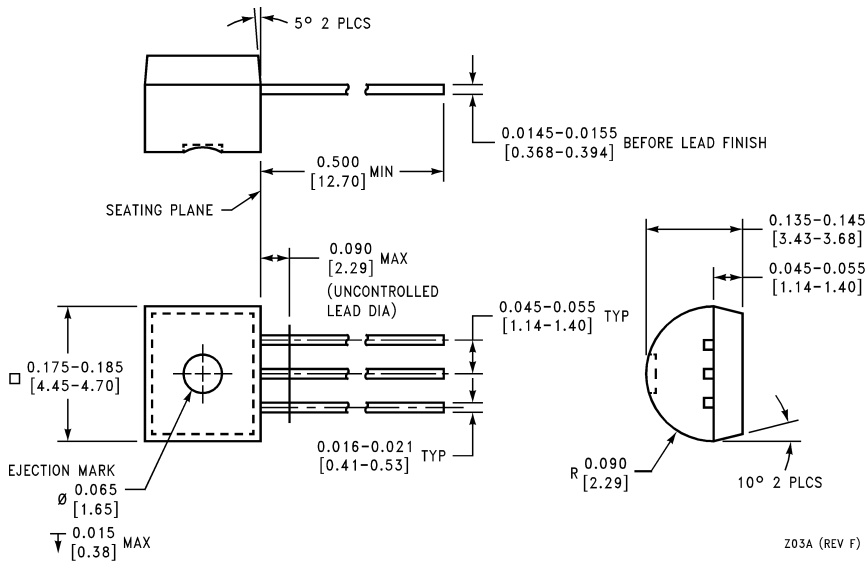

Order Number LM34CZ, LM34CAZ or LM34DZ  
NS Package Z03A

Z03A (REV F)

**LIFE SUPPORT POLICY**

NATIONAL'S PRODUCTS ARE NOT AUTHORIZED FOR USE AS CRITICAL COMPONENTS IN LIFE SUPPORT DEVICES OR SYSTEMS WITHOUT THE EXPRESS WRITTEN APPROVAL OF THE PRESIDENT AND GENERAL COUNSEL OF NATIONAL SEMICONDUCTOR CORPORATION. As used herein:

1. Life support devices or systems are devices or systems which, (a) are intended for surgical implant into the body, or (b) support or sustain life, and whose failure to perform when properly used in accordance with instructions for use provided in the labeling, can be reasonably expected to result in a significant injury to the user.
2. A critical component is any component of a life support device or system whose failure to perform can be reasonably expected to cause the failure of the life support device or system, or to affect its safety or effectiveness.



**National Semiconductor Corporation**  
Americas  
Tel: 1-800-272-9959  
Fax: 1-800-737-7018  
Email: support@nsc.com

www.national.com

**National Semiconductor Europe**

Fax: +49 (0) 1 80-530 85 86  
Email: europe.support@nsc.com  
Deutsch Tel: +49 (0) 1 80-530 85 85  
English Tel: +49 (0) 1 80-532 78 32  
Français Tel: +49 (0) 1 80-532 93 58  
Italiano Tel: +49 (0) 1 80-534 16 80

**National Semiconductor Asia Pacific Customer Response Group**

Tel: 65-2544466  
Fax: 65-2504466  
Email: sea.support@nsc.com

**National Semiconductor Japan Ltd.**

Tel: 81-3-5639-7560  
Fax: 81-3-5639-7507