

High Speed Optocoupler, 10 MBd SOIC-8 Package

Features

- Choice of CMR performance of 10 kV/μs, 5 kV/μs, and 100 v/μs
- External creepage distance > 5 mm
- High speed: 10 MBd typical
- + 5 V CMOS compatibility
- Guaranteed AC and DC performance over temperature: - 40 to + 100 °C Temp. Range
- Pure tin leads
- Meets IEC60068-2-42 (SO₂) and IEC60068-2-43 (H₂S) requirements
- Low input current capability: 5 mA
- Lead (Pb)-free component
- Component in accordance to RoHS 2002/95/EC and WEEE 2002/96/EC



RoHS COMPLIANT



20050

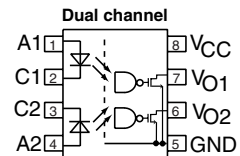
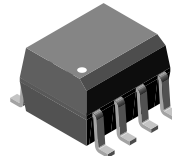

SFH6755T/56T/57T

18921-7

Agency Approvals

- UL1577, File No. E52744 System Code Y
- CUL - File No. E52744, equivalent to CSA bulletin 5A
- DIN EN 60747-5-2 (VDE0884)
- Reinforced insulation rating
- VDE available with Option 1 per IEC60950 2.10.5.1

Applications

- Microprocessor System Interface
- PLC, ATE input/output isolation
- Computer peripheral interface
- Digital Fieldbus Isolation: CC-Link, DeviceNet, Profibus, SDS
- High speed A/D and D/A conversion
- AC Plasma Display Panel Level Shifting
- Multiplexed Data Transmission
- Digital control power supply
- Ground loop elimination

Description

The SFH675xT-series, is a dual channel 10 MBd optocoupler utilizing a high efficient input LED coupled with an integrated optical photodiode IC detector. The detector has an open drain NMOS-transistor output, providing less leakage compared to an open collector Schottky clamped transistor output. The internal shield provides a guaranteed common mode transient immunity of 5 kV/μs for the SFH6756T and 10 kV/μs for the SFH6757T. The use of a 0.1 μF bypass capacitor connected between pin 5 and 8 is recommended.

Order Information

Part	Remarks
SFH6755T	100 V/μs, Dual channel, SOIC-8
SFH6756T	5 kV/μs, Dual channel, SOIC-8
SFH6757T	10 kV/μs, Dual channel, SOIC-8

Truth Table (Positive Logic)

LED	ENABLE	OUTPUT
ON	H	L
OFF	H	H
ON	L	H
OFF	L	H
ON	NC	L
OFF	NC	H

Absolute Maximum Ratings

$T_{amb} = 25\text{ }^{\circ}\text{C}$, unless otherwise specified

Stresses in excess of the absolute Maximum Ratings can cause permanent damage to the device. Functional operation of the device is not implied at these or any other conditions in excess of those given in the operational sections of this document. Exposure to absolute Maximum Rating for extended periods of the time can adversely affect reliability.

Input

Parameter	Test condition	Symbol	Value	Unit
Average forward current		I_F	15	mA
Reverse input voltage		V_R	5	V
Surge current	$t = 100\text{ }\mu\text{s}$	I_{FSM}	200	mA

Output

Parameter	Test condition	Symbol	Value	Unit
Supply voltage	1 minute max.	V_{CC}	7	V
Output current		I_O	50	mA
Output voltage		V_O	7	V
Output power dissipation per channel		P_{diss}	60	mW

Coupler

Parameter	Test condition	Symbol	Value	Unit
Storage temperature		T_{stg}	- 55 to + 150	$^{\circ}\text{C}$
Operating temperature		T_{amb}	- 40 to + 100	$^{\circ}\text{C}$
Lead solder temperature	for 10 sec.		260	$^{\circ}\text{C}$
Solder reflow temperature	for 1 minute		260	$^{\circ}\text{C}$
Isolation test voltage	$t = 1.0\text{ sec.}$	V_{ISO}	3000	V_{RMS}

Recommended Operating Conditions

Parameter	Test condition	Symbol	Min	Typ.	Max	Unit
Operating temperature		T_{amb}	- 40		100	$^{\circ}\text{C}$
Supply voltage		V_{CC}	4.5		5.5	V
Input current low level		I_{FL}	0		250	μA
Input current high level		I_{FH}	5		15	mA
Output pull up resistor		R_L	330		4 K	Ω
Fanout	$R_L = 1\text{ k}\Omega$	N			5	-

Electrical Characteristics

$T_{amb} = 25\text{ °C}$ and $V_{CC} = 5.5\text{ V}$, unless otherwise specified

Minimum and maximum values are testing requirements. Typical values are characteristics of the device and are the result of engineering evaluation. Typical values are for information only and are not part of the testing requirements.

Input

Parameter	Test condition	Symbol	Min	Typ.	Max	Unit
Input forward voltage	$I_F = 10\text{ mA}$	V_F	1.1	1.4	1.7	V
Reverse current	$V_R = 5.0\text{ V}$	I_R		0.01	10	μA
Input capacitance	$f = 1\text{ MHz}, V_F = 0\text{ V}$	C_I		55		pF

Output

Parameter	Test condition	Symbol	Min	Typ.	Max	Unit
High level supply current (single channel)	$V_E = 0.5\text{ V}, I_F = 0\text{ mA}$	I_{CCH}		4.1	7.0	mA
	$V_E = V_{CC}, I_F = 0\text{ mA}$	I_{CCH}		3.3	6.0	mA
High level supply current (dual channel)	$I_F = 0\text{ mA}$	I_{CCH}		6.5	12.0	mA
Low level supply current (single channel)	$V_E = 0.5\text{ V}, I_F = 10\text{ mA}$	I_{CCL}		4.0	7.0	mA
	$V_E = V_{CC}, I_F = 10\text{ mA}$	I_{CCL}		3.3	6.0	mA
Low level supply current (dual channel)	$I_F = 10\text{ mA}$	I_{CCL}		6.5	12.0	mA
High level output current	$V_E = 2.0\text{ V}, V_O = 5.5\text{ V}, I_F = 250\text{ }\mu\text{A}$	I_{OH}		0.002	1	μA
Low level output voltage	$V_E = 2.0\text{ V}, I_F = 5\text{ mA}, I_{OL}(\text{sinking}) = 13\text{ mA}$	V_{OL}		0.2	0.6	V
Input threshold current	$V_E = 2.0\text{ V}, V_O = 5.5\text{ V}, I_{OL}(\text{sinking}) = 13\text{ mA}$	I_{TH}		2.4	5.0	mA

Switching Characteristics

Over Recommended Temperature ($T_a = -40\text{ to }+100\text{ °C}$), $V_{CC} = 5\text{ V}, I_F = 7.5\text{ mA}$ unless otherwise specified.

All Typicals at $T_a = 25\text{ °C}, V_{CC} = 5\text{ V}$.

Parameter	Test condition	Symbol	Min	Typ.	Max	Unit
Propagation delay time to high output level	$R_L = 350\text{ }\Omega, C_L = 15\text{ pF}$	t_{PLH}	20	48	100	ns
Propagation delay time to low output level	$R_L = 350\text{ }\Omega, C_L = 15\text{ pF}$	t_{PHL}	25	50	100	ns
Pulse width distortion	$R_L = 350\text{ }\Omega, C_L = 15\text{ pF}$	$ t_{PHL} - t_{PLH} $		2.9	35	ns
Propagation delay skew	$R_L = 350\text{ }\Omega, C_L = 15\text{ pF}$	t_{PSK}		8	40	ns
Output rise time (10 - 90 %)	$R_L = 350\text{ }\Omega, C_L = 15\text{ pF}$	t_r		23		ns
Output fall time (90 - 10 %)	$R_L = 350\text{ }\Omega, C_L = 15\text{ pF}$	t_f		7		ns

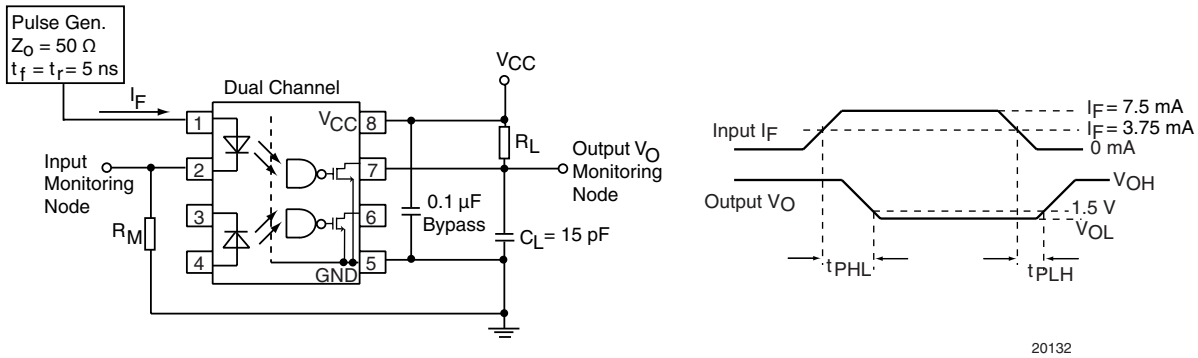

Figure 1. Dual Channel Test Circuit for t_{PLH} , t_{PHL} , t_r and t_f

Common Mode Transient Immunity

Parameter	Test condition	Symbol	Min	Typ.	Max	Unit
Common mode transient immunity (high)	$ V_{CM} = 10 \text{ V}$, $V_{CC} = 5 \text{ V}$, $I_F = 0 \text{ mA}$, $V_{O(\min)} = 2 \text{ V}$, $R_L = 350 \Omega$, $T_{\text{amb}} = 25 \text{ }^\circ\text{C}^1$	$ CM_H $	100			V/ μs
	$ V_{CM} = 50 \text{ V}$, $V_{CC} = 5 \text{ V}$, $I_F = 0 \text{ mA}$, $V_{O(\min)} = 2 \text{ V}$, $R_L = 350 \Omega$, $T_{\text{amb}} = 25 \text{ }^\circ\text{C}^2$	$ CM_H $	5000	10000		V/ μs
	$ V_{CM} = 1 \text{ kV}$, $V_{CC} = 5 \text{ V}$, $I_F = 0 \text{ mA}$, $V_{O(\min)} = 2 \text{ V}$, $R_L = 350 \Omega$, $T_{\text{amb}} = 25 \text{ }^\circ\text{C}^3$	$ CM_H $	10000	15000		V/ μs
Common mode transient immunity (low)	$ V_{CM} = 10 \text{ V}$, $V_{CC} = 5 \text{ V}$, $I_F = 7.5 \text{ mA}$, $V_{O(\max)} = 0.8 \text{ V}$, $R_L = 350 \Omega$, $T_{\text{amb}} = 25 \text{ }^\circ\text{C}^1$	$ CM_L $	100			V/ μs
	$ V_{CM} = 50 \text{ V}$, $V_{CC} = 5 \text{ V}$, $I_F = 7.5 \text{ mA}$, $V_{O(\max)} = 0.8 \text{ V}$, $R_L = 350 \Omega$, $T_{\text{amb}} = 25 \text{ }^\circ\text{C}^2$	$ CM_L $	5000	10000		V/ μs
	$ V_{CM} = 1 \text{ kV}$, $V_{CC} = 5 \text{ V}$, $I_F = 7 \text{ mA}$, $V_{O(\max)} = 0.8 \text{ V}$, $R_L = 350 \Omega$, $T_{\text{amb}} = 25 \text{ }^\circ\text{C}^3$	$ CM_L $	10000	15000		V/ μs

1) For SFH6755T

2) For SFH6756T

3) For SFH6757T

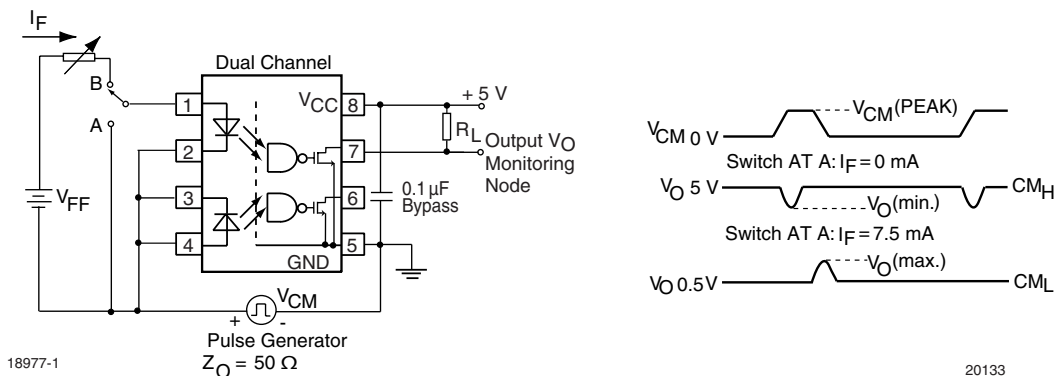

Figure 2. Dual Channel Test Circuit for Common Mode Transient Immunity

Safety and Insulation Ratings

As per IEC60747-5-2, §7.4.3.8.1, this optocoupler is suitable for "safe electrical insulation" only within the safety ratings. Compliance with the safety ratings shall be ensured by means of protective circuits.

Parameter	Test condition	Symbol	Min	Typ.	Max	Unit
Climatic Classification (according to IEC 68 part 1)				55/110/21		
Comparative Tracking Index		CTI	175		399	
V_{IOTM}			5000			V
V_{IORM}			560			V
P_{SO}					350	mW
I_{SI}					150	mA
T_{SI}					165	°C
Creepage			5			mm
Clearance			4			mm
Insulation thickness, reinforced rated	per IEC60950 2.10.5.1		0.2			mm

Typical Characteristics

$T_{amb} = 25\text{ °C}$ unless otherwise specified

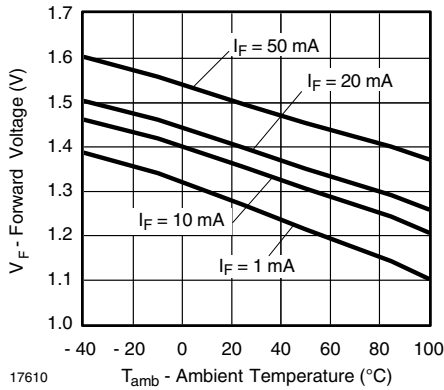

Figure 3. Forward Voltage vs. Ambient Temperature

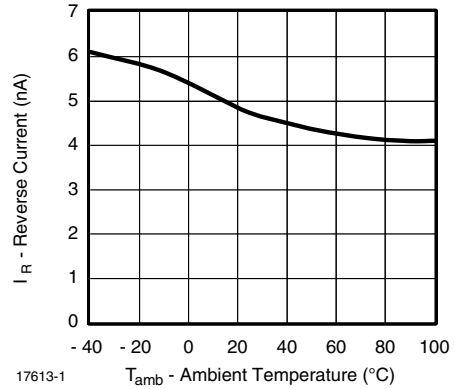

Figure 5. Reverse Current vs. Ambient Temperature

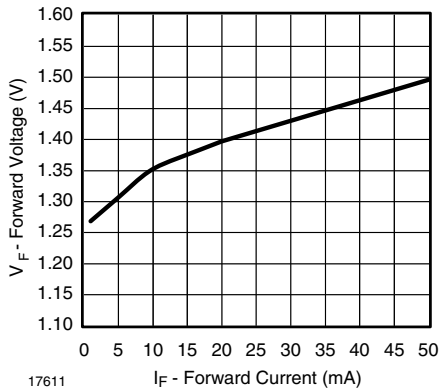

Figure 4. Forward Voltage vs. Forward Current

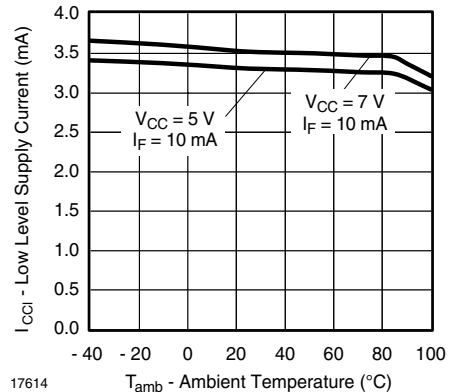

Figure 6. Low Level Supply Current vs. Ambient Temperature

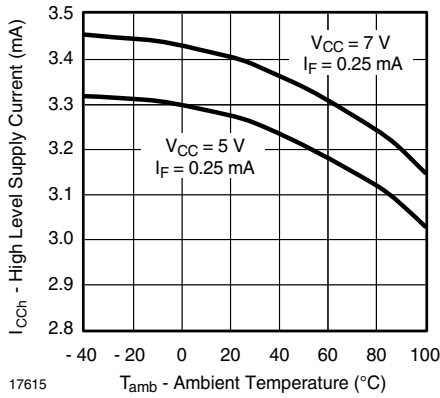

Figure 7. High Level Supply Current vs. Ambient Temperature

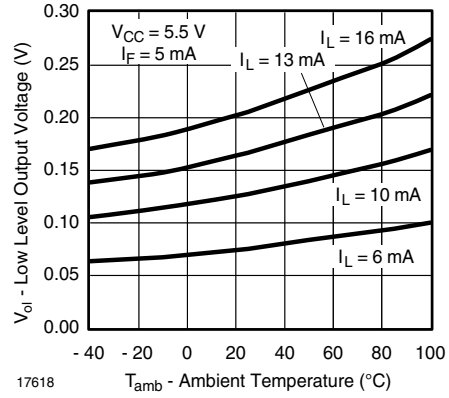

Figure 10. Low Level Output Voltage vs. Ambient Temperature

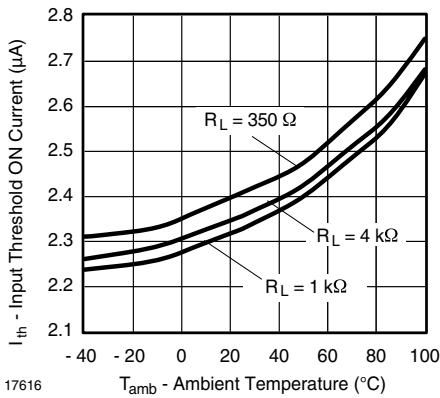

Figure 8. Input Threshold ON Current vs. Ambient Temperature

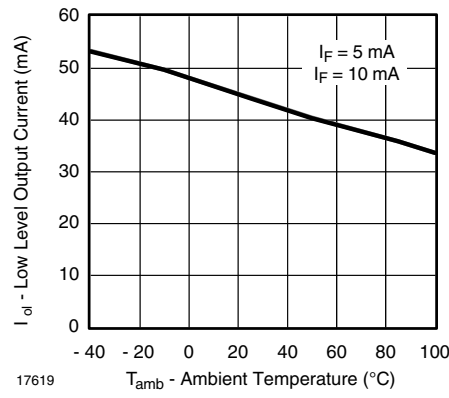

Figure 11. Low Level Output Current vs. Ambient Temperature

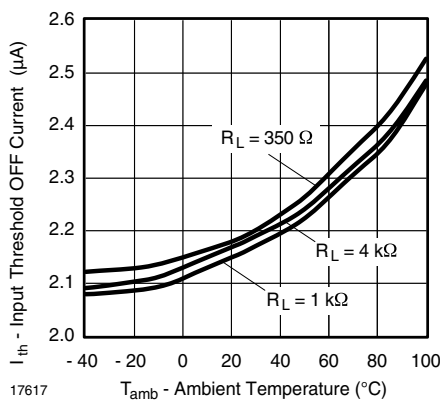

Figure 9. Input Threshold OFF Current vs. Ambient Temperature

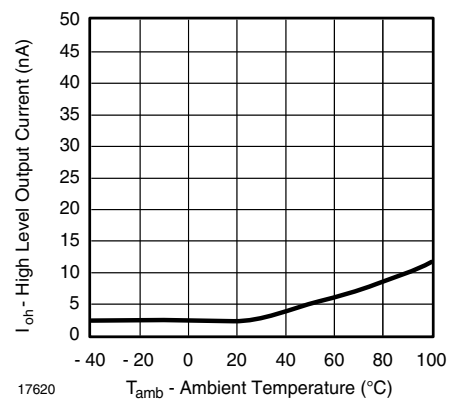

Figure 12. High Level Output Current vs. Ambient Temperature

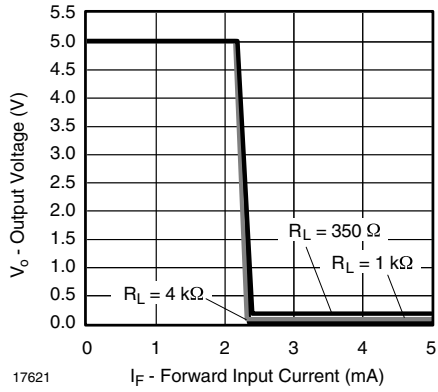

Figure 13. Output Voltage vs. Forward Input Current

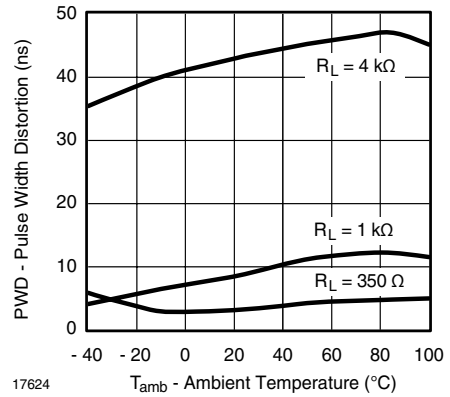

Figure 16. Pulse Width Distortion vs. Ambient Temperature

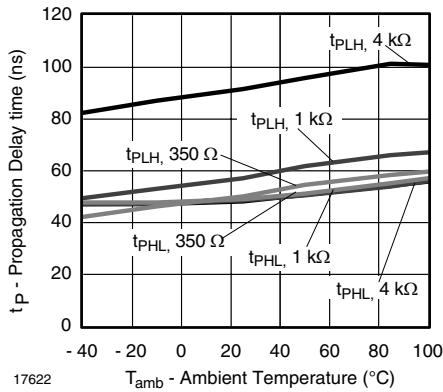

Figure 14. Propagation Delay vs. Ambient Temperature

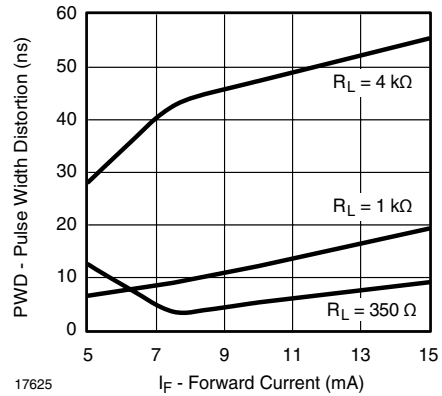

Figure 17. Pulse Width Distortion vs. Forward Current

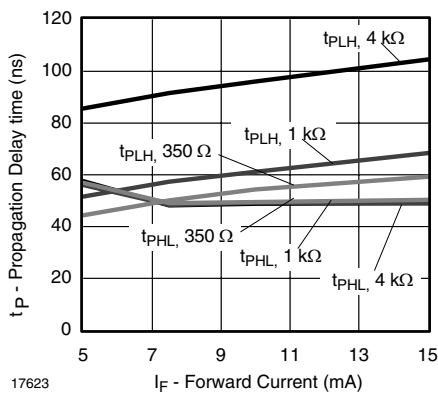

Figure 15. Propagation Delay vs. Forward Current

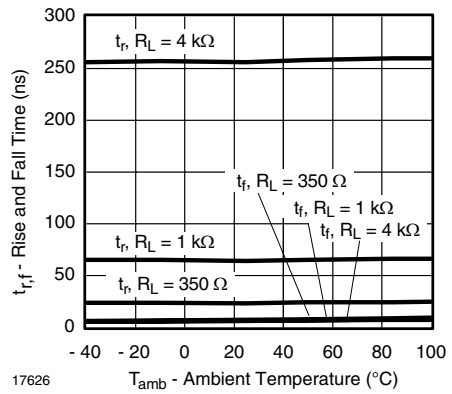

Figure 18. Rise and Fall Time vs. Ambient Temperature

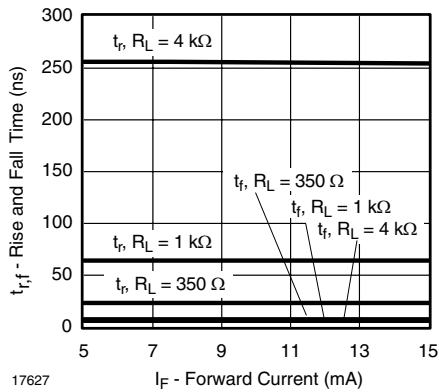
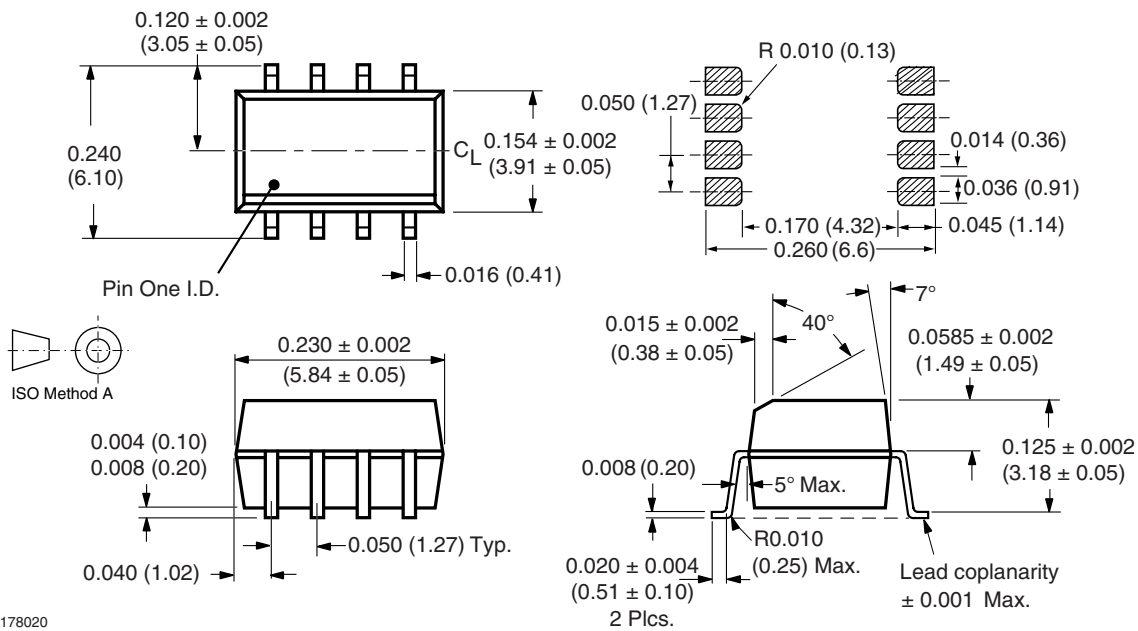

Figure 19. Rise and Fall Time vs. Forward Current

Package Dimensions in Inches (mm)

Dual Channel SOIC-8



i178020

ESD Caution

This is an ESD (electro static discharge) sensitive device. Electrostatic charges accumulate on the human body and test equipment and can discharge without detection. Therefore, proper ESD precautions are recommended to avoid performance degradation or loss of functionality. ESD withstand voltage of this device is up to 1500 V acc. to JESD22-A114-B.

Ozone Depleting Substances Policy Statement

It is the policy of Vishay Semiconductor GmbH to

1. Meet all present and future national and international statutory requirements.
2. Regularly and continuously improve the performance of our products, processes, distribution and operating systems with respect to their impact on the health and safety of our employees and the public, as well as their impact on the environment.

It is particular concern to control or eliminate releases of those substances into the atmosphere which are known as ozone depleting substances (ODSs).

The Montreal Protocol (1987) and its London Amendments (1990) intend to severely restrict the use of ODSs and forbid their use within the next ten years. Various national and international initiatives are pressing for an earlier ban on these substances.

Vishay Semiconductor GmbH has been able to use its policy of continuous improvements to eliminate the use of ODSs listed in the following documents.

1. Annex A, B and list of transitional substances of the Montreal Protocol and the London Amendments respectively
2. Class I and II ozone depleting substances in the Clean Air Act Amendments of 1990 by the Environmental Protection Agency (EPA) in the USA
3. Council Decision 88/540/EEC and 91/690/EEC Annex A, B and C (transitional substances) respectively.

Vishay Semiconductor GmbH can certify that our semiconductors are not manufactured with ozone depleting substances and do not contain such substances.

We reserve the right to make changes to improve technical design and may do so without further notice.

Parameters can vary in different applications. All operating parameters must be validated for each customer application by the customer. Should the buyer use Vishay Semiconductors products for any unintended or unauthorized application, the buyer shall indemnify Vishay Semiconductors against all claims, costs, damages, and expenses, arising out of, directly or indirectly, any claim of personal damage, injury or death associated with such unintended or unauthorized use.

Vishay Semiconductor GmbH, P.O.B. 3535, D-74025 Heilbronn, Germany



Notice

Specifications of the products displayed herein are subject to change without notice. Vishay Intertechnology, Inc., or anyone on its behalf, assumes no responsibility or liability for any errors or inaccuracies.

Information contained herein is intended to provide a product description only. No license, express or implied, by estoppel or otherwise, to any intellectual property rights is granted by this document. Except as provided in Vishay's terms and conditions of sale for such products, Vishay assumes no liability whatsoever, and disclaims any express or implied warranty, relating to sale and/or use of Vishay products including liability or warranties relating to fitness for a particular purpose, merchantability, or infringement of any patent, copyright, or other intellectual property right.

The products shown herein are not designed for use in medical, life-saving, or life-sustaining applications. Customers using or selling these products for use in such applications do so at their own risk and agree to fully indemnify Vishay for any damages resulting from such improper use or sale.