

FEATURES

- 2-way or 3-way, 2 position valve (NO, NC & Distributor)
- Offer a discrete valve design with a 200 million life cycle rating
- Available in manifold mounting
- Provide a range of electrical coil options, including PC mountable, spade lugs, or wire leads
- Powerful enough for a range of uses that require high flow

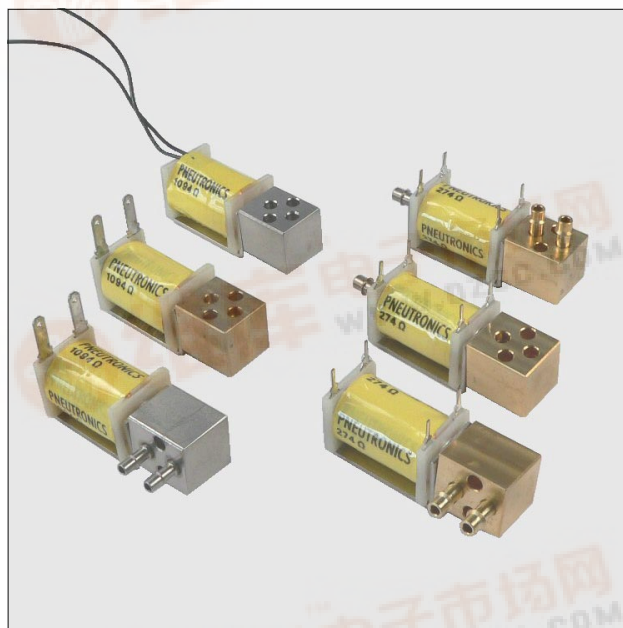

MEDIA COMPATIBILITY

Gases and selected liquids

WETTED MATERIALS

Body:

360 HO2 brass;

302 series stainless steel (passivated)

Stem base:

385 HO2 brass;

303 series stainless steel (passivated)

All others:

FKM; EPDM; 430 FR series stainless steel

(passivated); 302 series stainless steel

ELECTRICAL

Power 0.5, 1.0 or 2.0 W

Voltage 5, 12, 24 V_{DC} ± 10%

PHYSICAL PROPERTIES

Operating environment 0 to 70 °C

Storage temperature -40 to 70 °C

Length 43.9 mm (1.73 in)

Width 15.9 mm (0.625 in)

Height 17 mm (0.67 in)

Porting 10-32 tapped ports,
1/16, 5/64 or 1/8 in stem barbs

Weight 60 g (2.1 oz)

Internal volume 0.026 in³ (without fittings)

Filtration (recommended) 40 µm

Lubrication None required

PERFORMANCE CHARACTERISTICS

Part no.	Pressure	Vacuum	Orifice sizes/ Equivalent C_v ¹	Leak rate ²	Response
1110...	0...100 psig	0...27 "Hg (0...13 psi)	0.030" (0.762 mm)/ 0.017 C_v	≤0.016 sccm (bubble tight)	<30 msec cycling (2 Watt)
1113...	0...50 psig				
1116...	0...25 psig				
1112...	0...70 psig		0.050" (1.270 mm)/ 0.035 C_v		<30 msec cycling (2 Watt)
1115...	0...25 psig				
1118...	0...10 psig				

FLOW CURVE (typical air flow)³

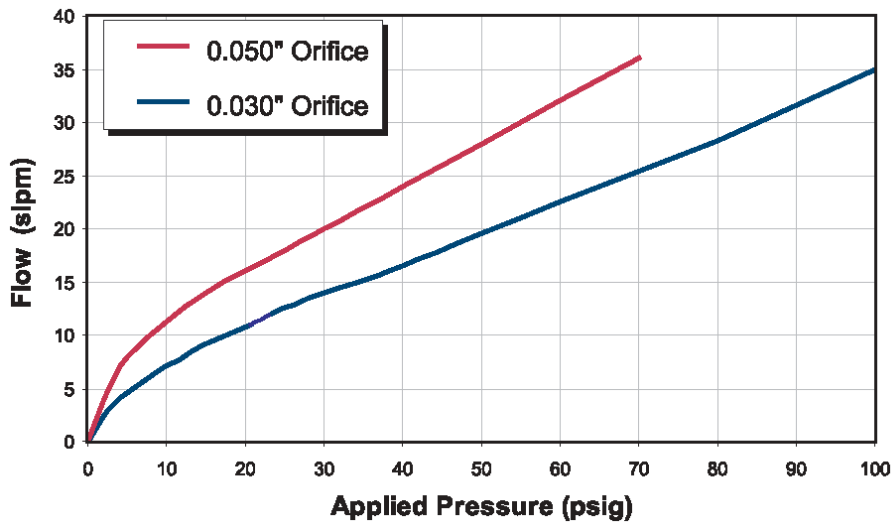

Notes:

- ¹ The C_v value is the volume flow in US gallons/min under specific flow conditions and describes the relative flow capacity of a valve. If several valves with the same nominal diameter are compared, the valve with the highest C_v value has the best flow dynamics design. The equivalent european measure is the k_v value expressed in m^3/h ($k_v = 0.86 C_v$).
- ² sccm denotes Standard Cubic Centimeters per Minute. It is a unit for the flow rate at standard conditions of temperature and pressure. 1000 sccm = 1 slpm.
- ³ slpm denotes Standard Liters per Minute. It is a unit for the flow rate at standard conditions of temperature and pressure. 1 slpm = 1000 sccm.

OUTLINE DRAWING

Basic dimensions

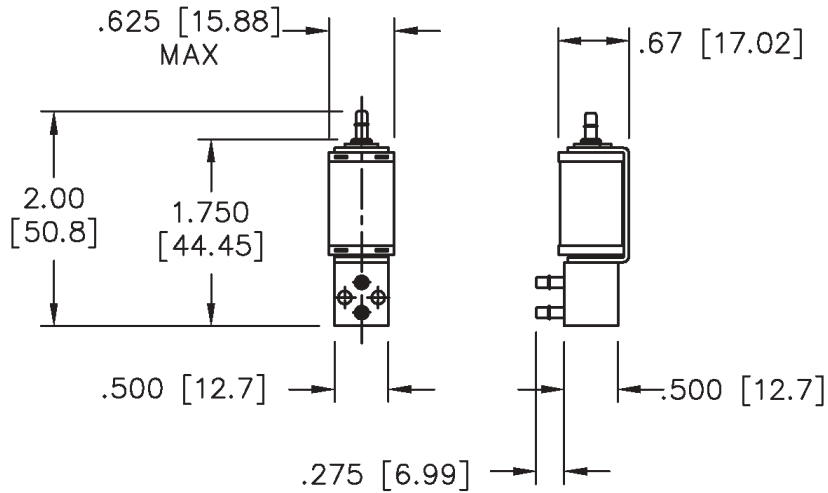

Port and mounting hole diagram

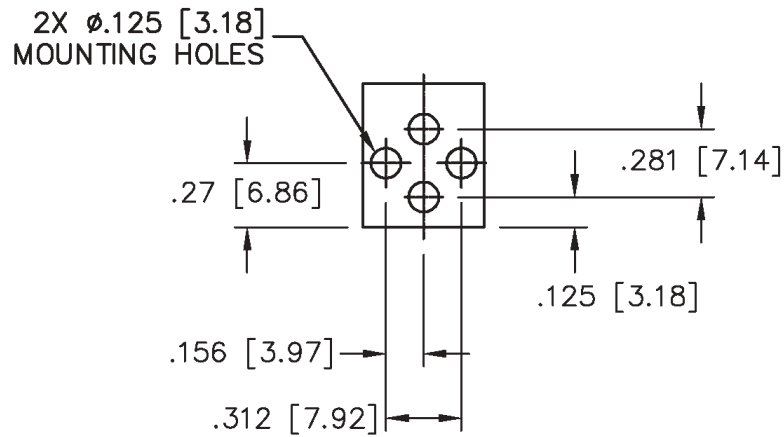

PC mounting diagram

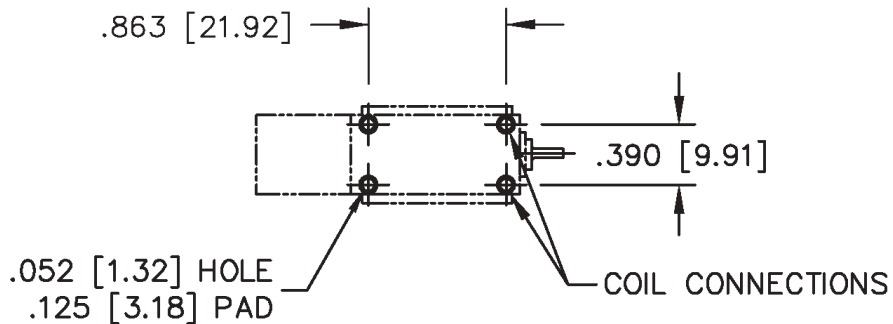

VALVE TYPE

Type 1

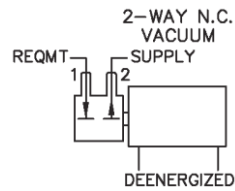
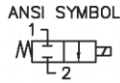
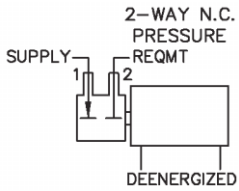

Type 2

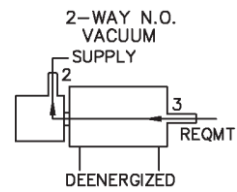
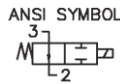
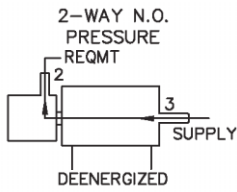

Type 3

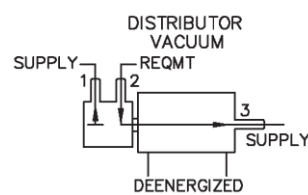
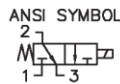
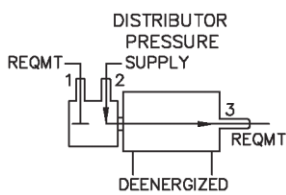
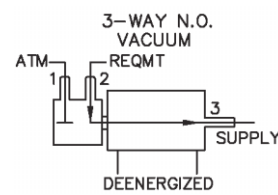
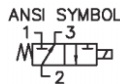
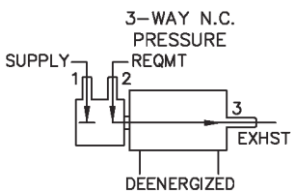

Type 4

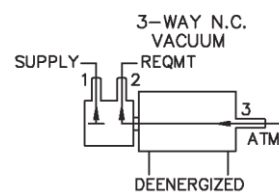
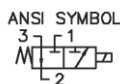
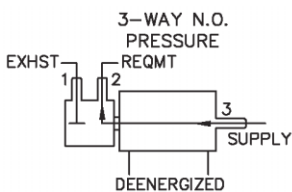

COIL STYLES

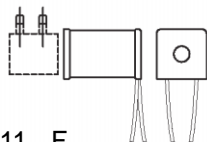

11...F...
(Wire leads, no terminals)

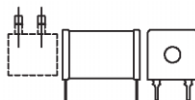

11...P...
(PC mount, 4 PC pins)

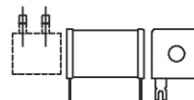

11...S...
(PC mount, 2 solder pads)

BODY STYLES



11...0...
(No barbs,
face seal to manifold)



11...6...
(0.062" barbs,
1/16" I.D. tubing)



11...7...
(0.078" barbs,
5/64" I.D. tubing)



11...8...
(0.125" barbs,
1/8" I.D. tubing,
1/4" O.D. max.)

STEM STYLES



11...0
(Type 1 top seat,
plugged)



11...6
(0.062" top seat,
1/16" I.D. tubing)



11...7
(0.078" top seat,
5/64" I.D. tubing)



11...8
(0.125" top seat,
1/8" I.D. tubing,
1/4" O.D. max.)

ORDERING INFORMATION

Options	Series	Model no.			Type	Material		Voltage		Coil type	Pneumatic connection body	Pneumatic connection stem						
		Max. pressure	Orifice size	Coil wattage		Body	Plunger & seal											
	11	10:	0...100 psi	0.030" (0.762 mm)	2 W	1:	2-way NC	BV:	brass	FKM	5:	5 V _{DC}	P:	4 PC pins	0:	no barbs	0:	type 1/ none
		12:	0...70 psi	0.050" (1.27 mm)	2 W	2:	2-way NO	SV:	SS*	FKM	12:	12 V _{DC}	S:	2 solder taps	6:	1/16" barbs	6:	1/16" barbs*
		13:	0...50 psi	0.030" (0.762 mm)	1 W	3:	3-way NC or distributor	BE:	brass	EPDM	24:	24 V _{DC}	Q:	Quick connect	7:	5/64" barbs	7:	5/64" barbs
		15:	0...25 psi	0.050" (1.27 mm)	1 W	4:	3-way NO						F:	Wire leads, 18", no terminals	8:	1/8" barbs	8:	1/8" barbs
		16:	0...25 psi	0.030" (0.762 mm)	0.5 W													
		18:	0...10 psi	0.050" (1.27 mm)	0.5 W													
						*Stainless steel								*1/16" barbs not available for 0.050" orifice				
Example:	11	10				3		BV			12		P		7			7

Note: Not all combinations might be available.
Please contact your nearest Sensortech sales representative for further information.

Sensortech reserves the right to make changes to any products herein. Sensortech does not assume any liability arising out of the application or use of any product or circuit described herein, neither does it convey any license under its patent rights nor the rights of others.