

RF Power Field Effect Transistors

N-Channel Enhancement-Mode Lateral MOSFETs

Designed for GSM and GSM EDGE base station applications with frequencies from 1805 to 1880 MHz. Can be used in Class AB and Class C for all typical cellular base station modulation formats.

- Typical GSM Performance: $V_{DD} = 28$ Volts, $I_{DQ} = 800$ mA, $P_{out} = 72$ Watts CW

Frequency	G_{ps} (dB)	η_D (%)
1805 MHz	18.2	49.8
1840 MHz	18.6	51.4
1880 MHz	18.7	53.9

- Capable of Handling 7:1 VSWR, @ 32 Vdc, 1840 MHz, 150 Watts CW Output Power (3 dB Input Overdrive from Rated P_{out})
- Typical P_{out} @ 1 dB Compression Point ≈ 120 Watts CW
- Typical GSM EDGE Performance: $V_{DD} = 28$ Volts, $I_{DQ} = 800$ mA, $P_{out} = 46$ Watts Avg.

Frequency	G_{ps} (dB)	η_D (%)	SR1 @ 400 kHz (dBc)	SR2 @ 600 kHz (dBc)	EVM (% rms)
1805 MHz	17.9	41.0	-64	-76	1.6
1840 MHz	18.2	41.9	-63	-76	1.7
1880 MHz	18.3	43.2	-61	-76	2.0

Features

- Characterized with Series Equivalent Large-Signal Impedance Parameters and Common Source S-Parameters
- Internally Matched for Ease of Use
- Integrated ESD Protection
- Greater Negative Gate-Source Voltage Range for Improved Class C Operation
- Optimized for Doherty Applications
- RoHS Compliant
- In Tape and Reel. R3 Suffix = 250 Units per 56 mm, 13 inch Reel.

Table 1. Maximum Ratings

Rating	Symbol	Value	Unit
Drain-Source Voltage	V_{DSS}	-0.5, +65	Vdc
Gate-Source Voltage	V_{GS}	-6.0, +10	Vdc
Operating Voltage	V_{DD}	32, +0	Vdc
Storage Temperature Range	T_{stg}	-65 to +150	°C
Case Operating Temperature	T_C	150	°C
Operating Junction Temperature (1,2)	T_J	225	°C

1. Continuous use at maximum temperature will affect MTTF.

2. MTTF calculator available at <http://www.freescale.com/rf>. Select Software & Tools/Development Tools/Calculators to access MTTF calculators by product.

MRF8S18120HR3
MRF8S18120HSR3

1805-1880 MHz, 72 W CW, 28 V
GSM, GSM EDGE
LATERAL N-CHANNEL
RF POWER MOSFETs

CASE 465-06, STYLE 1
NI-780
MRF8S18120HR3

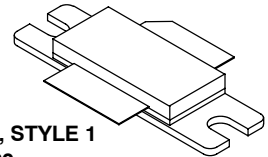

CASE 465A-06, STYLE 1
NI-780S
MRF8S18120HSR3

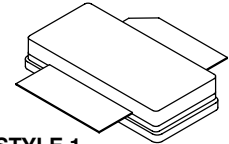

Table 2. Thermal Characteristics

Characteristic	Symbol	Value (1,2)	Unit
Thermal Resistance, Junction to Case Case Temperature 79°C, 72 W CW, 28 Vdc, I _{DQ} = 800 mA Case Temperature 79°C, 120 W CW, 28 Vdc, I _{DQ} = 800 mA	R _{θJC}	0.47 0.46	°C/W

Table 3. ESD Protection Characteristics

Test Methodology	Class
Human Body Model (per JESD22-A114)	2 (Minimum)
Machine Model (per EIA/JESD22-A115)	A (Minimum)
Charge Device Model (per JESD22-C101)	IV (Minimum)

Table 4. Electrical Characteristics (T_A = 25°C unless otherwise noted)

Characteristic	Symbol	Min	Typ	Max	Unit
----------------	--------	-----	-----	-----	------

Off Characteristics

Zero Gate Voltage Drain Leakage Current (V _{DS} = 65 Vdc, V _{GS} = 0 Vdc)	I _{DSS}	—	—	10	μAdc
Zero Gate Voltage Drain Leakage Current (V _{DS} = 28 Vdc, V _{GS} = 0 Vdc)	I _{DSS}	—	—	1	μAdc
Gate-Source Leakage Current (V _{GS} = 5 Vdc, V _{DS} = 0 Vdc)	I _{GSS}	—	—	1	μAdc

On Characteristics

Gate Threshold Voltage (V _{DS} = 10 Vdc, I _D = 260 μAdc)	V _{GS(th)}	1.2	1.8	2.7	Vdc
Gate Quiescent Voltage (V _{DD} = 28 Vdc, I _D = 800 mAdc, Measured in Functional Test)	V _{GS(Q)}	1.8	2.6	3.3	Vdc
Drain-Source On-Voltage (V _{GS} = 10 Vdc, I _D = 2.3 Adc)	V _{DS(on)}	0.1	0.2	0.3	Vdc

Functional Tests ⁽³⁾ (In Freescale Test Fixture, 50 ohm system) V_{DD} = 28 Vdc, I_{DQ} = 800 mA, P_{out} = 72 W CW, f = 1805 MHz

Power Gain	G _{ps}	17	18.2	20	dB
Drain Efficiency	η _D	48	49.8	—	%
Input Return Loss	IRL	—	-11	-8	dB
P _{out} @ 1 dB Compression Point, CW	P1dB	112	—	—	W

Typical Broadband Performance (In Freescale Test Fixture, 50 ohm system) V_{DD} = 28 Vdc, I_{DQ} = 800 mA, P_{out} = 72 W CW

Frequency	G _{ps} (dB)	η _D (%)	IRL (dB)
1805 MHz	18.2	49.8	-11
1840 MHz	18.6	51.4	-15
1880 MHz	18.7	53.9	-12

1. MTTF calculator available at <http://www.freescale.com/rf>. Select Software & Tools/Development Tools/Calculators to access MTTF calculators by product.
2. Refer to AN1955, *Thermal Measurement Methodology of RF Power Amplifiers*. Go to <http://www.freescale.com/rf>. Select Documentation/Application Notes - AN1955.
3. Part internally matched both on input and output.

(continued)

Table 4. Electrical Characteristics ($T_A = 25^\circ\text{C}$ unless otherwise noted) (continued)

Characteristic	Symbol	Min	Typ	Max	Unit
Typical Performances (In Freescale Test Fixture, 50 ohm system) $V_{DD} = 28\text{ Vdc}$, $I_{DQ} = 800\text{ mA}$, 1805–1880 MHz Bandwidth					
P_{out} @ 1 dB Compression Point, CW	P1dB	—	120	—	W
IMD Symmetry @ 94 W PEP, P_{out} where IMD Third Order Intermodulation $\cong 30\text{ dBc}$ (Delta IMD Third Order Intermodulation between Upper and Lower Sidebands $> 2\text{ dB}$)	IMD _{sym}	—	10	—	MHz
VBW Resonance Point (IMD Third Order Intermodulation Inflection Point)	VBW _{res}	—	35	—	MHz
Gain Flatness in 75 MHz Bandwidth @ $P_{out} = 72\text{ W CW}$	G _F	—	0.5	—	dB
Gain Variation over Temperature (-30°C to $+85^\circ\text{C}$)	ΔG	—	0.01	—	dB/ $^\circ\text{C}$
Output Power Variation over Temperature (-30°C to $+85^\circ\text{C}$)	ΔP_{1dB}	—	0.004	—	dB/ $^\circ\text{C}$

Typical GSM EDGE Performances (In Freescale GSM EDGE Test Fixture, 50 ohm system) $V_{DD} = 28\text{ Vdc}$, $I_{DQ} = 800\text{ mA}$, $P_{out} = 46\text{ W Avg.}$, 1805–1880 MHz EDGE Modulation

Frequency	G _{ps} (dB)	η_D (%)	SR1 @ 400 kHz (dBc)	SR2 @ 600 kHz (dBc)	EVM (% rms)
1805 MHz	17.9	41.0	-64	-76	1.6
1840 MHz	18.2	41.9	-63	-76	1.7
1880 MHz	18.3	43.2	-61	-76	2.0

[查询"MRF8S18120H"供应商](#)

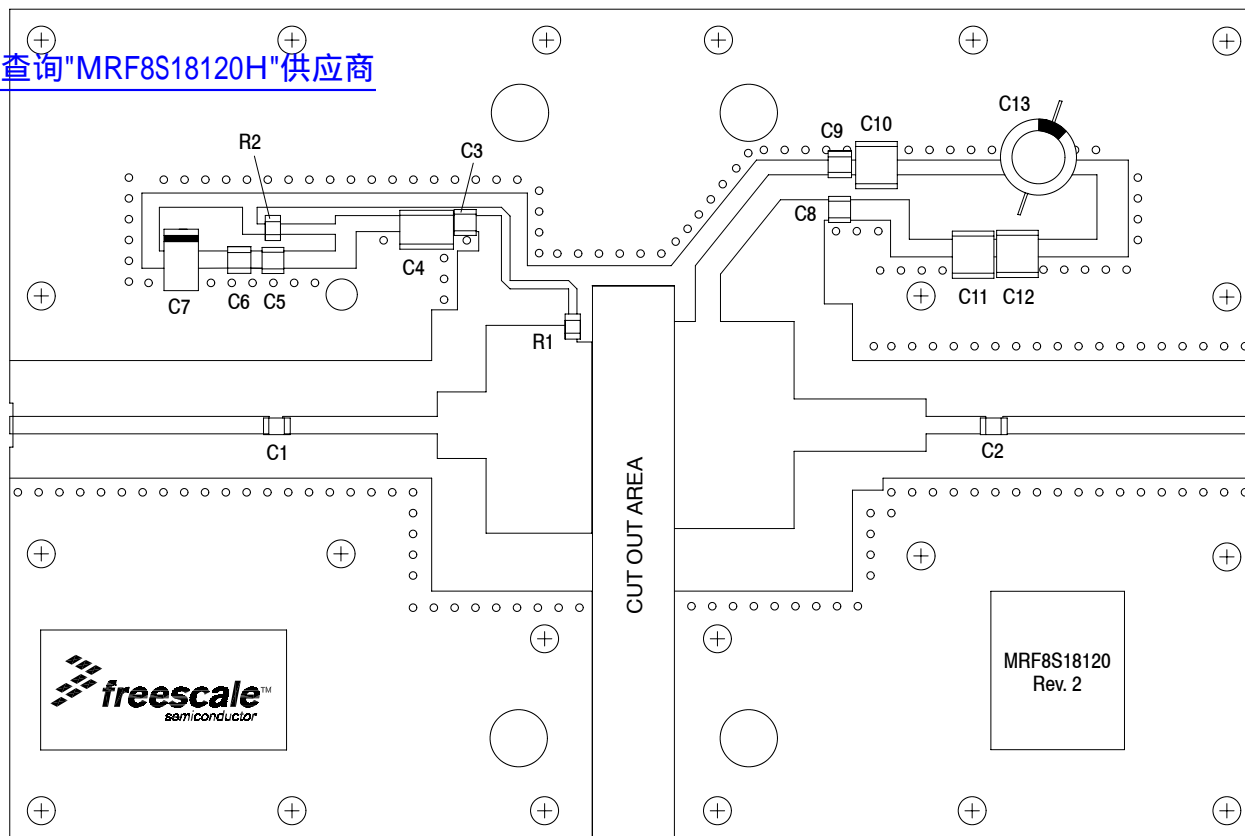

Figure 1. MRF8S18120HR3(HSR3) Test Circuit Component Layout

Table 5. MRF8S18120HR3(HSR3) Test Circuit Component Designations and Values

Part	Description	Part Number	Manufacturer
C1, C2	12 pF Chip Capacitors	ATC100B120JT500XT	ATC
C3, C8	9.1 pF Chip Capacitors	ATC100B9R1CT500XT	ATC
C4	10 nF Chip Capacitor	C1825C103K1GAC-TU	Kemet
C5	8.2 pF Chip Capacitor	ATC100B8R2CT500XT	ATC
C6, C9	2.2 μ F, 100 V Chip Capacitors	C3225X7R2A225KT	TDK
C7	47 μ F, 16 V Tantalum Capacitor	T491D476K016AT	Kemet
C10, C11, C12	10 μ F, 50 V Chip Capacitors	GRM55DR61H106KA88L	Murata
C13	330 μ F, 63 V Electrolytic Capacitor	MCRH63V337M13X21-RH	Multicomp
R1	10 Ω , 1/4 W Chip Resistor	CRCW120610R0JNEA	Vishay
R2	4.75 Ω , 1/4 W Chip Resistor	CRCW12064R75FNEA	Vishay
PCB	0.030", $\epsilon_r = 2.55$	250GX-0300-55-22	Arlon

TYPICAL CHARACTERISTICS

查询"MRF8S18120H"供应商

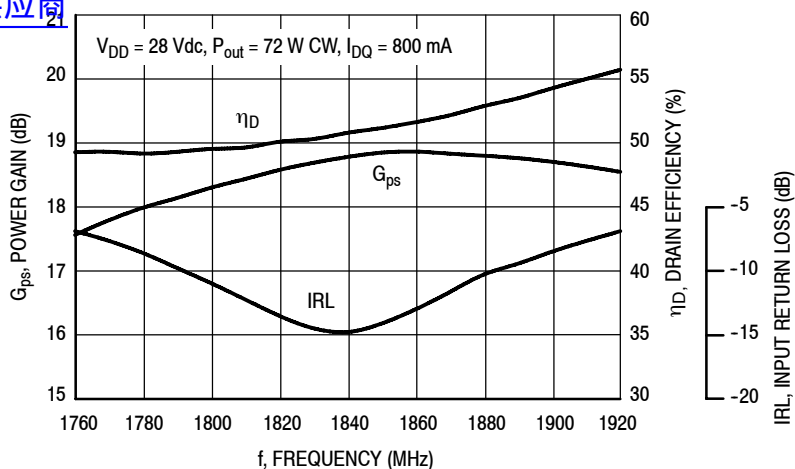

Figure 2. Power Gain, Input Return Loss and Drain Efficiency versus Frequency @ $P_{out} = 72$ Watts CW

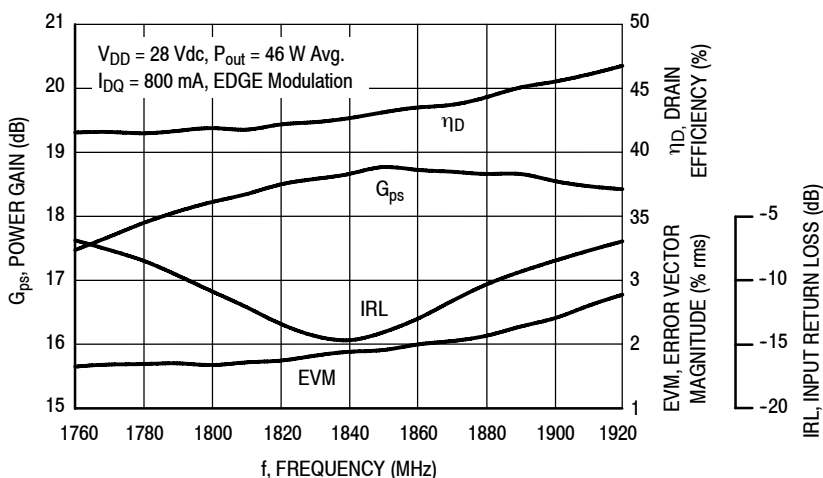

Figure 3. Power Gain, Input Return Loss, EVM and Drain Efficiency versus Frequency @ $P_{out} = 46$ Watts Avg.

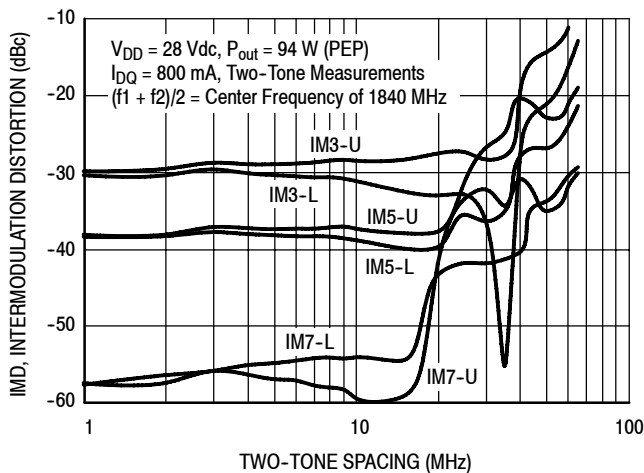

Figure 4. Intermodulation Distortion Products versus Two-Tone Spacing

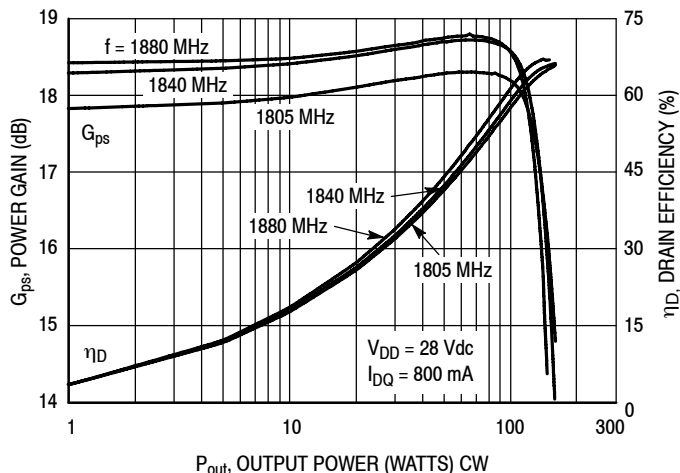

Figure 5. Power Gain and Drain Efficiency versus Output Power

MRF8S18120HR3 MRF8S18120HSR3

TYPICAL CHARACTERISTICS

查询"MRF8S18120H"供应商

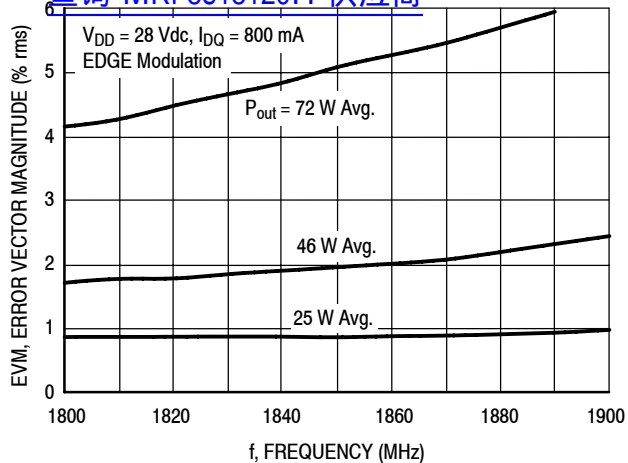

Figure 6. EVM versus Frequency

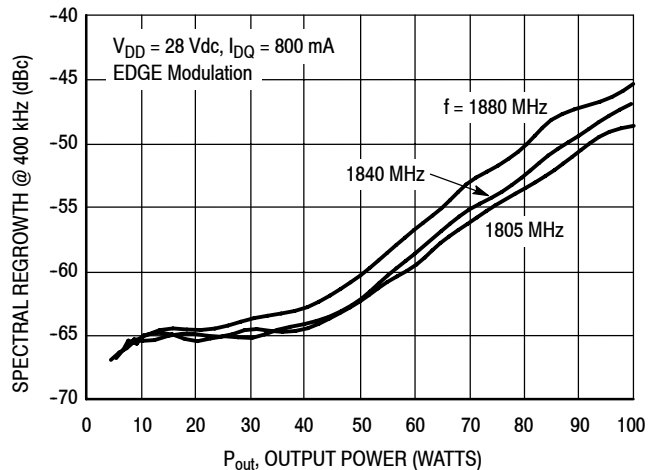

Figure 7. Spectral Regrowth at 400 kHz versus Output Power

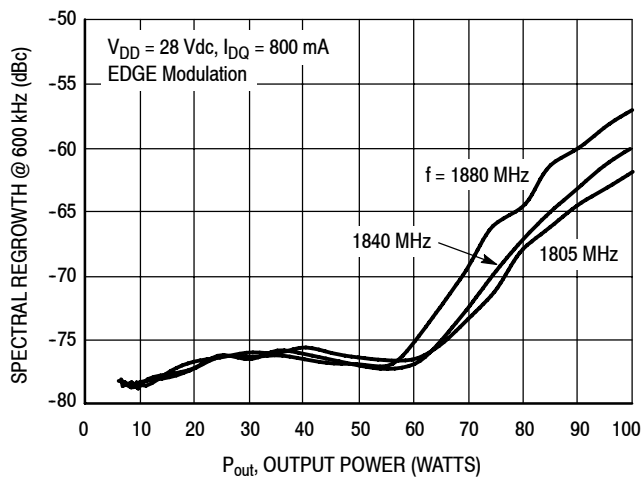

Figure 8. Spectral Regrowth at 600 kHz versus Output Power

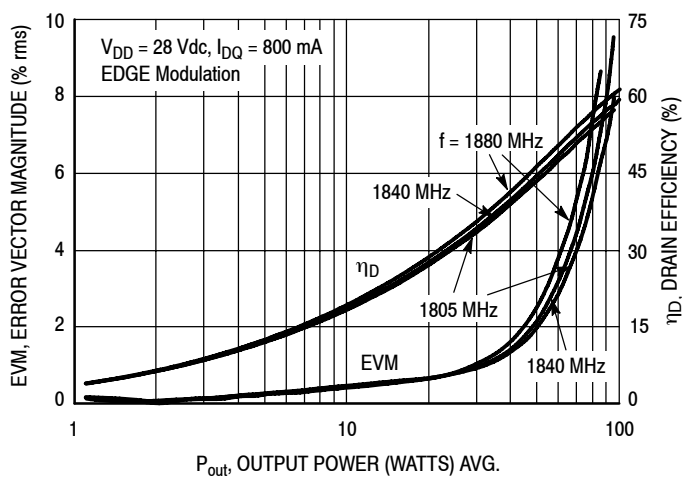

Figure 9. EVM and Drain Efficiency versus Output Power

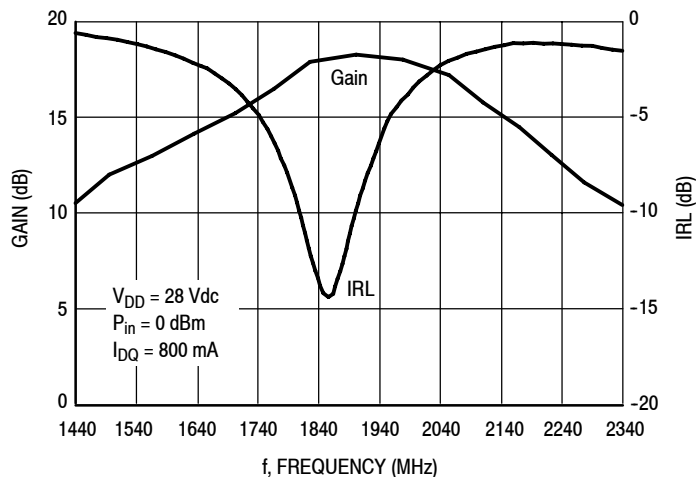

Figure 10. Broadband Frequency Response

GSM TEST SIGNAL

[查询"MRF8S18120H"供应商](#)

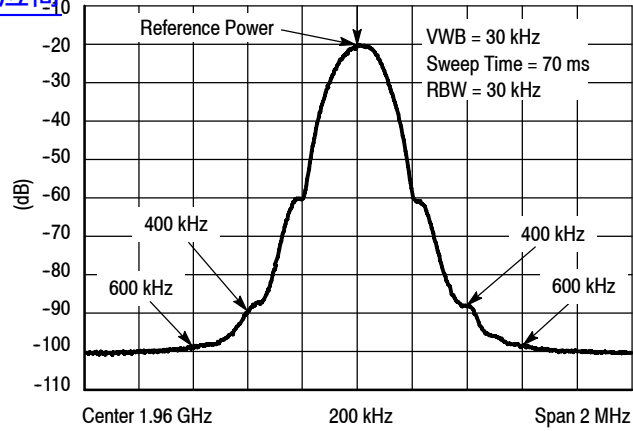

Figure 11. EDGE Spectrum

$V_{DD} = 28 \text{ Vdc}$, $I_{DQ} = 800 \text{ mA}$, $P_{out} = 72 \text{ W CW}$

f MHz	Z_{source} Ω	Z_{load} Ω
1760	$1.53 - j1.94$	$2.32 - j0.41$
1780	$1.53 - j1.82$	$2.31 - j0.51$
1800	$1.56 - j1.90$	$2.31 - j0.49$
1820	$1.56 - j1.86$	$2.32 - j0.40$
1840	$1.57 - j1.75$	$2.33 - j0.26$
1860	$1.51 - j1.64$	$2.29 - j0.12$
1880	$1.49 - j1.58$	$2.29 - j0.01$
1900	$1.49 - j1.55$	$2.29 + j0.05$
1920	$1.48 - j1.53$	$2.31 + j0.06$

Z_{source} = Test circuit impedance as measured from gate to ground.

Z_{load} = Test circuit impedance as measured from drain to ground.

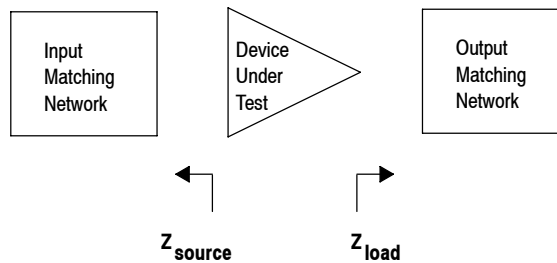
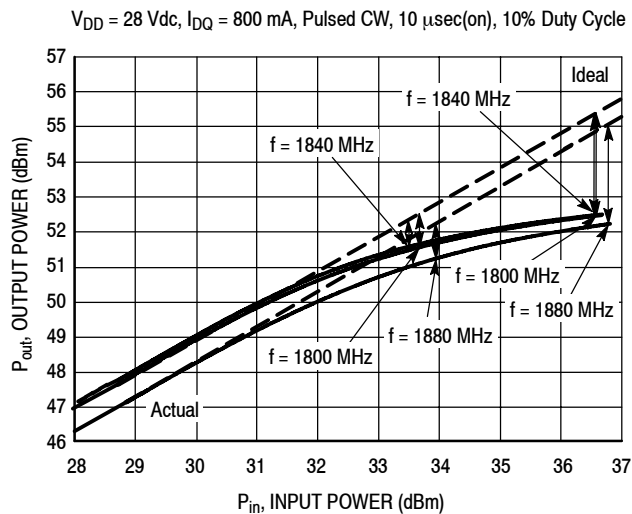

Figure 12. Series Equivalent Source and Load Impedance

ALTERNATIVE PEAK TUNE LOAD PULL CHARACTERISTICS

[查询"MRF8S18120H"供应商](#)



NOTE: Load Pull Test Fixture Tuned for Peak P1dB Output Power @ 28 V

f (MHz)	P1dB		P3dB	
	Watts	dBm	Watts	dBm
1805	145	51.6	178	52.5
1840	141	51.5	178	52.5
1880	135	51.3	170	52.3

Test Impedances per Compression Level

f (MHz)		Z_{source} Ω	Z_{load} Ω
1805	P1dB	$1.14 - j4.65$	$1.54 - j2.60$
1840	P1dB	$1.04 - j4.88$	$1.49 - j2.75$
1880	P1dB	$0.94 - j4.59$	$1.50 - j2.74$

Figure 13. Pulsed CW Output Power versus Input Power @ 28 V

PACKAGE DIMENSIONS

[查询"MRF8S18120H"供应商](#)

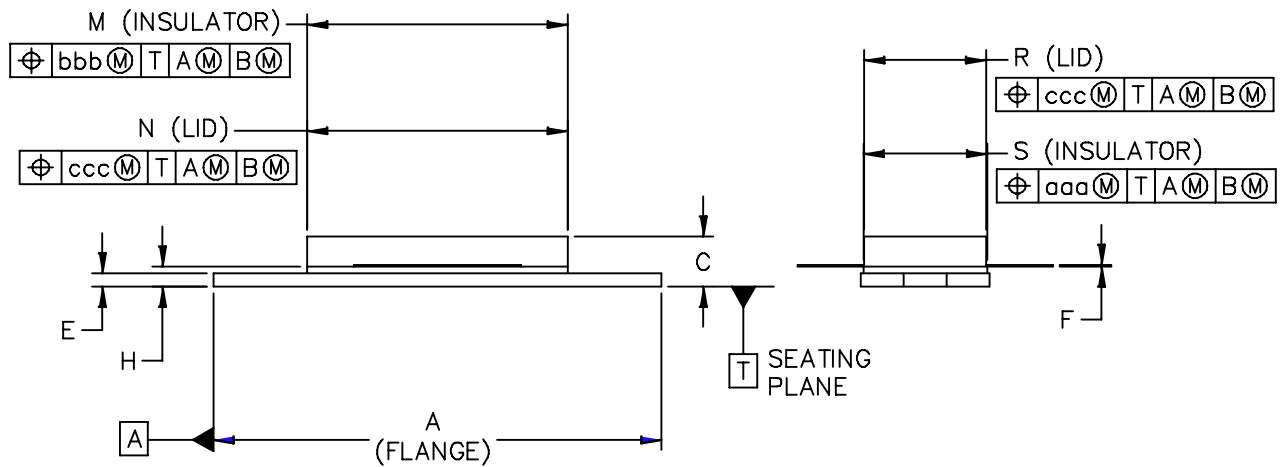
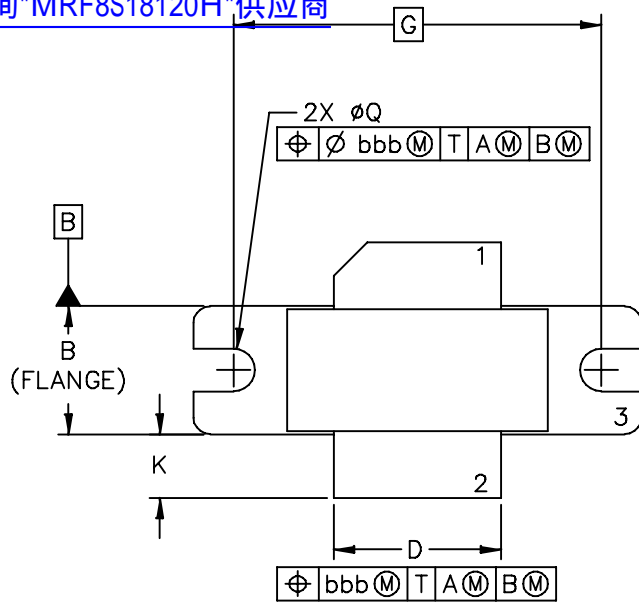

© FREESCALE SEMICONDUCTOR, INC. ALL RIGHTS RESERVED.		MECHANICAL OUTLINE		PRINT VERSION NOT TO SCALE	
TITLE: NI-780		DOCUMENT NO: 98ASB15607C		REV: G	
		CASE NUMBER: 465-06		31 MAR 2005	
		STANDARD: NON-JEDEC			

MRF8S18120HR3 MRF8S18120HSR3

NOTES:

[查询"MRF8S18120H"供应商](#)

1. DIMENSIONING AND TOLERANCING PER ANSI Y14.5M-1994.
2. CONTROLLING DIMENSION: INCH.
3. DELETED
4. DIMENSION H IS MEASURED .030 (.762) AWAY FROM PACKAGE BODY.

STYLE 1:

- PIN 1. DRAIN
 2. GATE
 3. SOURCE

DIM	INCH		MILLIMETER		DIM	INCH		MILLIMETER	
	MIN	MAX	MIN	MAX		MIN	MAX	MIN	MAX
A	1.335	– 1.345	33.91	– 34.16	R	.365	– .375	9.27	– 9.53
B	.380	– .390	9.65	– 9.91	S	.365	– .375	9.27	– 9.52
C	.125	– .170	3.18	– 4.32	aaa	– .005	–	–	0.127 –
D	.495	– .505	12.57	– 12.83	bbb	– .010	–	–	0.254 –
E	.035	– .045	0.89	– 1.14	ccc	– .015	–	–	0.381 –
F	.003	– .006	0.08	– 0.15	–	–	–	–	–
G	1.100 BSC		27.94 BSC		–	–	–	–	–
H	.057	– .067	1.45	– 1.7	–	–	–	–	–
K	.170	– .210	4.32	– 5.33	–	–	–	–	–
M	.774	– .786	19.66	– 19.96	–	–	–	–	–
N	.772	– .788	19.6	– 20	–	–	–	–	–
Q	∅.118	– ∅.138	∅3	– ∅3.51	–	–	–	–	–

© FREESCALE SEMICONDUCTOR, INC. ALL RIGHTS RESERVED.	MECHANICAL OUTLINE	PRINT VERSION NOT TO SCALE
TITLE: <div style="text-align: center; font-size: 1.2em;">NI-780</div>	DOCUMENT NO: 98ASB15607C CASE NUMBER: 465-06 STANDARD: NON-JEDEC	REV: G 31 MAR 2005

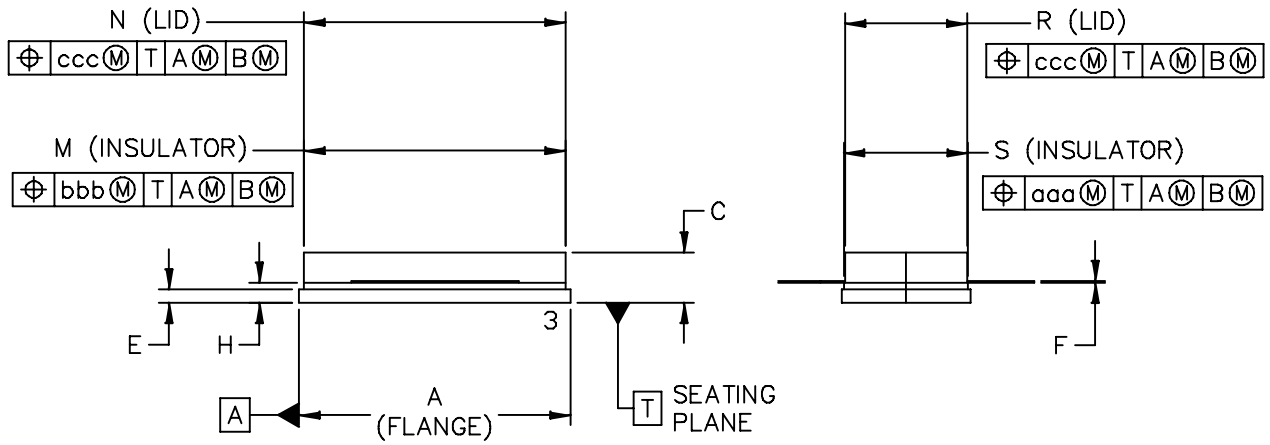
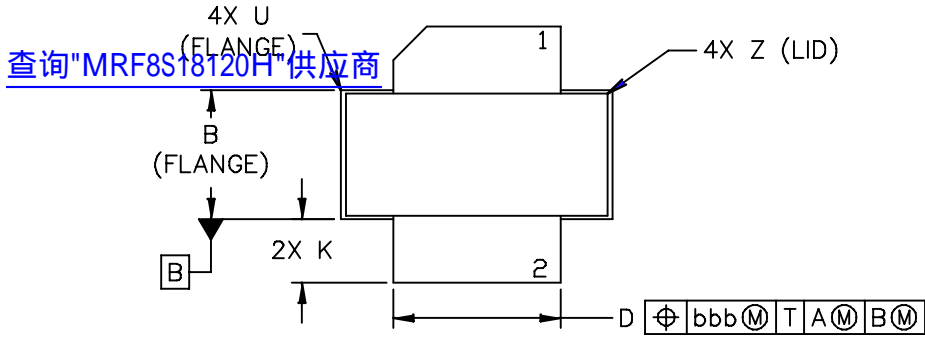

© FREESCALE SEMICONDUCTOR, INC. ALL RIGHTS RESERVED.	MECHANICAL OUTLINE	PRINT VERSION NOT TO SCALE	
TITLE: <div style="text-align: center; font-size: 1.2em;">NI-780S</div>	DOCUMENT NO: 98ASB16718C CASE NUMBER: 465A-06 STANDARD: NON-JEDEC	REV: H 31 MAR 2005	

NOTES:

[查询MRF8S18120HR3供应商](#)

1. DIMENSIONING AND TOLERANCING PER ANSI Y14.5M-1994.
2. CONTROLLING DIMENSION: INCH.
3. DELETED
4. DIMENSION H IS MEASURED .030 (0.762) AWAY FROM PACKAGE BODY.

STYLE 1:

- PIN 1. DRAIN
2. GATE
3. SOURCE

DIM	INCH		MILLIMETER		DIM	INCH		MILLIMETER	
	MIN	MAX	MIN	MAX		MIN	MAX	MIN	MAX
A	.805	-.815	20.45	- 20.7	U	-	- .040	-	- 1.02
B	.380	-.390	9.65	- 9.91	Z	-	- .030	-	- 0.76
C	.125	-.170	3.18	- 4.32	aaa	-	.005 -	-	0.127 -
D	.495	-.505	12.57	- 12.83	bbb	-	.010 -	-	0.254 -
E	.035	-.045	0.89	- 1.14	ccc	-	.015 -	-	0.381 -
F	.003	-.006	0.08	- 0.15	-	-	- -	-	- -
H	.057	-.067	1.45	- 1.7	-	-	- -	-	- -
K	.170	-.210	4.32	- 5.33	-	-	- -	-	- -
M	.774	-.786	19.61	- 20.02	-	-	- -	-	- -
N	.772	-.788	19.61	- 20.02	-	-	- -	-	- -
R	.365	-.375	9.27	- 9.53	-	-	- -	-	- -
S	.365	-.375	9.27	- 9.52	-	-	- -	-	- -

© FREESCALE SEMICONDUCTOR, INC. ALL RIGHTS RESERVED.	MECHANICAL OUTLINE	PRINT VERSION NOT TO SCALE
TITLE: <div style="text-align: center; font-size: 1.2em;">NI-780S</div>	DOCUMENT NO: 98ASB16718C CASE NUMBER: 465A-06 STANDARD: NON-JEDEC	REV: H 31 MAR 2005

PRODUCT DOCUMENTATION AND SOFTWARE

[查询"MRF8S18120H"供应商](#)

Refer to the following documents, tools and software to aid your design process.

Application Notes

- AN1955: Thermal Measurement Methodology of RF Power Amplifiers

Engineering Bulletins

- EB212: Using Data Sheet Impedances for RF LDMOS Devices

Software

- Electromigration MTTF Calculator
- RF High Power Model
- .s2p File

For Software, do a Part Number search at <http://www.freescale.com>, and select the "Part Number" link. Go to the Software & Tools tab on the part's Product Summary page to download the respective tool.

REVISION HISTORY

The following table summarizes revisions to this document.

Revision	Date	Description
0	Sept. 2009	• Initial Release of Data Sheet
1	Oct. 2010	• Changed Human Body Model ESD rating from Class 1A to Class 2 to reflect recent ESD test results of the device, p. 2

How to Reach Us:

Home Page:

www.freescale.com

Web Support:

<http://www.freescale.com/support>

USA/Europe or Locations Not Listed:

Freescale Semiconductor, Inc.
Technical Information Center, EL516
2100 East Elliot Road
Tempe, Arizona 85284
1-800-521-6274 or +1-480-768-2130
www.freescale.com/support

Europe, Middle East, and Africa:

Freescale Halbleiter Deutschland GmbH
Technical Information Center
Schatzbogen 7
81829 Muenchen, Germany
+44 1296 380 456 (English)
+46 8 52200080 (English)
+49 89 92103 559 (German)
+33 1 69 35 48 48 (French)
www.freescale.com/support

Japan:

Freescale Semiconductor Japan Ltd.
Headquarters
ARCO Tower 15F
1-8-1, Shimo-Meguro, Meguro-ku,
Tokyo 153-0064
Japan
0120 191014 or +81 3 5437 9125
support.japan@freescale.com

Asia/Pacific:

Freescale Semiconductor China Ltd.
Exchange Building 23F
No. 118 Jianguo Road
Chaoyang District
Beijing 100022
China
+86 10 5879 8000
support.asia@freescale.com

For Literature Requests Only:

Freescale Semiconductor Literature Distribution Center
1-800-441-2447 or +1-303-675-2140
Fax: +1-303-675-2150
LDCForFreescaleSemiconductor@hibbertgroup.com

Information in this document is provided solely to enable system and software implementers to use Freescale Semiconductor products. There are no express or implied copyright licenses granted hereunder to design or fabricate any integrated circuits or integrated circuits based on the information in this document.

Freescale Semiconductor reserves the right to make changes without further notice to any products herein. Freescale Semiconductor makes no warranty, representation or guarantee regarding the suitability of its products for any particular purpose, nor does Freescale Semiconductor assume any liability arising out of the application or use of any product or circuit, and specifically disclaims any and all liability, including without limitation consequential or incidental damages. "Typical" parameters that may be provided in Freescale Semiconductor data sheets and/or specifications can and do vary in different applications and actual performance may vary over time. All operating parameters, including "Typicals", must be validated for each customer application by customer's technical experts. Freescale Semiconductor does not convey any license under its patent rights nor the rights of others. Freescale Semiconductor products are not designed, intended, or authorized for use as components in systems intended for surgical implant into the body, or other applications intended to support or sustain life, or for any other application in which the failure of the Freescale Semiconductor product could create a situation where personal injury or death may occur. Should Buyer purchase or use Freescale Semiconductor products for any such unintended or unauthorized application, Buyer shall indemnify and hold Freescale Semiconductor and its officers, employees, subsidiaries, affiliates, and distributors harmless against all claims, costs, damages, and expenses, and reasonable attorney fees arising out of, directly or indirectly, any claim of personal injury or death associated with such unintended or unauthorized use, even if such claim alleges that Freescale Semiconductor was negligent regarding the design or manufacture of the part.

Freescale™ and the Freescale logo are trademarks of Freescale Semiconductor, Inc. All other product or service names are the property of their respective owners.

© Freescale Semiconductor, Inc. 2009-2010. All rights reserved.

