

FEATURES AND SPECIFICATIONS

[查询"39100-1004"供应商](#)

Eurostyle Two-Screw Terminal Strips are available in a wide variety of pitch spacings

The Eurostyle Two-Screw Terminal Strips from Molex allow customers to pick from a variety of pitch sizes in either a standard or low-profile version, to ensure the best fit for their design requirements. The low-profile blocks are rated at 300V, while the standard-profile blocks are rated at 600V. Amperages range from 20.0 to 63.0A depending on the particular pitch space chosen.

All Two-Screw terminal strips meet applicable industry standards and have a flammability rating of UL 94V-2. In addition, they are designed with wire protectors to prevent wire damage and to ensure a reliable connection. Pre-drilled mounting holes allow for quick and easy installation in the field. Two and three circuit jumpers are also available.

Features and Benefits

- Modular design allows larger blocks to be easily cut into smaller circuit sizes
- Contacts and screws are recessed within the housing to help prevent short circuits
- Wire protectors prevent stranded wire damage during connection
- Range of pitch spacing, wire ranges and electrical ratings provides the customer with design flexibility to choose the block that best fits the requirements
- Easy installation saves time and money

Virtually any terminal strip requirement can be met with the variety of Eurostyle Two-Screw Terminal Strip styles offered.



8.00mm (.315") Pitch
10.00mm (.394") Pitch
12.00mm (.472") Pitch
15.00mm (.591") Pitch
Eurostyle® Two-Screw Terminal Strip

39100



SPECIFICATIONS

Reference Information

UL File No.: E48521
Guide No.: XCFR2
CSA: 025562

Electrical

Voltage:
39100-08XX, -09XX, -10XX, -11XX, -13XX: 300V
39100-12XX, -15XX: 600V

Current:
39100-08XX, -09XX: 20.0A
39100-10XX, -11XX: 30.0A
39100-12XX, -13XX: 40.0A
39100-15XX: 63.0A

Contact Resistance: 0.1 milliohms
Insulation Resistance: 5,000 Megohms min.

Mechanical

Recommended Tightening Torque:
39100-08XX, -09XX: 0.5Nm (4.4 in.-lbs.)
39100-10XX, -11XX, -12XX, -13XX:
0.8Nm (7.0 in.-lbs.)
39100-15XX: 2.1Nm (18.5 in.-lbs.)

UL Flammability Rating: UL 94V-2

Wire Range:
39100-08XX, -09XX: 12 to 22 AWG
39100-10XX, -11XX: 10 to 18 AWG
39100-12XX, -13XX: 8 to 20 AWG
39100-15XX: 6 to 14 AWG

Insulation Temperature Resistance:
Continuous — +100°C
Short Term — +140°C

Physical

Housing: Nylon, Polyamide 6/6
Terminal: Brass
Wire Protector: Stainless Steel
Screw: Steel
Plating:
Terminal — Nickel
Screw — Zinc



APPLICATIONS



[查询"39100-1004"供应商](#)

- Power supplies
- Spa controllers
- HVAC equipment
- Motor controls
- Lighting controls

8.00mm (.315") Pitch
10.00mm (.394") Pitch
12.00mm (.472") Pitch
15.00mm (.591") Pitch
Eurostyle® Two-Screw
Terminal Strip

39100

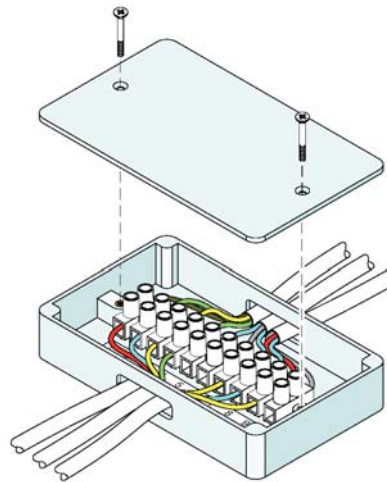

Junction Box

ORDERING INFORMATION

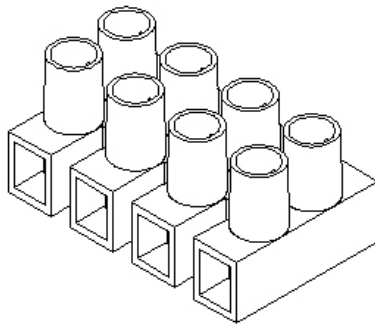

Low-Profile Terminal Strip

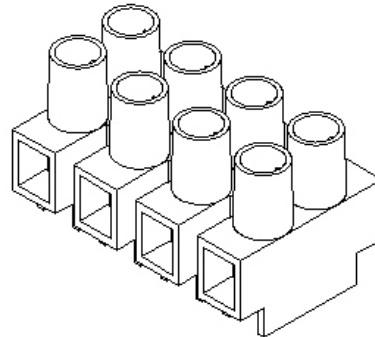

Standard-Profile Terminal Strip

Circuits	Order No.						
	8.00mm (.315") Pitch		10.00mm (.394") Pitch		12.00mm (.472") Pitch		15.00mm (.591") Pitch
	Low-Profile without Standoffs	Standard-Profile with Standoffs	Low-Profile without Standoffs	Standard-Profile with Standoffs	Low-Profile without Standoffs	Standard-Profile with Standoffs	Standard-Profile with Standoffs
2	39100-0902	39100-0802	39100-1102	39100-1002	39100-1302	39100-1202	39100-1502
3	39100-0903	39100-0803	39100-1103	39100-1003	39100-1303	39100-1203	39100-1503
4	39100-0904	39100-0804	39100-1104	39100-1004	39100-1304	39100-1204	39100-1504
5	39100-0905	39100-0805	39100-1105	39100-1005	39100-1305	39100-1205	39100-1505
6	39100-0906	39100-0806	39100-1106	39100-1006	39100-1306	39100-1206	39100-1506
7	39100-0907	39100-0807	39100-1107	39100-1007	39100-1307	39100-1207	39100-1507
8	39100-0908	39100-0808	39100-1108	39100-1008	39100-1308	39100-1208	39100-1508
9	39100-0909	39100-0809	39100-1109	39100-1009	39100-1309	39100-1209	39100-1509
10	39100-0910	39100-0810	39100-1110	39100-1010	39100-1310	39100-1210	39100-1510
11	39100-0911	39100-0811	39100-1111	39100-1011	39100-1311	39100-1211	39100-1511
12	39100-0912	39100-0812	39100-1112	39100-1012	39100-1312	39100-1212	39100-1512
Jumper Circuits							
Circuits	8.00mm (.315") Pitch		10.00mm (.394") Pitch		12.00mm (.472") Pitch		15.00mm (.591") Pitch
2	38002-1730		38002-1732		38002-1734		38002-1736
3	38002-1731		38002-1733		38002-1735		N/A

Americas Headquarters
 Lisle, Illinois 60532 U.S.A.
 1-800-78MOLEX
 amerinfo@molex.com

Far East North Headquarters
 Yamato, Kanagawa, Japan
 81-462-65-2324
 feninfo@molex.com

Far East South Headquarters
 Jurong, Singapore
 65-6-268-6868
 fesinfo@molex.com

European Headquarters
 Munich, Germany
 49-89-413092-0
 eurinfo@molex.com

Corporate Headquarters
 2222 Wellington Ct.
 Lisle, IL 60532 U.S.A.
 630-969-4550
 Fax:630-969-1352

Visit our Web site at <http://www.molex.com/product/tblocks.html>