

TLV341, TLV342, TLV342S, TLV344 LOW-VOLTAGE RAIL-TO-RAIL OUTPUT CMOS OPERATIONAL AMPLIFIERS WITH SHUTDOWN

查询"TLV341"供应商

SLVS568C – JANUARY 2005 – REVISED NOVEMBER 2007

- 1.8-V and 5-V Performance
- Low Offset (A Grade)
 - 1.25 mV Max (25°C)
 - 1.7 mV Max (–40°C to 125°C)
- Rail-to-Rail Output Swing
- Wide Common-Mode Input Voltage Range . . . –0.2 V to (V₊ – 0.5 V)
- Input Bias Current . . . 1 pA (Typ)
- Input Offset Voltage . . . 0.3 mV (Typ)
- Low Supply Current . . . 70 µA/Channel
- Low Shutdown Current . . . 10 pA (Typ) Per Channel
- Gain Bandwidth . . . 2.3 MHz (Typ)
- Slew Rate . . . 0.9 V/µs (Typ)
- Turn-On Time From Shutdown . . . 5 µs (Typ)
- Input Referred Voltage Noise (at 10 kHz) . . . 20 nV/√Hz
- ESD Protection Exceeds JESD 22
 - 2000-V Human-Body Model (A114-A)
 - 200-V Machine Model (A115-A)
- Applications
 - Cordless/Cellular Phones
 - Consumer Electronics (Laptops, PDAs)
 - Audio Pre-Amp for Voice
 - Portable/Battery-Powered Electronic Equipment
 - Supply Current Monitoring
 - Battery Monitoring
 - Buffers
 - Filters
 - Drivers

TLV341
DBV (SOT-23) OR DCK (SC-70) PACKAGE
(TOP VIEW)

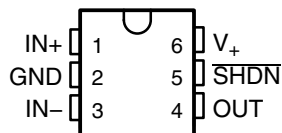

TLV341
DRL (SOT-563) PACKAGE
(TOP VIEW)

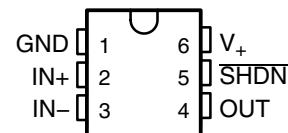

TLV342
D (SOIC) OR DGK (MSOP) PACKAGE
(TOP VIEW)

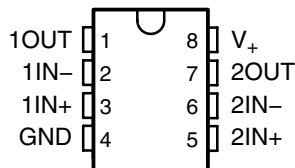

TLV342
RUG (QFN) PACKAGE
(TOP VIEW)

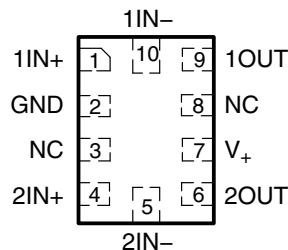

NC – No internal connection

TLV342S
RUG (QFN) PACKAGE
(TOP VIEW)

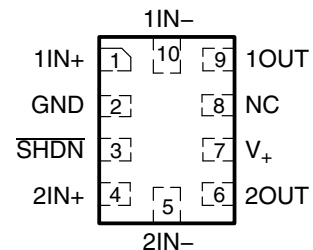

NC – No internal connection

TLV344
D (SOIC) OR PW (TSSOP) PACKAGE
(TOP VIEW)

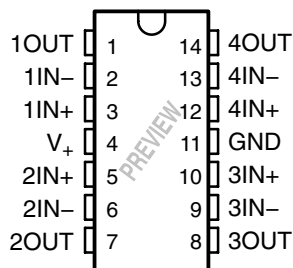

Please be aware that an important notice concerning availability, standard warranty, and use in critical applications of Texas Instruments semiconductor products and disclaimers thereto appears at the end of this data sheet.

PRODUCTION DATA information is current as of publication date. Products conform to specifications per the terms of Texas Instruments standard warranty. Production processing does not necessarily include testing of all parameters.



POST OFFICE BOX 655303 • DALLAS, TEXAS 75265

Copyright © 2007, Texas Instruments Incorporated

TLV341, TLV342, TLV342S, TLV344 LOW-VOLTAGE RAIL-TO-RAIL OUTPUT CMOS OPERATIONAL AMPLIFIERS WITH SHUTDOWN

SLV342C JANUARY 2006 REVISED NOVEMBER 2007

查询 TLV342 供应商

description/ordering information

The TLV341, TLV342, and TLV344 are single, dual, and quad CMOS operational amplifiers, respectively, with low-voltage, low-power, and rail-to-rail output swing capabilities. The PMOS input stage offers an ultra-low input bias current of 1 pA (typ) and an offset voltage of 0.3 mV (typ). For applications requiring excellent dc precision, the A grade (TLV34xA) has a low offset voltage of 1.25 mV (max) at 25°C.

These single-supply amplifiers are designed specifically for ultra-low-voltage (1.5-V to 5-V) operation, with a common-mode input voltage range that typically extends from -0.2 V to 0.5 V from the positive supply rail. Additional features include 20-nV/ $\sqrt{\text{Hz}}$ voltage noise at 10 kHz, 2.3-MHz unity-gain bandwidth, and 0.9-V/ μs slew rate.

The TLV341 (single) and TLV342 (dual) in the RUG package also offer a shutdown ($\overline{\text{SHDN}}$) pin that can be used to disable the device. In shutdown mode, the supply current is reduced to 45 pA (typ). Offered in both the SOT-23 and smaller SC-70 packages, the TLV341 is suitable for the most space-constrained applications. The dual TLV342 is offered in the standard SOIC, MSOP, and QFN packages.

An extended industrial temperature range from -40°C to 125°C makes the TLV34x suitable in a wide variety of commercial and industrial applications.



POST OFFICE BOX 655303 • DALLAS, TEXAS 75265

TLV341, TLV342, TLV342S, TLV344 LOW-VOLTAGE RAIL-TO-RAIL OUTPUT CMOS OPERATIONAL AMPLIFIERS WITH SHUTDOWN

[查询"TLV341"供应商](#)

SLVS568C – JANUARY 2005 – REVISED NOVEMBER 2007

ORDERING INFORMATION†

T _A	MAX V _{IO} (25°C)	PACKAGE‡		ORDERABLE PART NUMBER	TOP-SIDE MARKING§		
-40°C to 125°C	Standard grade: 4 mV	Single	SOT-23 – DBV	Reel of 3000	TLV341IDBVR	YC9_	
				Reel of 250	TLV341IDBVT		
			SC-70 – DCK	Reel of 3000	TLV341IDCKR	Y4_	
				Reel of 250	TLV341IDCKT		
			SOT-563 – DRL	Reel of 4000	TLV341IDRLR	Y4_	
			Dual	QFN – RUG	Reel of 3000	TLV342IRUGR	Y6E
		Reel of 3000			TLV342SIRUGR	2YE	
		SOIC – D		Tube of 75	TLV342ID	TY342	
				Reel of 2500	TLV342IDR		
		MSOP/VSSOP – DGK		Reel of 2500	TLV342IDGKR	PREVIEW	
				Reel of 250	TLV342IDGKT		
		Quad	SOIC – D	Tube of 50	TLV344ID	PREVIEW	
				Reel of 2500	TLV344IDR		
			TSSOP – PW	Tube of 90	TLV344IPWR	PREVIEW	
				Reel of 2000	TLV344IPWR		
		A grade: 1.25 mV	Single	SOT-23 – DBV	Reel of 3000	TLV341AIDBVR	YCG_
					Reel of 250	TLV341AIDBVT	
				SC-70 – DCK	Reel of 3000	TLV341AIDCKR	Y5_
	Reel of 250				TLV341AIDCKT		
	Dual			SOIC – D	Tube of 75	TLV342AID	TY342A
					Reel of 2500	TLV342AIDR	
			MSOP/VSSOP – DGK	Reel of 2500	TLV342AIDGKR	PREVIEW	
				Reel of 250	TLV342AIDGKT		
	Quad		SOIC – D	Tube of 50	TLV344AID	PREVIEW	
Reel of 2500				TLV344AIDR			
TSSOP – PW			Tube of 90	TLV344AIPWR	PREVIEW		
			Reel of 2000	TLV344AIPWR			

† For the most current package and ordering information, see the Package Option Addendum at the end of this document, or see the TI web site at www.ti.com.

‡ Package drawings, thermal data, and symbolization are available at www.ti.com/packaging.

§ DBV/DCK/DRL: The actual top-side marking has one additional character that designates the wafer fab/assembly site.



TLV341, TLV342, TLV342S, TLV344 LOW-VOLTAGE RAIL-TO-RAIL OUTPUT CMOS OPERATIONAL AMPLIFIERS WITH SHUTDOWN

SLVS383C JANUARY 2006 修订 NOVEMBER 2007
[查看 TLV341 供应商](#)

symbol (each amplifier)

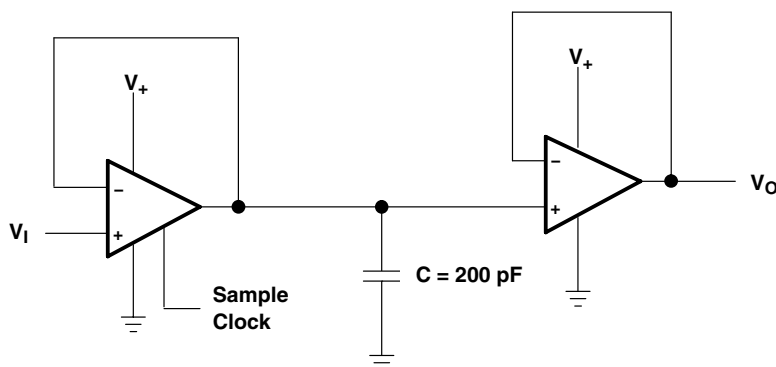

absolute maximum ratings over operating free-air temperature range (unless otherwise noted)†

Supply voltage, V_+ (see Note 1)	5.5 V
Differential input voltage, V_{ID} (see Note 2)	± 5.5 V
Input voltage range, V_I (either input)	0 to 5.5 V
Package thermal impedance, θ_{JA} (see Notes 3 and 4):	
D package (8 pin)	97°C/W
D package (14 pin)	86°C/W
DBV package	165°C/W
DCK package	259°C/W
DGK package	172°C/W
DRL package	142°C/W
PW package	113°C/W
RUG package	243°C/W
Operating virtual junction temperature	150°C
Storage temperature range, T_{stg}	-65°C to 150°C

† Stresses beyond those listed under “absolute maximum ratings” may cause permanent damage to the device. These are stress ratings only, and functional operation of the device at these or any other conditions beyond those indicated under “recommended operating conditions” is not implied. Exposure to absolute-maximum-rated conditions for extended periods may affect device reliability.

- NOTES:
1. All voltage values (except differential voltages and V_+ specified for the measurement of I_{OS}) are with respect to the network GND.
 2. Differential voltages are at $IN+$ with respect to $IN-$.
 3. Maximum power dissipation is a function of $T_J(\max)$, θ_{JA} , and T_A . The maximum allowable power dissipation at any allowable ambient temperature is $P_D = (T_J(\max) - T_A)/\theta_{JA}$. Selecting the maximum of 150°C can affect reliability.
 4. The package thermal impedance is calculated in accordance with JESD 51-7.

recommended operating conditions

	MIN	MAX	UNIT
V_+ Supply voltage (single-supply operation)	1.5	5.5	V
T_A Operating free-air temperature	-40	125	°C

ESD protection

TEST CONDITIONS	TYP	UNIT
Human-Body Model	2000	V
Machine Model	200	V



TLV341, TLV342, TLV342S, TLV344 LOW-VOLTAGE RAIL-TO-RAIL OUTPUT CMOS OPERATIONAL AMPLIFIERS WITH SHUTDOWN

[查询"TLV341"供应商](#)

SLVS568C – JANUARY 2005 – REVISED NOVEMBER 2007

electrical characteristics, $V_+ = 1.8\text{ V}$, $GND = 0$, $V_{IC} = V_O = V_+/2$, $R_L > 1\text{ M}\Omega$ (unless otherwise noted)

PARAMETER		TEST CONDITIONS		T_A	MIN	TYP†	MAX	UNIT	
V_{IO}	Input offset voltage	Standard grade		25°C	0.3		4	mV	
				Full range					4.5
		A grade		25°C	0.3		1.25		
				0°C to 125°C		0.3			1.5
				-40°C to 125°C		0.3			1.7
$\alpha_{V_{IO}}$	Average temperature coefficient of input offset voltage			Full range	1.9		$\mu\text{V}/^\circ\text{C}$		
I_{IB}	Input bias current			25°C	1		100	pA	
				-40°C to 85°C			375		
				-40°C to 125°C			3000		
I_{IO}	Input offset current			25°C	6.6		fA		
CMRR	Common-mode rejection ratio	$0 \leq V_{ICR} \leq 1.2\text{ V}$		25°C	60	85		dB	
				Full range			50		
k_{SVR}	Supply-voltage rejection ratio	$1.8\text{ V} \leq V_+ \leq 5\text{ V}$		25°C	75	95		dB	
				Full range			65		
V_{ICR}	Common-mode input voltage range	CMRR $\geq 60\text{ dB}$		25°C	0		1.2	V	
A_V	Large-signal voltage gain (see Note 5)	$R_L = 10\text{ k}\Omega$ to 1.35 V		25°C	70	110		dB	
				Full range			60		
		$R_L = 2\text{ k}\Omega$ to 1.35 V		25°C	65	100			
				Full range			55		
V_O	Output swing (delta from supply rails)	$R_L = 2\text{ k}\Omega$ to 0.9 V		Low level	25°C	22	50	mV	
				High level	25°C	25	50		
				Full range			75		
				Full range			75		
		$R_L = 10\text{ k}\Omega$ to 0.9 V		Low level	25°C	14	20		
				High level	25°C	7	20		
				Full range			25		
				Full range			25		
I_{CC}	Supply current (per channel)			25°C	70	150	μA		
				Full range				200	
I_{OS}	Output short-circuit current	Sourcing		25°C	6	12	mA		
		Sinking			10	20			
SR	Slew rate	$R_L = 10\text{ k}\Omega$, Note 6		25°C	0.9		V/ μs		
GBW	Unity-gain bandwidth	$R_L = 100\text{ k}\Omega$, $C_L = 200\text{ pF}$		25°C	2.2		MHz		
Φ_m	Phase margin	$R_L = 100\text{ k}\Omega$, $C_L = 20\text{ pF}$		25°C	55		°		
G_m	Gain margin	$R_L = 100\text{ k}\Omega$, $C_L = 20\text{ pF}$		25°C	15		dB		
V_n	Equivalent input noise voltage	$f = 1\text{ kHz}$		25°C	33		nV/ $\sqrt{\text{Hz}}$		
I_n	Equivalent input noise current	$f = 1\text{ kHz}$		25°C	0.001		pA/ $\sqrt{\text{Hz}}$		
THD	Total harmonic distortion	$f = 1\text{ kHz}$, $A_V = 1$, $R_L = 600\ \Omega$, $V_I = 1\text{ V}_{PP}$		25°C	0.015		%		

† Typical values represent the most likely parametric norm.

NOTES: 5. $GND + 0.2\text{ V} \leq V_O \leq V_{CC+} - 0.2\text{ V}$

6. Connected as voltage follower with 1.1- V_{PP} step input. Number specified is the slower of the positive and negative slew rates.



TLV341, TLV342, TLV342S, TLV344

LOW-VOLTAGE RAIL-TO-RAIL OUTPUT CMOS OPERATIONAL AMPLIFIERS WITH SHUTDOWN

SLV588C JANUARY 2006 REVISED NOVEMBER 2007

[查询TLV341供应商](#)

shutdown characteristics, $V_+ = 1.8\text{ V}$, $\text{GND} = 0$, $V_{\text{IC}} = V_{\text{O}} = V_+/2$, $R_{\text{L}} > 1\text{ M}\Omega$ (unless otherwise noted)

PARAMETER		TEST CONDITIONS	T_{A}	MIN	TYP	MAX	UNIT
$I_{\text{CC(SHDN)}}$	Supply current in shutdown mode (per channel)	$V_{\text{SD}} = 0\text{ V}$	25°C		0.01	1	μA
			Full range			1.5	μA
$t_{\text{(on)}}$	Amplifier turn-on time		25°C		5		μs
V_{SD}	Shutdown pin voltage range	ON mode	25°C	1.5		1.8	V
		Shutdown mode		0		0.5	

TLV341, TLV342, TLV342S, TLV344 LOW-VOLTAGE RAIL-TO-RAIL OUTPUT CMOS OPERATIONAL AMPLIFIERS WITH SHUTDOWN

查询"TLV341"供应商

SLVS568C – JANUARY 2005 – REVISED NOVEMBER 2007

electrical characteristics, $V_+ = 5\text{ V}$, $\text{GND} = 0$, $V_{\text{IC}} = V_{\text{O}} = V_+/2$, $R_{\text{L}} > 1\text{ M}\Omega$ (unless otherwise noted)

PARAMETER	TEST CONDITIONS		T_{A}	MIN	TYP†	MAX	UNIT
V_{IO} Input offset voltage	Standard grade		25°C	0.3	0.3	4	mV
			Full range		4.5		
	A grade		25°C	0.3	0.3	1.25	
			0°C to 125°C		0.3	1.5	
			-40°C to 125°C		0.3	1.7	
$\alpha_{V_{\text{IO}}}$ Average temperature coefficient of input offset voltage			Full range	1.9		$\mu\text{V}/^\circ\text{C}$	
I_{IB} Input bias current			25°C	1	1	200	pA
			-40°C to 85°C		375		
			-40°C to 125°C		3000		
I_{IO} Input offset current			25°C	6.6		fA	
CMRR Common-mode rejection ratio	$0 \leq V_{\text{ICR}} \leq 4.4\text{ V}$		25°C	75	75	90	dB
			Full range		70		
k_{SVR} Supply-voltage rejection ratio	$1.8\text{ V} \leq V_+ \leq 5\text{ V}$		25°C	75	75	95	dB
			Full range		65		
V_{ICR} Common-mode input voltage range	CMRR $\geq 70\text{ dB}$		25°C	0	-0.2 to 4.5	4.4	V
A_{V} Large-signal voltage gain (see Note 5)	$R_{\text{L}} = 10\text{ k}\Omega$ to 2.5 V		25°C	80	80	110	dB
			Full range		70		
	$R_{\text{L}} = 2\text{ k}\Omega$ to 2.5 V		25°C	75	75	105	
			Full range		60		
V_{O} Output swing (delta from supply voltage)	$R_{\text{L}} = 2\text{ k}\Omega$ to 2.5 V	Low level	25°C	40	40	60	mV
			Full range		85		
		High level	25°C	25	25	60	
			Full range		85		
	$R_{\text{L}} = 10\text{ k}\Omega$ to 2.5 V	Low level	25°C	18	18	30	
			Full range		40		
		High level	25°C	7	7	15	
			Full range		20		
I_{CC} Supply current (per channel)			25°C	75	75	150	μA
			Full range		200		
I_{OS} Output short-circuit current	Sourcing		25°C	60	60	113	mA
	Sinking			80	80	115	
SR Slew rate	$R_{\text{L}} = 10\text{ k}\Omega$, Note 6		25°C	1	1	$\text{V}/\mu\text{s}$	
GBW Unity-gain bandwidth	$R_{\text{L}} = 10\text{ k}\Omega$, $C_{\text{L}} = 200\text{ pF}$		25°C	2.3	2.3	MHz	
Φ_{m} Phase margin	$R_{\text{L}} = 100\text{ k}\Omega$, $C_{\text{L}} = 20\text{ pF}$		25°C	55	55	$^\circ$	
G_{m} Gain margin	$R_{\text{L}} = 100\text{ k}\Omega$, $C_{\text{L}} = 20\text{ pF}$		25°C	15	15	dB	
V_{n} Equivalent input noise voltage	$f = 1\text{ kHz}$		25°C	33	33	$\text{nV}/\sqrt{\text{Hz}}$	
I_{n} Equivalent input noise current	$f = 1\text{ kHz}$		25°C	0.001	0.001	$\text{pA}/\sqrt{\text{Hz}}$	
THD Total harmonic distortion	$f = 1\text{ kHz}$, $A_{\text{V}} = 1$, $R_{\text{L}} = 600\ \Omega$, $V_{\text{I}} = 1\text{ V}_{\text{PP}}$		25°C	0.012	0.012	%	

† Typical values represent the most likely parametric norm.

NOTES: 5. $\text{GND} + 0.2\text{ V} \leq V_{\text{O}} \leq V_{\text{CC}+} - 0.2\text{ V}$

6. Connected as voltage follower with 2- V_{PP} step input. Number specified is the slower of the positive and negative slew rates.



TLV341, TLV342, TLV342S, TLV344

LOW-VOLTAGE RAIL-TO-RAIL OUTPUT CMOS OPERATIONAL AMPLIFIERS WITH SHUTDOWN

SLV588C JANUARY 2006 REVISED NOVEMBER 2007

[查询 TLV341 供应商](#)

shutdown characteristics, $V_+ = 5\text{ V}$, $\text{GND} = 0$, $V_{\text{IC}} = V_{\text{O}} = V_+/2$, $R_{\text{L}} > 1\text{ M}\Omega$ (unless otherwise noted)

PARAMETER		TEST CONDITIONS	T_{A}	MIN	TYP	MAX	UNIT
$I_{\text{CC}}(\text{SHDN})$	Supply current in shutdown mode (per channel)	$V_{\text{SD}} = 0\text{ V}$	25°C		0.01	1	μA
			Full range			1.5	
$t_{(\text{on})}$	Amplifier turn-on time		25°C		5		μs
V_{SD}	Shutdown pin voltage range	ON mode	25°C	4.5		5	V
		Shutdown mode		0		0.8	

TLV341, TLV342, TLV342S, TLV344 LOW-VOLTAGE RAIL-TO-RAIL OUTPUT CMOS OPERATIONAL AMPLIFIERS WITH SHUTDOWN

查询"TLV341"供应商

SLVS568C – JANUARY 2005 – REVISED NOVEMBER 2007

TYPICAL CHARACTERISTICS

**SUPPLY CURRENT
vs
SUPPLY VOLTAGE**

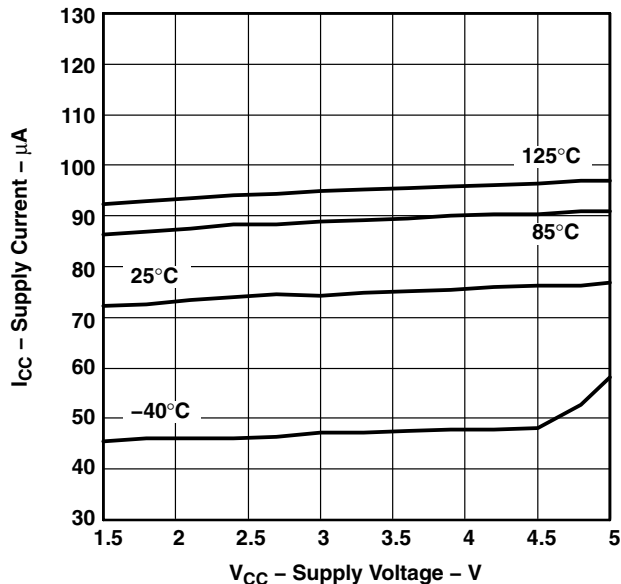

Figure 1

**INPUT BIAS CURRENT
vs
TEMPERATURE**

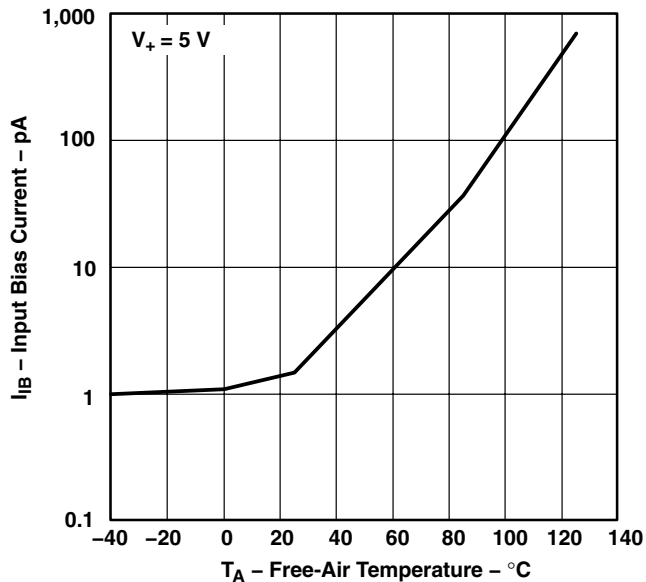

Figure 2

**OUTPUT VOLTAGE SWING
vs
SUPPLY VOLTAGE**

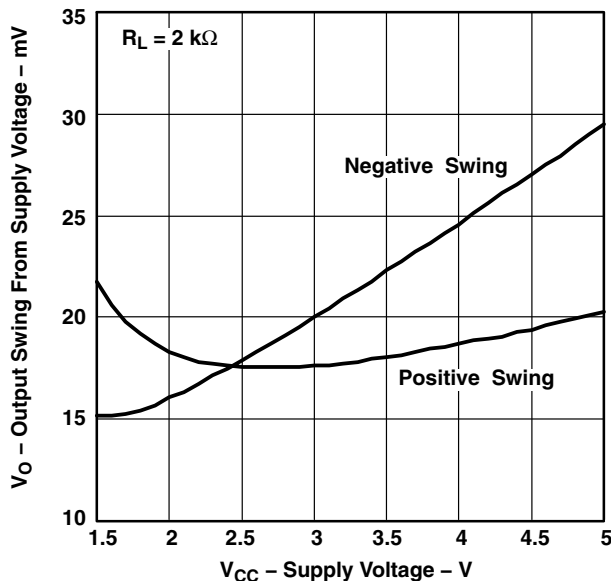

Figure 3

**OUTPUT VOLTAGE SWING
vs
SUPPLY VOLTAGE**

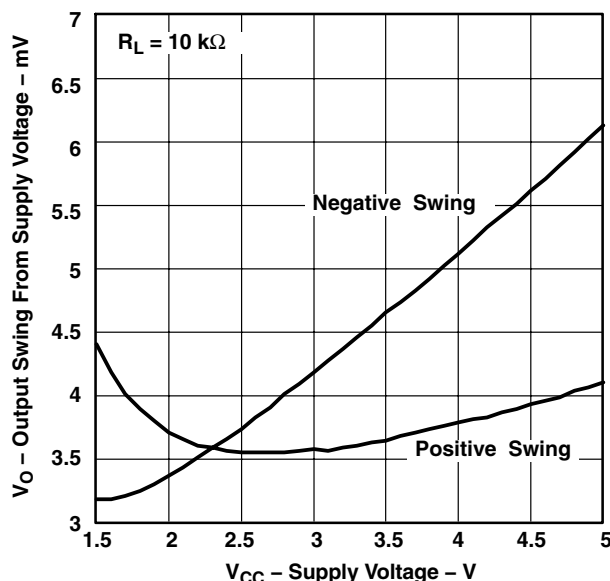

Figure 4

TLV341, TLV342, TLV342S, TLV344 LOW-VOLTAGE RAIL-TO-RAIL OUTPUT CMOS OPERATIONAL AMPLIFIERS WITH SHUTDOWN

SLVSB83C JANUARY 2006 重新修订 NOVEMBER 2007
德州仪器 TLV341 供应商

TYPICAL CHARACTERISTICS

**SOURCE CURRENT
vs
OUTPUT VOLTAGE**

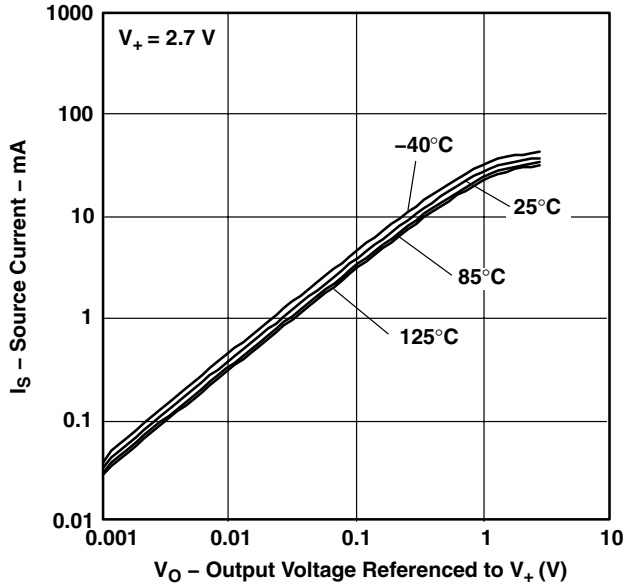

Figure 5

**SOURCE CURRENT
vs
OUTPUT VOLTAGE**

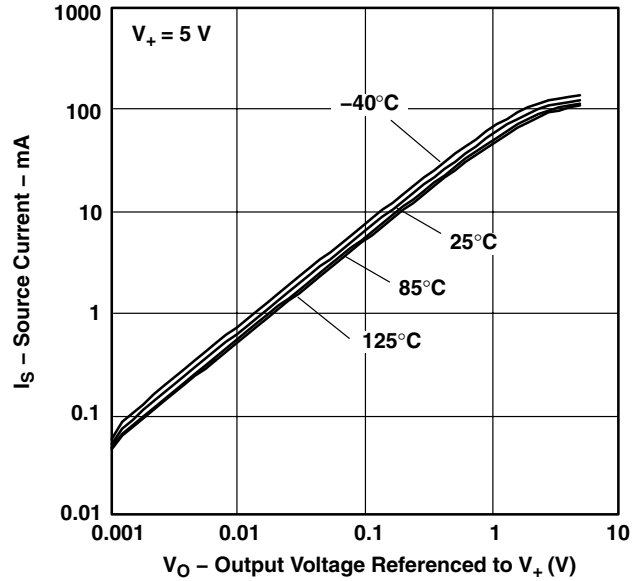

Figure 6

**SINK CURRENT
vs
OUTPUT VOLTAGE**

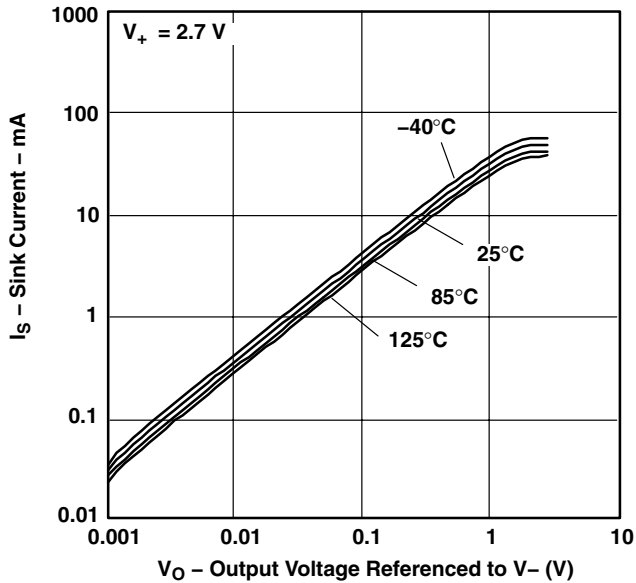

Figure 7

**SINK CURRENT
vs
OUTPUT VOLTAGE**

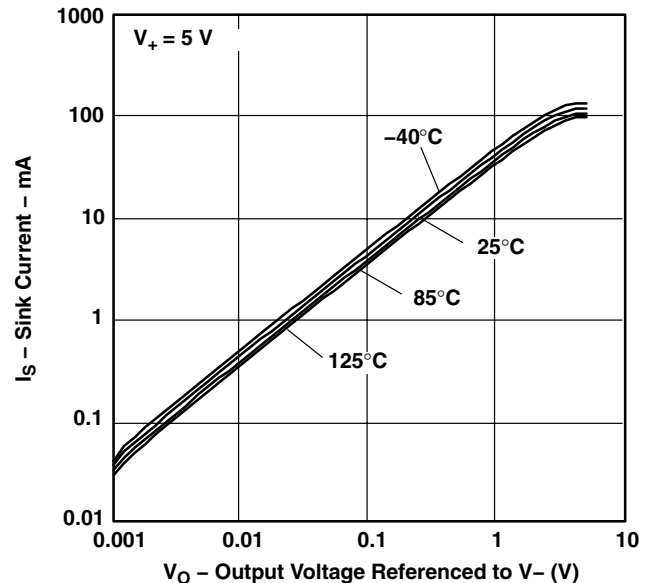

Figure 8

TLV341, TLV342, TLV342S, TLV344 LOW-VOLTAGE RAIL-TO-RAIL OUTPUT CMOS OPERATIONAL AMPLIFIERS WITH SHUTDOWN

[查询"TLV341"供应商](#)

SLVS568C – JANUARY 2005 – REVISED NOVEMBER 2007

TYPICAL CHARACTERISTICS

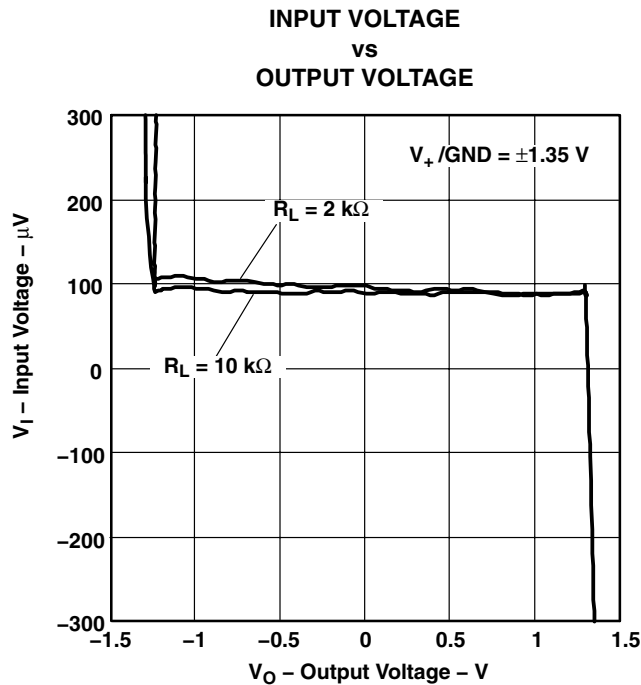
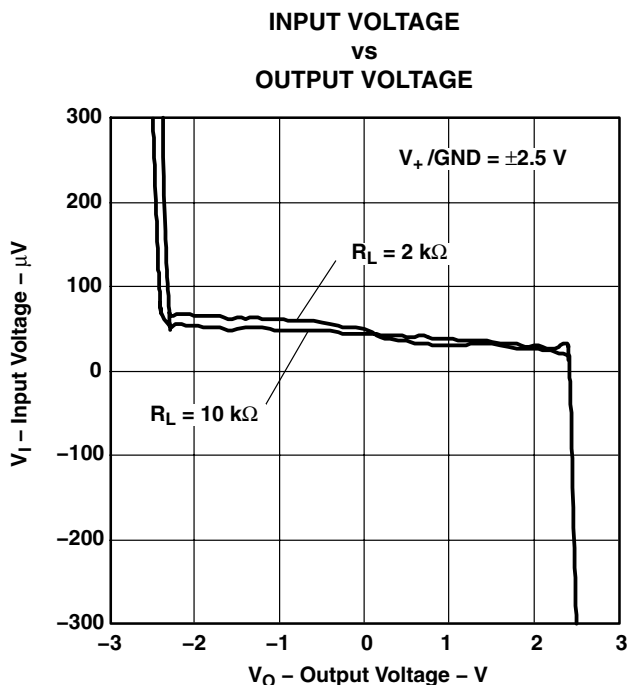
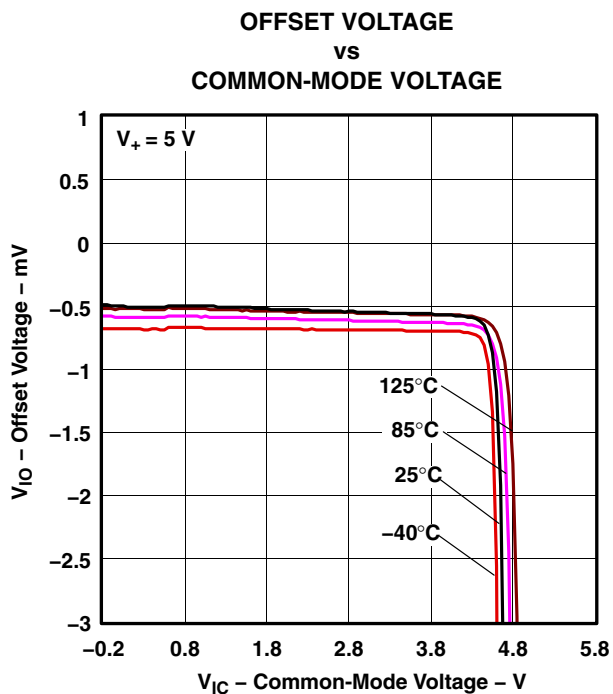
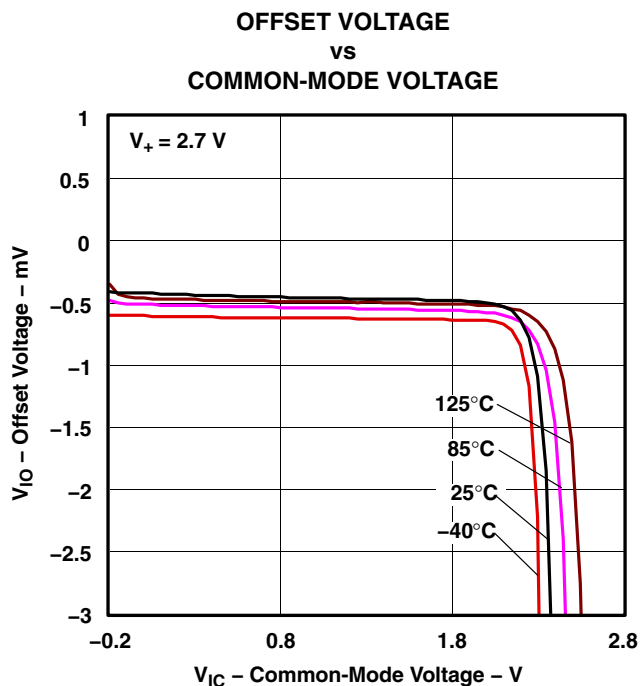

TLV341, TLV342, TLV342S, TLV344 LOW-VOLTAGE RAIL-TO-RAIL OUTPUT CMOS OPERATIONAL AMPLIFIERS WITH SHUTDOWN

SLVSB83C JANUARY 2006 提供商 REVISED NOVEMBER 2007

TYPICAL CHARACTERISTICS

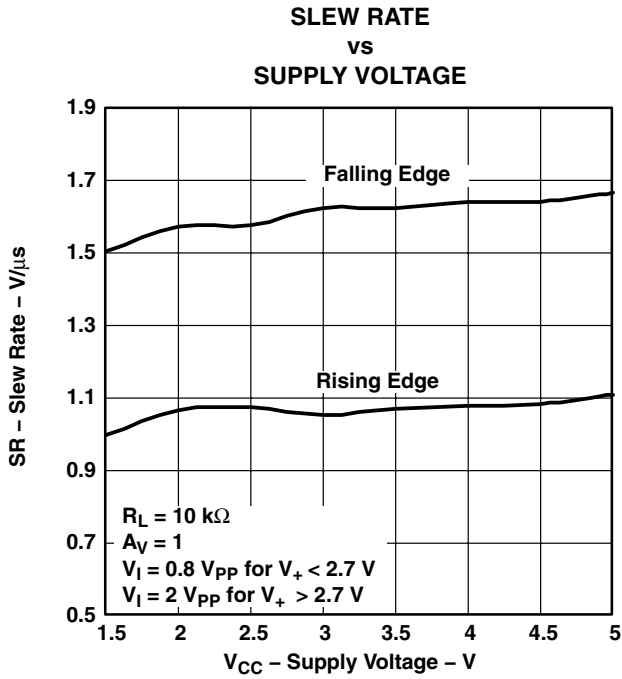

Figure 13

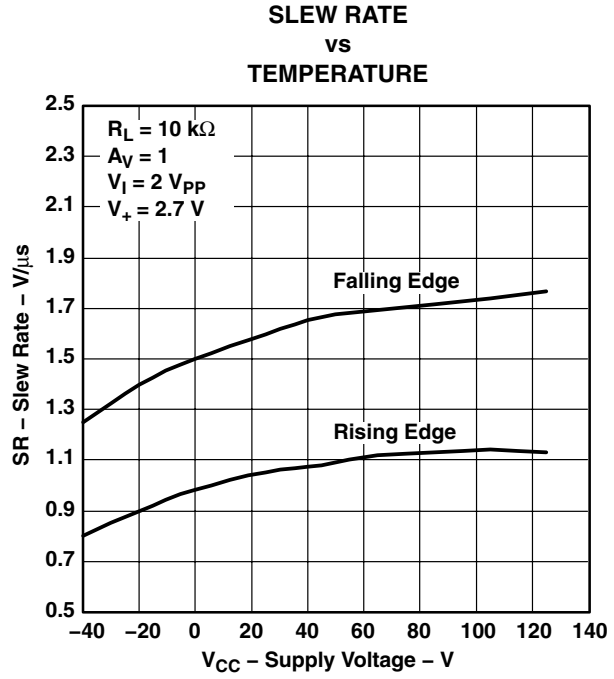

Figure 14

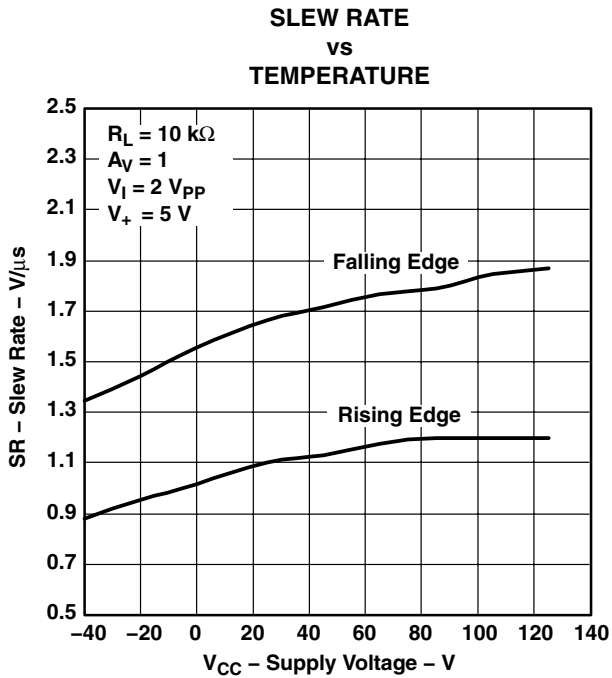

Figure 15

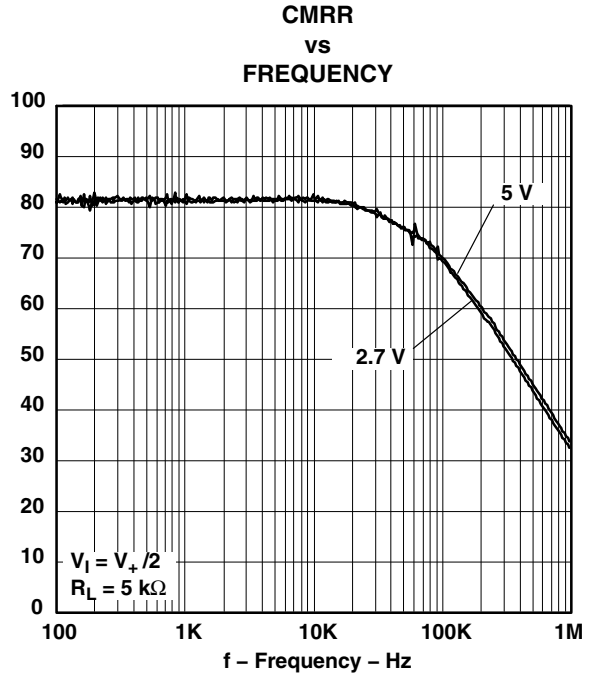

Figure 16

TLV341, TLV342, TLV342S, TLV344 LOW-VOLTAGE RAIL-TO-RAIL OUTPUT CMOS OPERATIONAL AMPLIFIERS WITH SHUTDOWN

查询"TLV341"供应商

SLVS568C – JANUARY 2005 – REVISED NOVEMBER 2007

TYPICAL CHARACTERISTICS

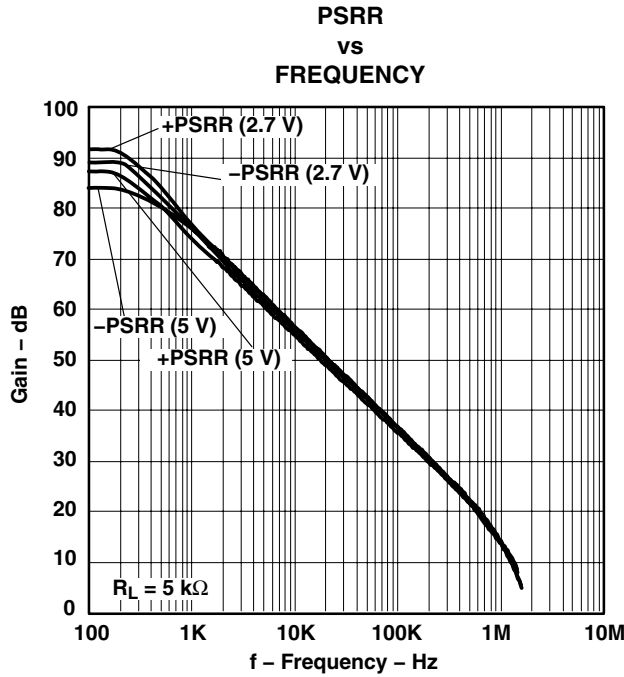

Figure 17

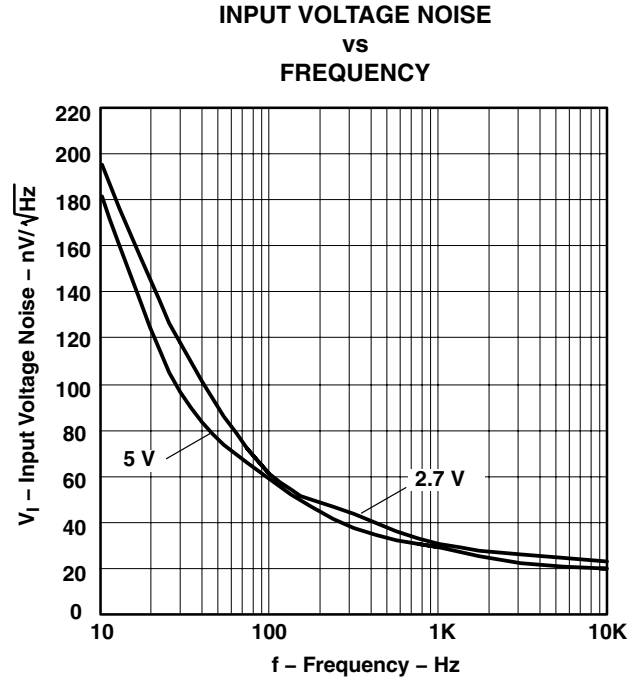

Figure 18

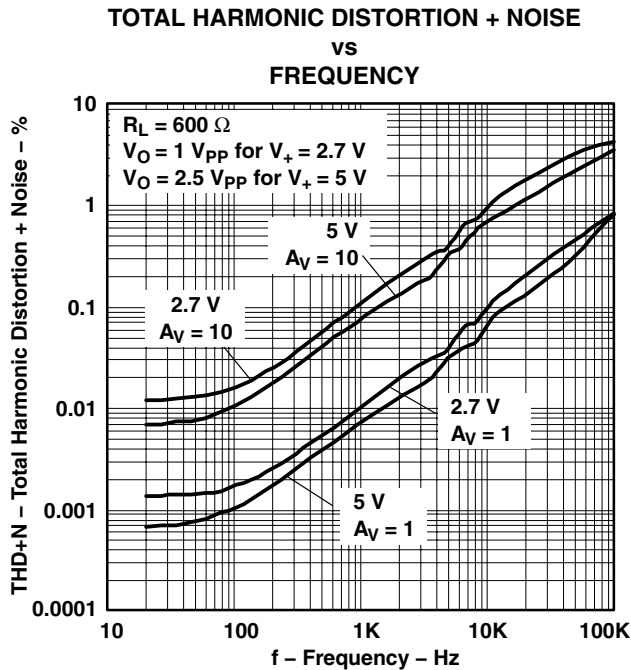

Figure 19

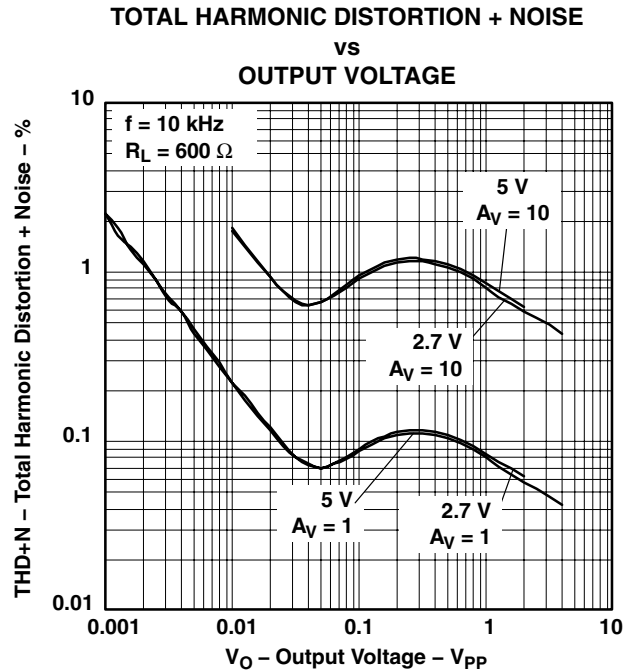

Figure 20



TLV341, TLV342, TLV342S, TLV344 LOW-VOLTAGE RAIL-TO-RAIL OUTPUT CMOS OPERATIONAL AMPLIFIERS WITH SHUTDOWN

SLV588C JANUARY 2006 REVISED NOVEMBER 2007
www.ti.com 查询TI芯片供应商

TYPICAL CHARACTERISTICS

FREQUENCY RESPONSE
vs
TEMPERATURE

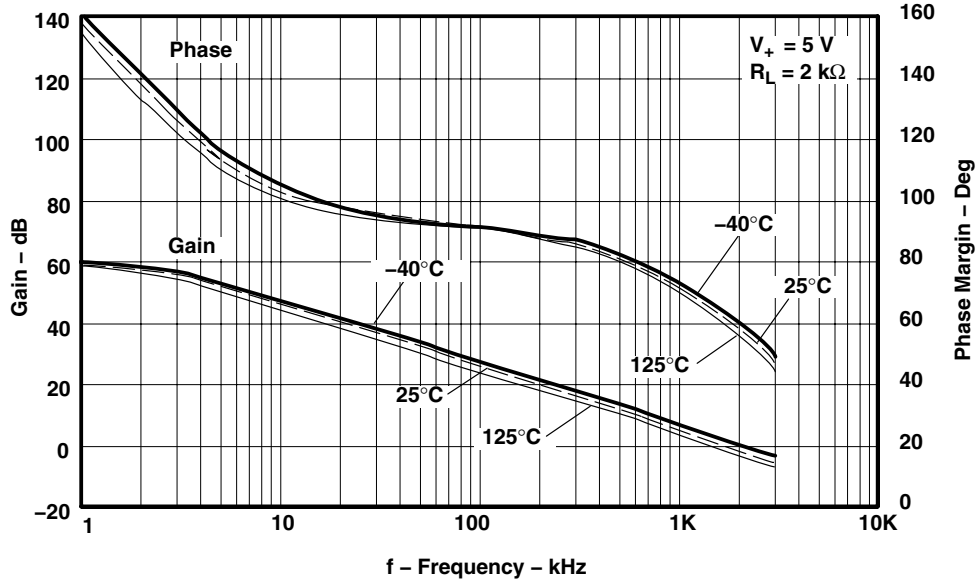

Figure 21

FREQUENCY RESPONSE
vs
 R_L

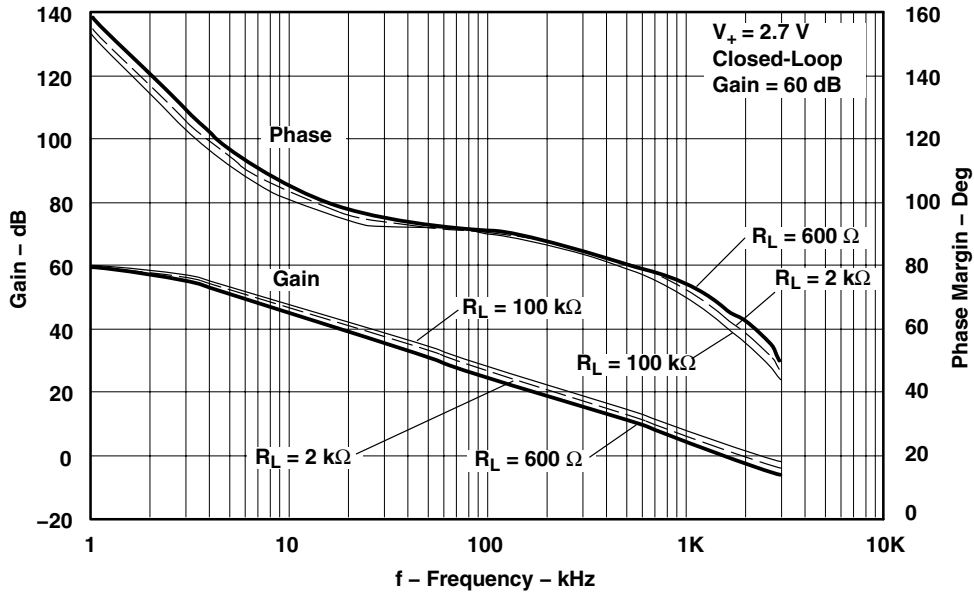

Figure 22



TLV341, TLV342, TLV342S, TLV344 LOW-VOLTAGE RAIL-TO-RAIL OUTPUT CMOS OPERATIONAL AMPLIFIERS WITH SHUTDOWN

[查询"TLV341"供应商](#)

SLVS568C – JANUARY 2005 – REVISED NOVEMBER 2007

TYPICAL CHARACTERISTICS

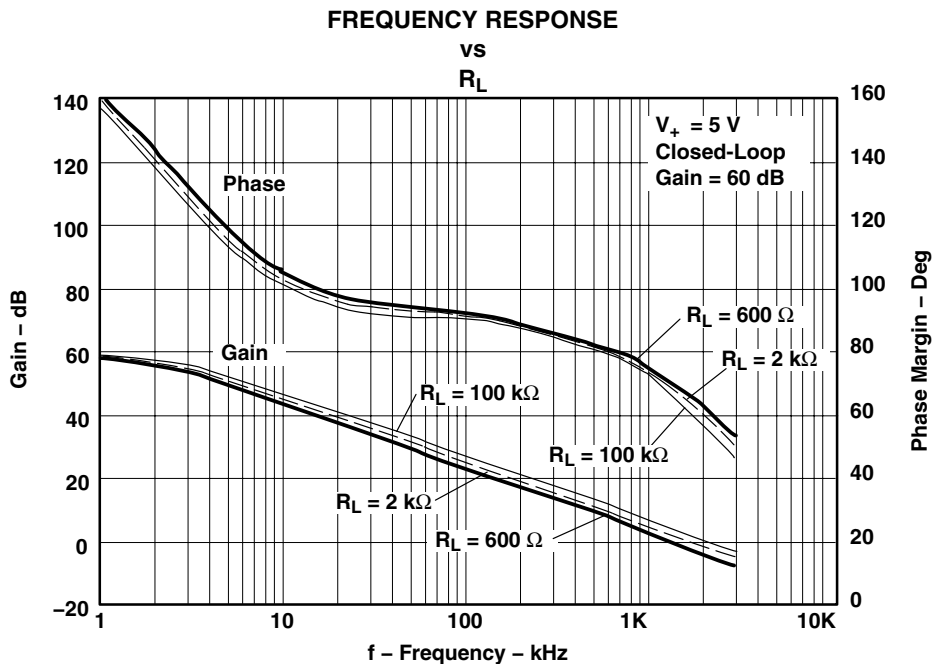

Figure 23

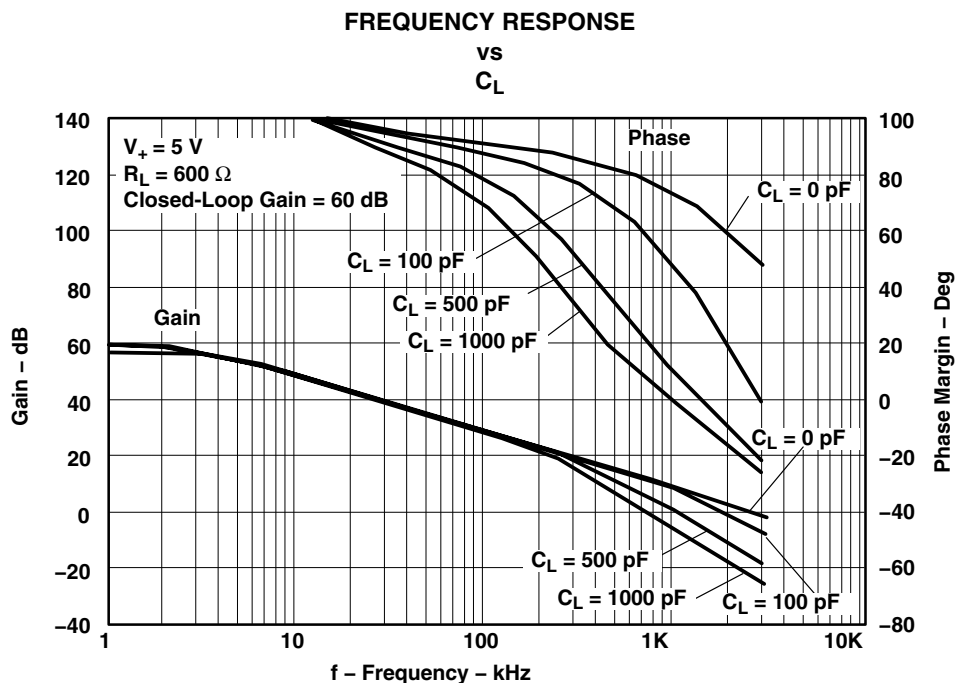

Figure 24



TLV341, TLV342, TLV342S, TLV344 LOW-VOLTAGE RAIL-TO-RAIL OUTPUT CMOS OPERATIONAL AMPLIFIERS WITH SHUTDOWN

SLV588C JANUARY 2006 REVISED NOVEMBER 2007
www.ti.com 查询 TI 器件信息

TYPICAL CHARACTERISTICS

SMALL-SIGNAL NONINVERTING RESPONSE

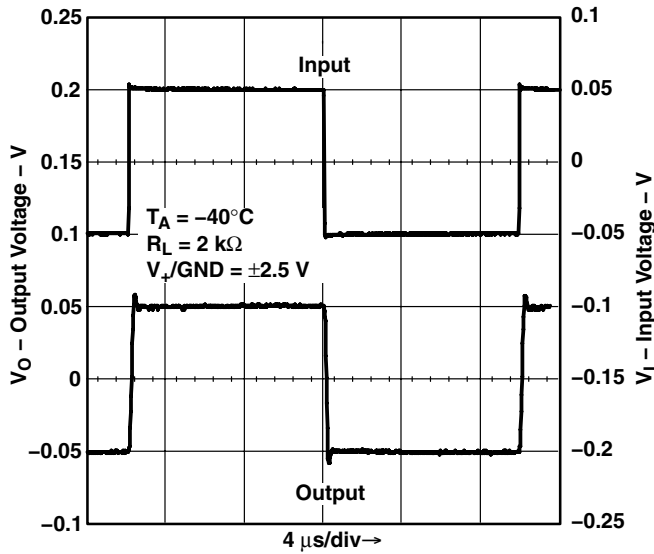

Figure 25

LARGE-SIGNAL NONINVERTING RESPONSE

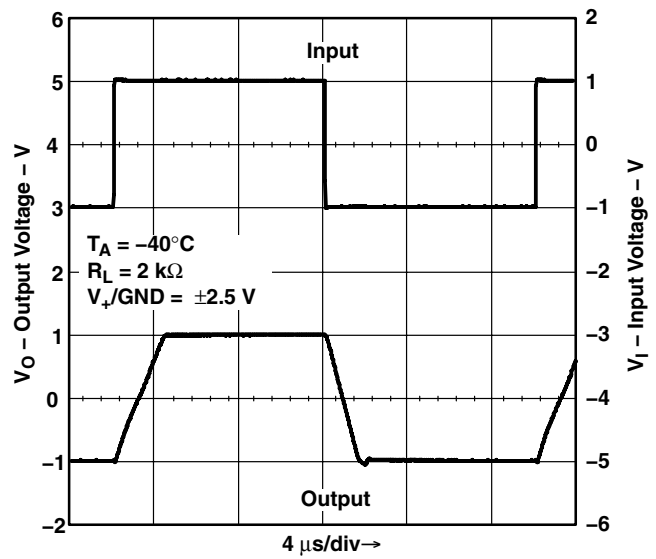

Figure 26

SMALL-SIGNAL NONINVERTING RESPONSE

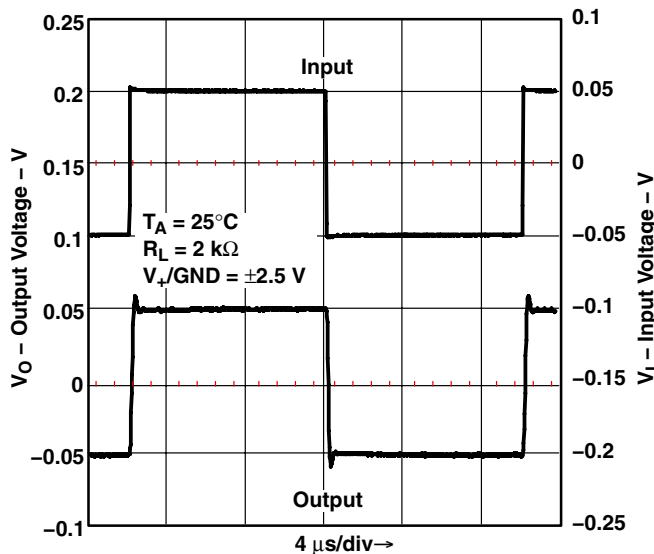

Figure 27

LARGE-SIGNAL NONINVERTING RESPONSE

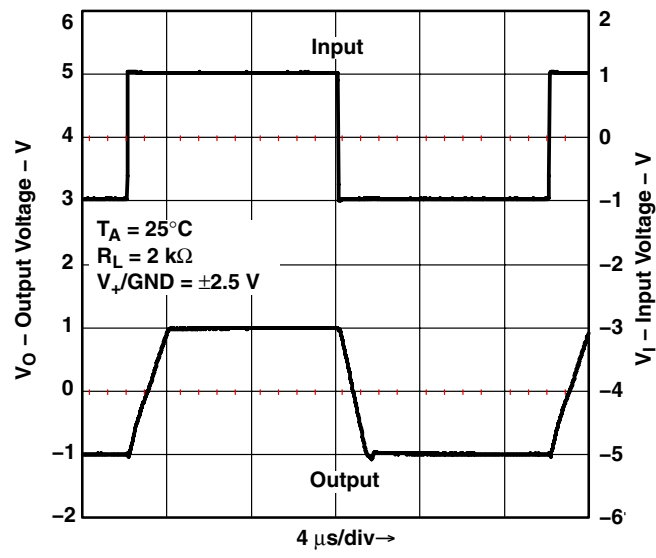

Figure 28

TLV341, TLV342, TLV342S, TLV344 LOW-VOLTAGE RAIL-TO-RAIL OUTPUT CMOS OPERATIONAL AMPLIFIERS WITH SHUTDOWN

查询"TLV341"供应商

SLVS568C – JANUARY 2005 – REVISED NOVEMBER 2007

TYPICAL CHARACTERISTICS

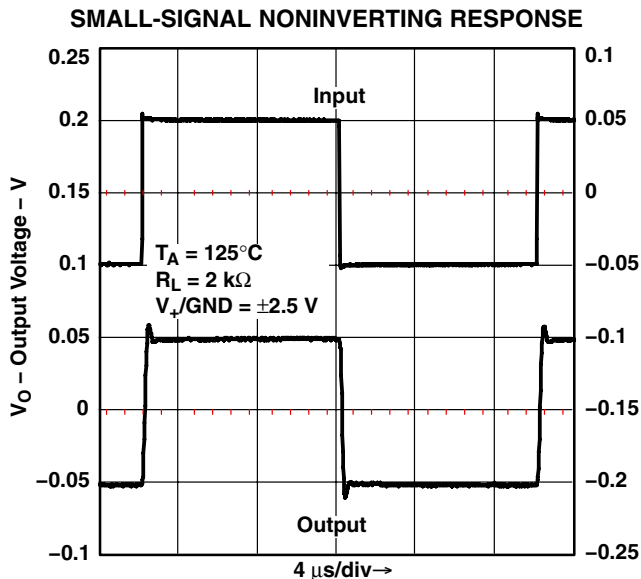

Figure 29

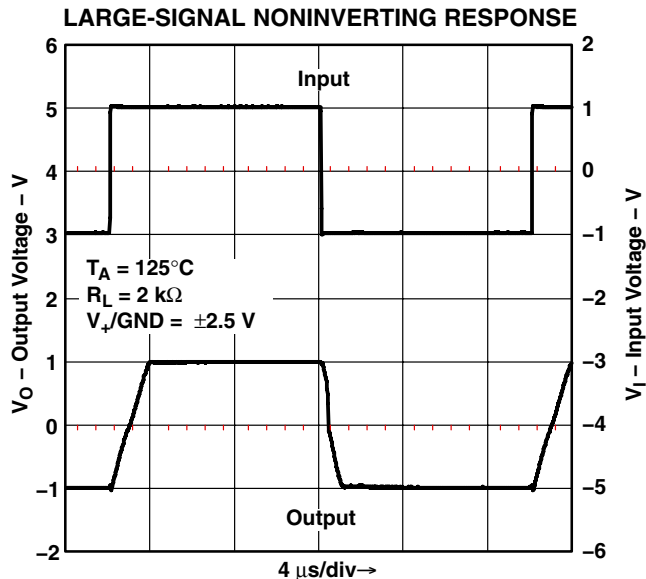

Figure 30

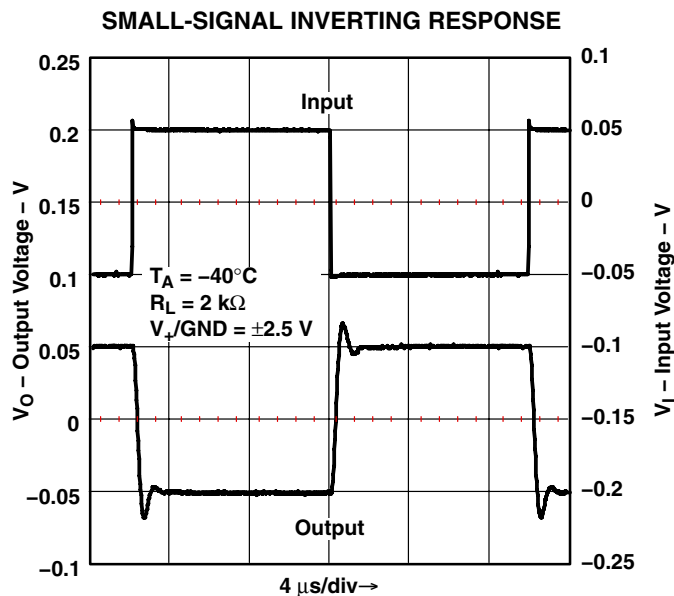

Figure 31

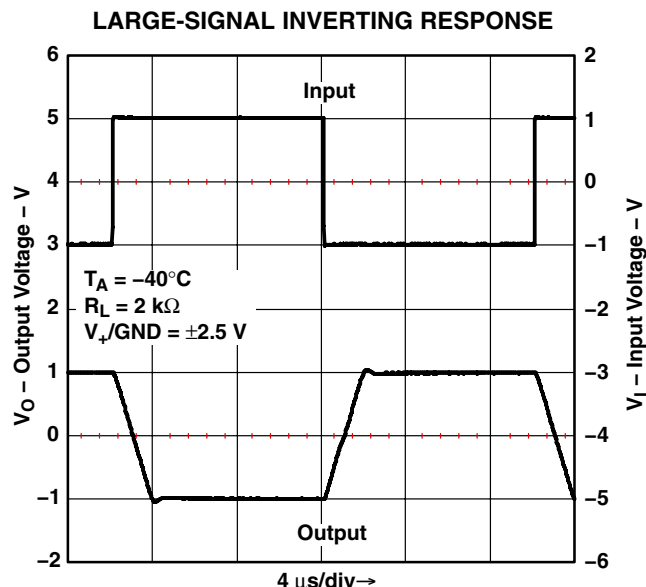

Figure 32



TLV341, TLV342, TLV342S, TLV344

LOW-VOLTAGE RAIL-TO-RAIL OUTPUT CMOS OPERATIONAL AMPLIFIERS WITH SHUTDOWN

SLV588C JANUARY 2006 REVISED NOVEMBER 2007

德州仪器 TLV341 代理商

TYPICAL CHARACTERISTICS

SMALL-SIGNAL INVERTING RESPONSE

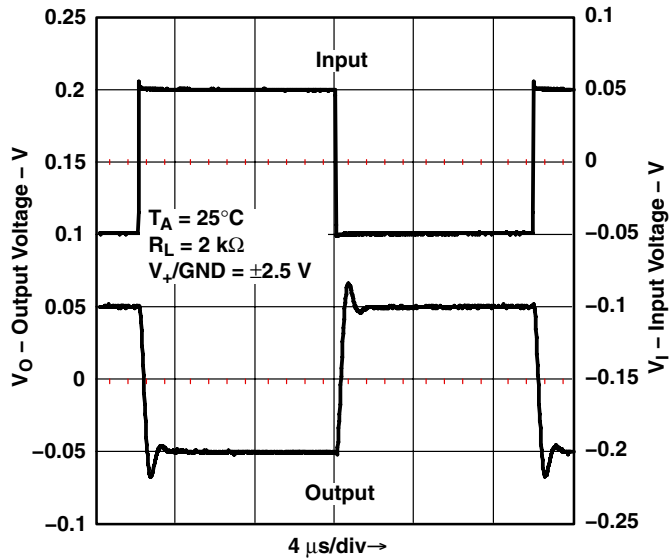

Figure 33

LARGE-SIGNAL INVERTING RESPONSE

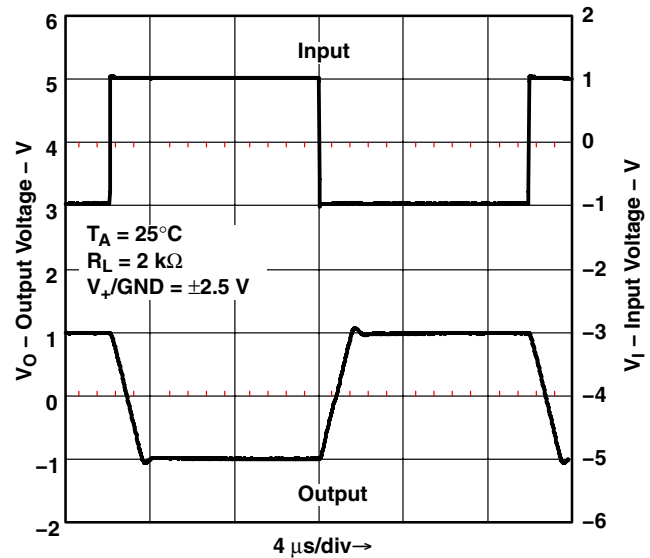

Figure 34

SMALL-SIGNAL INVERTING RESPONSE

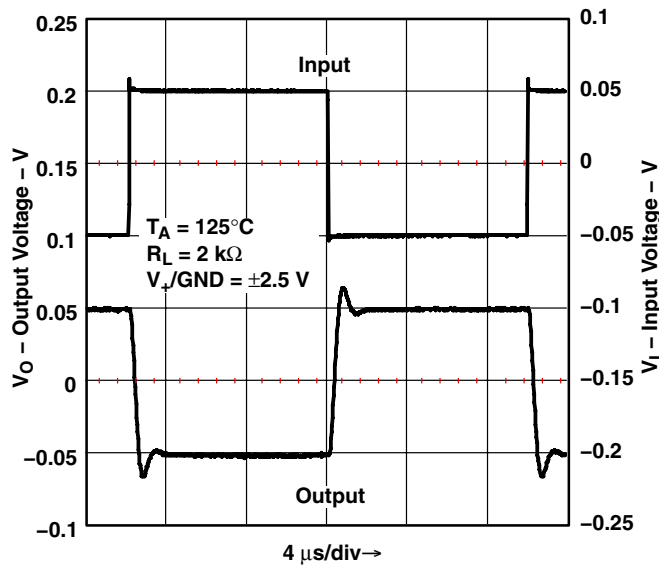

Figure 35

LARGE-SIGNAL INVERTING RESPONSE

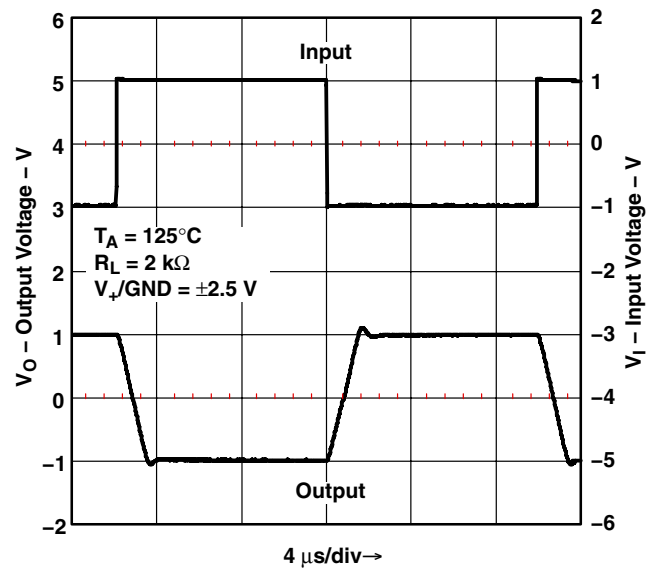

Figure 36

PACKAGING INFORMATION

Orderable Device	Status ⁽¹⁾	Package Type	Package Drawing	Pins	Package Qty	Eco Plan ⁽²⁾	Lead/Ball Finish	MSL Peak Temp ⁽³⁾
TLV341AIDBVR	ACTIVE	SOT-23	DBV	6	3000	Green (RoHS & no Sb/Br)	CU NIPDAU	Level-1-260C-UNLIM
TLV341AIDBVRE4	ACTIVE	SOT-23	DBV	6	3000	Green (RoHS & no Sb/Br)	CU NIPDAU	Level-1-260C-UNLIM
TLV341AIDBVRG4	ACTIVE	SOT-23	DBV	6	3000	Green (RoHS & no Sb/Br)	CU NIPDAU	Level-1-260C-UNLIM
TLV341AIDBVT	ACTIVE	SOT-23	DBV	6	250	Green (RoHS & no Sb/Br)	CU NIPDAU	Level-1-260C-UNLIM
TLV341AIDBVTE4	ACTIVE	SOT-23	DBV	6	250	Green (RoHS & no Sb/Br)	CU NIPDAU	Level-1-260C-UNLIM
TLV341AIDBVTG4	ACTIVE	SOT-23	DBV	6	250	Green (RoHS & no Sb/Br)	CU NIPDAU	Level-1-260C-UNLIM
TLV341AIDCKR	ACTIVE	SC70	DCK	6	3000	Green (RoHS & no Sb/Br)	CU NIPDAU	Level-1-260C-UNLIM
TLV341AIDCKRE4	ACTIVE	SC70	DCK	6	3000	Green (RoHS & no Sb/Br)	CU NIPDAU	Level-1-260C-UNLIM
TLV341AIDCKRG4	ACTIVE	SC70	DCK	6	3000	Green (RoHS & no Sb/Br)	CU NIPDAU	Level-1-260C-UNLIM
TLV341AIDCKT	ACTIVE	SC70	DCK	6	250	Green (RoHS & no Sb/Br)	CU NIPDAU	Level-1-260C-UNLIM
TLV341AIDCKTE4	ACTIVE	SC70	DCK	6	250	Green (RoHS & no Sb/Br)	CU NIPDAU	Level-1-260C-UNLIM
TLV341AIDCKTG4	ACTIVE	SC70	DCK	6	250	Green (RoHS & no Sb/Br)	CU NIPDAU	Level-1-260C-UNLIM
TLV341IDBVR	ACTIVE	SOT-23	DBV	6	3000	Green (RoHS & no Sb/Br)	CU NIPDAU	Level-1-260C-UNLIM
TLV341IDBVRE4	ACTIVE	SOT-23	DBV	6	3000	Green (RoHS & no Sb/Br)	CU NIPDAU	Level-1-260C-UNLIM
TLV341IDBVRG4	ACTIVE	SOT-23	DBV	6	3000	Green (RoHS & no Sb/Br)	CU NIPDAU	Level-1-260C-UNLIM
TLV341IDBVT	ACTIVE	SOT-23	DBV	6	250	Green (RoHS & no Sb/Br)	CU NIPDAU	Level-1-260C-UNLIM
TLV341IDBVTE4	ACTIVE	SOT-23	DBV	6	250	Green (RoHS & no Sb/Br)	CU NIPDAU	Level-1-260C-UNLIM
TLV341IDBVTG4	ACTIVE	SOT-23	DBV	6	250	Green (RoHS & no Sb/Br)	CU NIPDAU	Level-1-260C-UNLIM
TLV341IDCKR	ACTIVE	SC70	DCK	6	3000	Green (RoHS & no Sb/Br)	CU NIPDAU	Level-1-260C-UNLIM
TLV341IDCKRE4	ACTIVE	SC70	DCK	6	3000	Green (RoHS & no Sb/Br)	CU NIPDAU	Level-1-260C-UNLIM
TLV341IDCKRG4	ACTIVE	SC70	DCK	6	3000	Green (RoHS & no Sb/Br)	CU NIPDAU	Level-1-260C-UNLIM
TLV341IDCKT	ACTIVE	SC70	DCK	6	250	Green (RoHS & no Sb/Br)	CU NIPDAU	Level-1-260C-UNLIM
TLV341IDCKTE4	ACTIVE	SC70	DCK	6	250	Green (RoHS & no Sb/Br)	CU NIPDAU	Level-1-260C-UNLIM
TLV341IDCKTG4	ACTIVE	SC70	DCK	6	250	Green (RoHS & no Sb/Br)	CU NIPDAU	Level-1-260C-UNLIM
TLV341IDRLR	ACTIVE	SOT	DRL	6	4000	Green (RoHS & no Sb/Br)	CU NIPDAU	Level-1-260C-UNLIM

Orderable Device	Status ⁽¹⁾	Package Type	Package Drawing	Pins	Package Qty	Eco Plan ⁽²⁾	Lead/Ball Finish	MSL Peak Temp ⁽³⁾
TLV341IDRLRG4	ACTIVE	SOT	DRL	6	4000	Green (RoHS & no Sb/Br)	CU NIPDAU	Level-1-260C-UNLIM
TLV342AID	ACTIVE	SOIC	D	8	75	Green (RoHS & no Sb/Br)	CU NIPDAU	Level-1-260C-UNLIM
TLV342AIDE4	ACTIVE	SOIC	D	8	75	Green (RoHS & no Sb/Br)	CU NIPDAU	Level-1-260C-UNLIM
TLV342AIDG4	ACTIVE	SOIC	D	8	75	Green (RoHS & no Sb/Br)	CU NIPDAU	Level-1-260C-UNLIM
TLV342AIDR	ACTIVE	SOIC	D	8	2500	Green (RoHS & no Sb/Br)	CU NIPDAU	Level-1-260C-UNLIM
TLV342AIDRE4	ACTIVE	SOIC	D	8	2500	Green (RoHS & no Sb/Br)	CU NIPDAU	Level-1-260C-UNLIM
TLV342AIDRG4	ACTIVE	SOIC	D	8	2500	Green (RoHS & no Sb/Br)	CU NIPDAU	Level-1-260C-UNLIM
TLV342ID	ACTIVE	SOIC	D	8	75	Green (RoHS & no Sb/Br)	CU NIPDAU	Level-1-260C-UNLIM
TLV342IDE4	ACTIVE	SOIC	D	8	75	Green (RoHS & no Sb/Br)	CU NIPDAU	Level-1-260C-UNLIM
TLV342IDG4	ACTIVE	SOIC	D	8	75	Green (RoHS & no Sb/Br)	CU NIPDAU	Level-1-260C-UNLIM
TLV342IDGKR	ACTIVE	MSOP	DGK	8	2500	Green (RoHS & no Sb/Br)	CU NIPDAU	Level-1-260C-UNLIM
TLV342IDGKRG4	ACTIVE	MSOP	DGK	8	2500	Green (RoHS & no Sb/Br)	CU NIPDAU	Level-1-260C-UNLIM
TLV342IDR	ACTIVE	SOIC	D	8	2500	Green (RoHS & no Sb/Br)	CU NIPDAU	Level-1-260C-UNLIM
TLV342IDRE4	ACTIVE	SOIC	D	8	2500	Green (RoHS & no Sb/Br)	CU NIPDAU	Level-1-260C-UNLIM
TLV342IDRG4	ACTIVE	SOIC	D	8	2500	Green (RoHS & no Sb/Br)	CU NIPDAU	Level-1-260C-UNLIM
TLV342IRUGR	ACTIVE	X2QFN	RUG	10	3000	Green (RoHS & no Sb/Br)	CU NIPDAU	Level-1-260C-UNLIM
TLV342IRUGRG4	ACTIVE	X2QFN	RUG	10	3000	Green (RoHS & no Sb/Br)	CU NIPDAU	Level-1-260C-UNLIM
TLV342SIRUGR	ACTIVE	X2QFN	RUG	10	3000	Green (RoHS & no Sb/Br)	CU NIPDAU	Level-1-260C-UNLIM
TLV342SIRUGRG4	ACTIVE	X2QFN	RUG	10	3000	Green (RoHS & no Sb/Br)	CU NIPDAU	Level-1-260C-UNLIM

⁽¹⁾ The marketing status values are defined as follows:

ACTIVE: Product device recommended for new designs.

LIFEBUY: TI has announced that the device will be discontinued, and a lifetime-buy period is in effect.

NRND: Not recommended for new designs. Device is in production to support existing customers, but TI does not recommend using this part in a new design.

PREVIEW: Device has been announced but is not in production. Samples may or may not be available.

OBsolete: TI has discontinued the production of the device.

⁽²⁾ Eco Plan - The planned eco-friendly classification: Pb-Free (RoHS), Pb-Free (RoHS Exempt), or Green (RoHS & no Sb/Br) - please check <http://www.ti.com/productcontent> for the latest availability information and additional product content details.

TBD: The Pb-Free/Green conversion plan has not been defined.

Pb-Free (RoHS): TI's terms "Lead-Free" or "Pb-Free" mean semiconductor products that are compatible with the current RoHS requirements for all 6 substances, including the requirement that lead not exceed 0.1% by weight in homogeneous materials. Where designed to be soldered at high temperatures, TI Pb-Free products are suitable for use in specified lead-free processes.

Pb-Free (RoHS Exempt): This component has a RoHS exemption for either 1) lead-based flip-chip solder bumps used between the die and

package, or 2) lead-based die adhesive used between the die and leadframe. The component is otherwise considered Pb-Free (RoHS compatible) as defined above.

Green (RoHS & no Sb/Br): TI defines "Green" to mean Pb-Free (RoHS compatible), and free of Bromine (Br) and Antimony (Sb) based flame retardants (Br or Sb do not exceed 0.1% by weight in homogeneous material)

⁽³⁾ MSL, Peak Temp. -- The Moisture Sensitivity Level rating according to the JEDEC industry standard classifications, and peak solder temperature.

Important Information and Disclaimer:The information provided on this page represents TI's knowledge and belief as of the date that it is provided. TI bases its knowledge and belief on information provided by third parties, and makes no representation or warranty as to the accuracy of such information. Efforts are underway to better integrate information from third parties. TI has taken and continues to take reasonable steps to provide representative and accurate information but may not have conducted destructive testing or chemical analysis on incoming materials and chemicals. TI and TI suppliers consider certain information to be proprietary, and thus CAS numbers and other limited information may not be available for release.

In no event shall TI's liability arising out of such information exceed the total purchase price of the TI part(s) at issue in this document sold by TI to Customer on an annual basis.

TAPE AND REEL INFORMATION

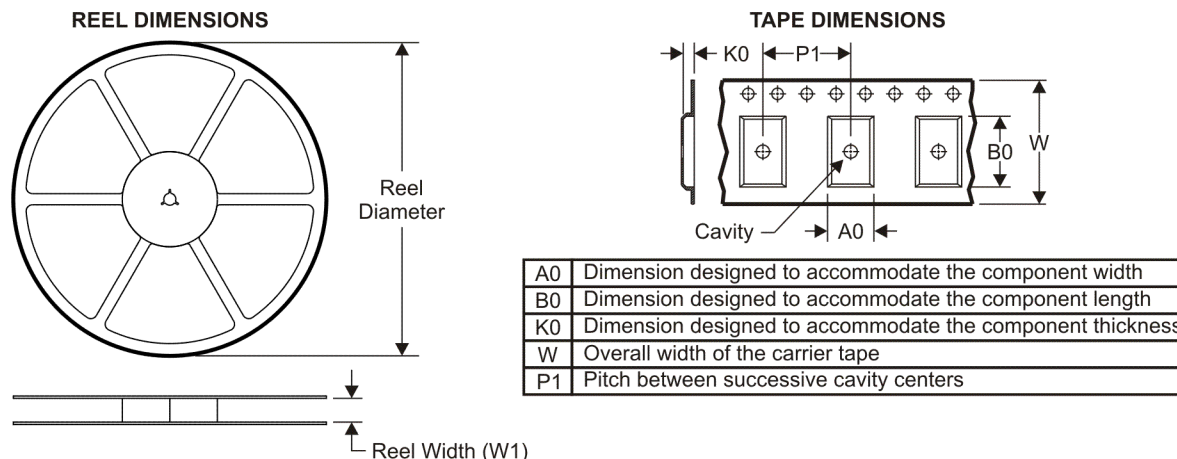

QUADRANT ASSIGNMENTS FOR PIN 1 ORIENTATION IN TAPE

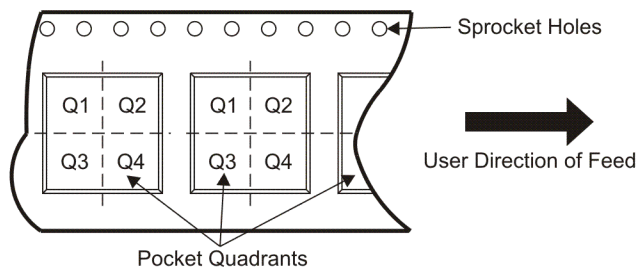

*All dimensions are nominal

Device	Package Type	Package Drawing	Pins	SPQ	Reel Diameter (mm)	Reel Width W1 (mm)	A0 (mm)	B0 (mm)	K0 (mm)	P1 (mm)	W (mm)	Pin1 Quadrant
TLV341AIDBVR	SOT-23	DBV	6	3000	179.0	8.4	3.2	3.2	1.4	4.0	8.0	Q3
TLV341AIDBVT	SOT-23	DBV	6	250	179.0	8.4	3.2	3.2	1.4	4.0	8.0	Q3
TLV341AIDCKR	SC70	DCK	6	3000	179.0	8.4	2.2	2.5	1.2	4.0	8.0	Q3
TLV341AIDCKT	SC70	DCK	6	250	179.0	8.4	2.2	2.5	1.2	4.0	8.0	Q3
TLV341IDBVR	SOT-23	DBV	6	3000	179.0	8.4	3.2	3.2	1.4	4.0	8.0	Q3
TLV341IDBVT	SOT-23	DBV	6	250	179.0	8.4	3.2	3.2	1.4	4.0	8.0	Q3
TLV341IDCKR	SC70	DCK	6	3000	179.0	8.4	2.2	2.5	1.2	4.0	8.0	Q3
TLV341IDCKT	SC70	DCK	6	250	179.0	8.4	2.2	2.5	1.2	4.0	8.0	Q3
TLV341IDRLR	SOT	DRL	6	4000	180.0	9.2	1.78	1.78	0.69	4.0	8.0	Q3
TLV342AIDR	SOIC	D	8	2500	330.0	12.4	6.4	5.2	2.1	8.0	12.0	Q1
TLV342IDGKR	MSOP	DGK	8	2500	330.0	12.4	5.3	3.4	1.4	8.0	12.0	Q1
TLV342IDR	SOIC	D	8	2500	330.0	12.4	6.4	5.2	2.1	8.0	12.0	Q1
TLV342IRUGR	X2QFN	RUG	10	3000	179.0	8.4	1.75	2.25	0.65	4.0	8.0	Q1
TLV342SIRUGR	X2QFN	RUG	10	3000	179.0	8.4	1.75	2.25	0.65	4.0	8.0	Q1

TAPE AND REEL BOX DIMENSIONS

*All dimensions are nominal

Device	Package Type	Package Drawing	Pins	SPQ	Length (mm)	Width (mm)	Height (mm)
TLV341AIDBVR	SOT-23	DBV	6	3000	203.0	203.0	35.0
TLV341AIDBVT	SOT-23	DBV	6	250	203.0	203.0	35.0
TLV341AIDCKR	SC70	DCK	6	3000	203.0	203.0	35.0
TLV341AIDCKT	SC70	DCK	6	250	203.0	203.0	35.0
TLV341IDBVR	SOT-23	DBV	6	3000	203.0	203.0	35.0
TLV341IDBVT	SOT-23	DBV	6	250	203.0	203.0	35.0
TLV341IDCKR	SC70	DCK	6	3000	203.0	203.0	35.0
TLV341IDCKT	SC70	DCK	6	250	203.0	203.0	35.0
TLV341IDRLR	SOT	DRL	6	4000	202.0	201.0	28.0
TLV342AIDR	SOIC	D	8	2500	340.5	338.1	20.6
TLV342IDGKR	MSOP	DGK	8	2500	358.0	335.0	35.0
TLV342IDR	SOIC	D	8	2500	340.5	338.1	20.6
TLV342IRUGR	X2QFN	RUG	10	3000	203.0	203.0	35.0
TLV342SIRUGR	X2QFN	RUG	10	3000	203.0	203.0	35.0

DBV (R-PDSO-G6)

PLASTIC SMALL-OUTLINE PACKAGE

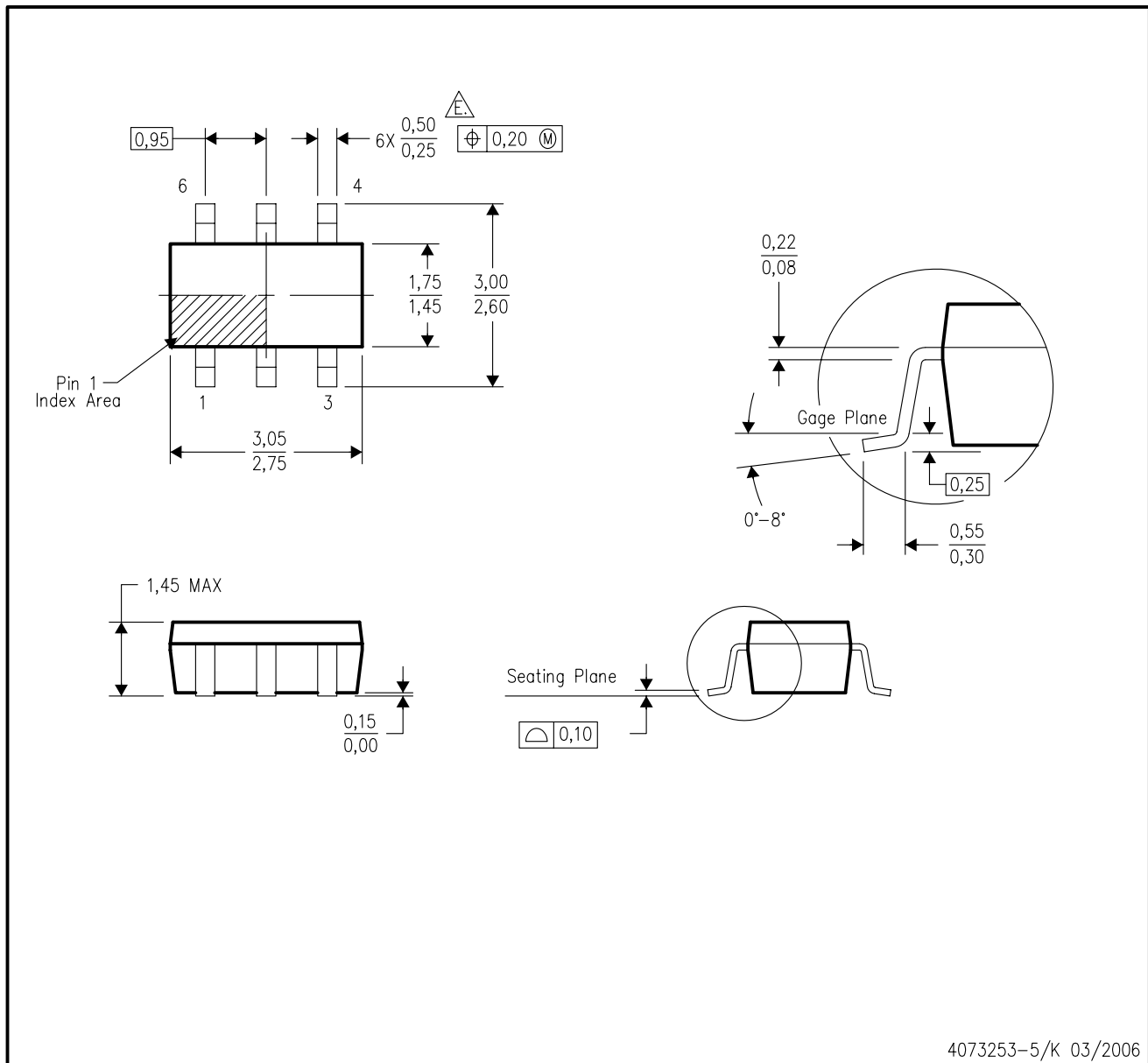

- NOTES:
- All linear dimensions are in millimeters.
 - This drawing is subject to change without notice.
 - Body dimensions do not include mold flash or protrusion. Mold flash and protrusion shall not exceed 0.15 per side.
 - Leads 1,2,3 may be wider than leads 4,5,6 for package orientation.
- \triangle Falls within JEDEC MO-178 Variation AB, except minimum lead width.

DGK (S-PDSO-G8)

PLASTIC SMALL-OUTLINE PACKAGE

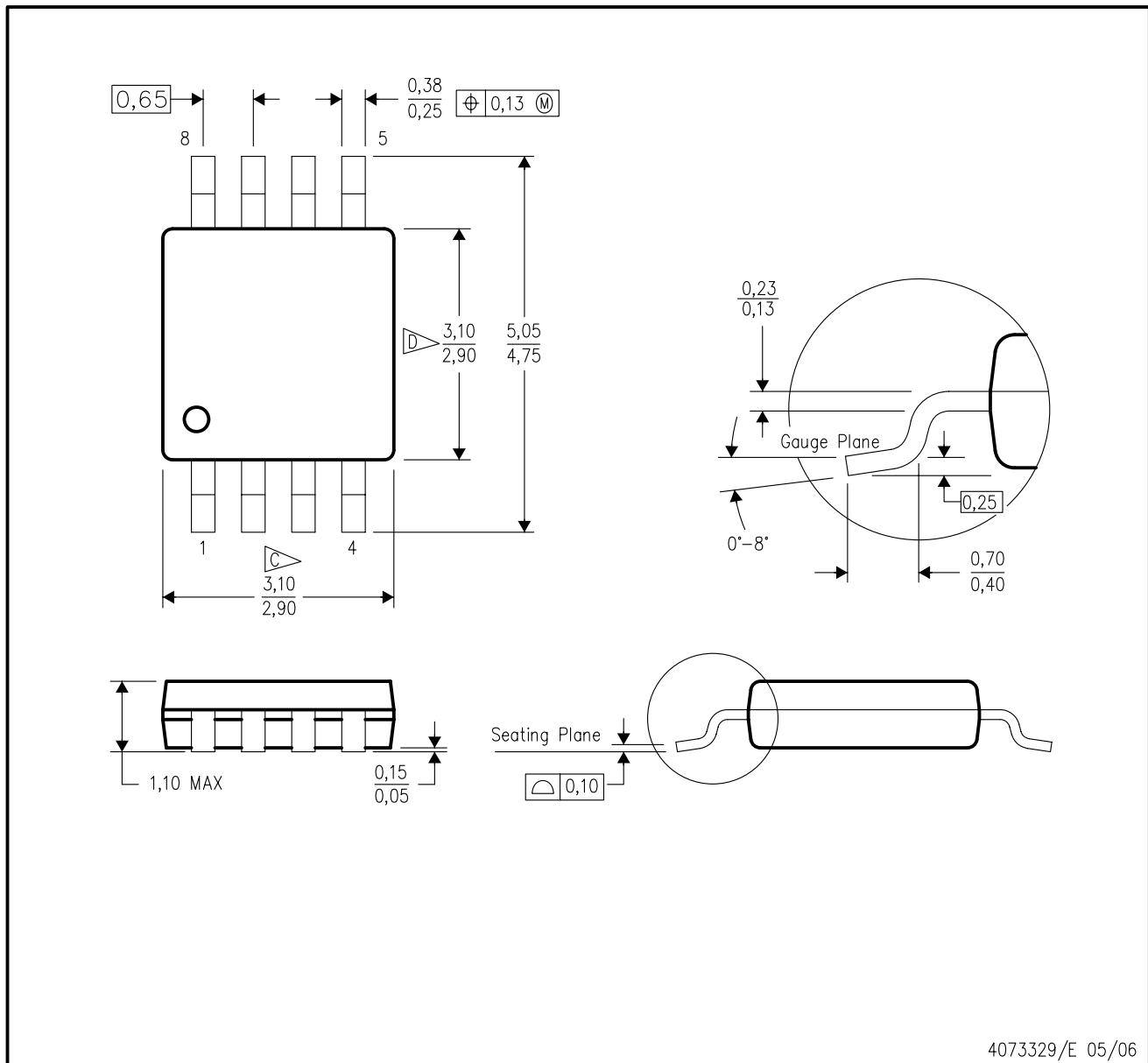

- NOTES:
- All linear dimensions are in millimeters.
 - This drawing is subject to change without notice.
 - \angle C Body length does not include mold flash, protrusions, or gate burrs. Mold flash, protrusions, or gate burrs shall not exceed 0.15 per end.
 - \angle D Body width does not include interlead flash. Interlead flash shall not exceed 0.50 per side.
 - Falls within JEDEC MO-187 variation AA, except interlead flash.

DCK (R-PDSO-G6)

PLASTIC SMALL-OUTLINE PACKAGE

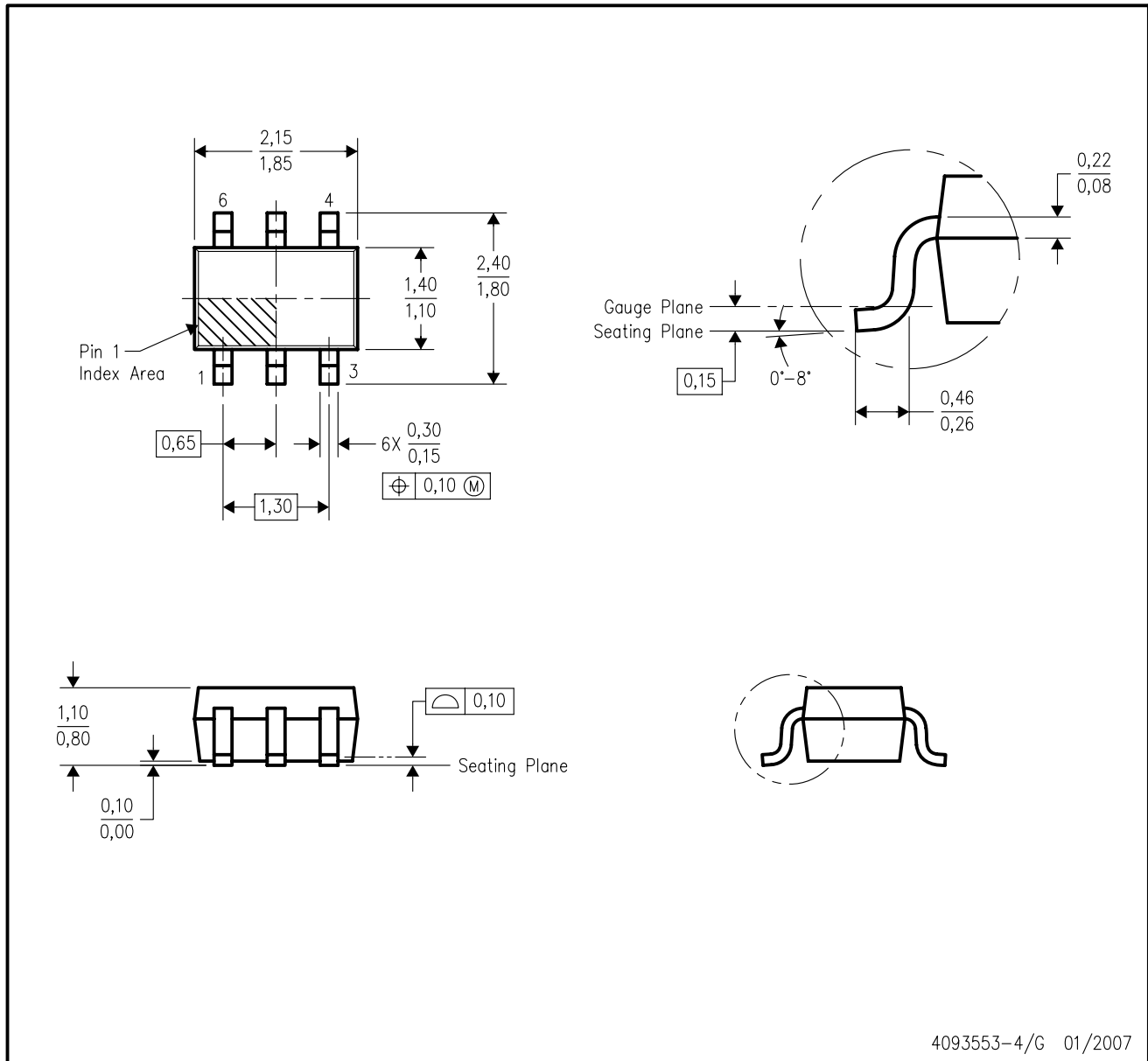

- NOTES:
- A. All linear dimensions are in millimeters.
 - B. This drawing is subject to change without notice.
 - C. Body dimensions do not include mold flash or protrusion. Mold flash and protrusion shall not exceed 0.15 per side.
 - D. Falls within JEDEC MO-203 variation AB.

DCK (R-PDSO-G6)

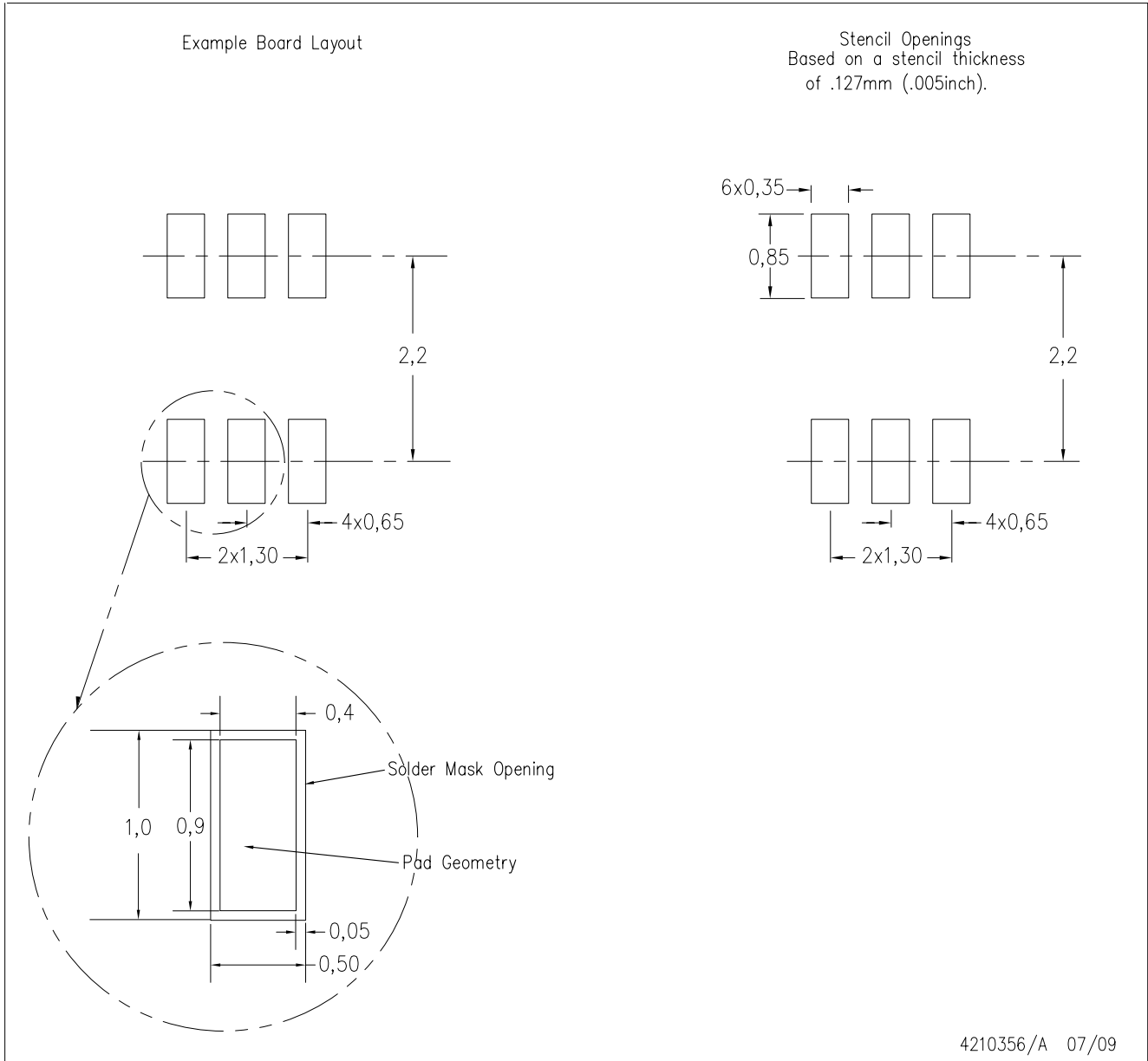

- NOTES:
- A. All linear dimensions are in millimeters.
 - B. This drawing is subject to change without notice.
 - C. Customers should place a note on the circuit board fabrication drawing not to alter the center solder mask defined pad.
 - D. Publication IPC-7351 is recommended for alternate designs.
 - E. Laser cutting apertures with trapezoidal walls and also rounding corners will offer better paste release. Customers should contact their board assembly site for stencil design recommendations. Example stencil design based on a 50% volumetric metal load solder paste. Refer to IPC-7525 for other stencil recommendations.

DRL (R-PDSO-N6)

PLASTIC SMALL OUTLINE

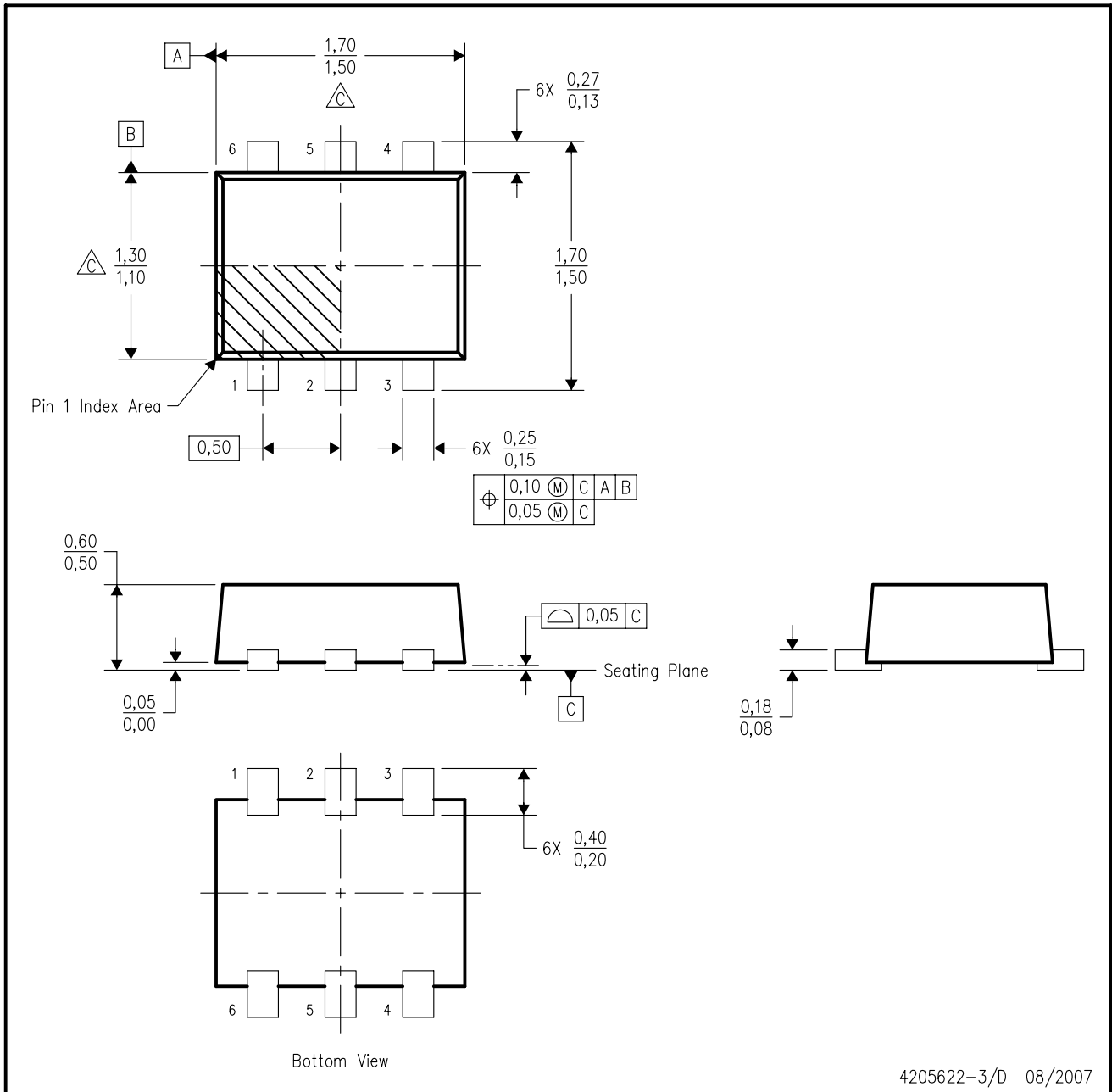

- NOTES:
- A. All linear dimensions are in millimeters. Dimensioning and tolerancing per ASME Y14.5M-1994.
 - B. This drawing is subject to change without notice.
 - C. Body dimensions do not include mold flash, interlead flash, protrusions, or gate burrs. Mold flash, interlead flash, protrusions, or gate burrs shall not exceed 0,15 per end or side.
 - D. JEDEC package registration is pending.

[查询"TLV341"供应商](#)

DRL (R-PDSO-N6)

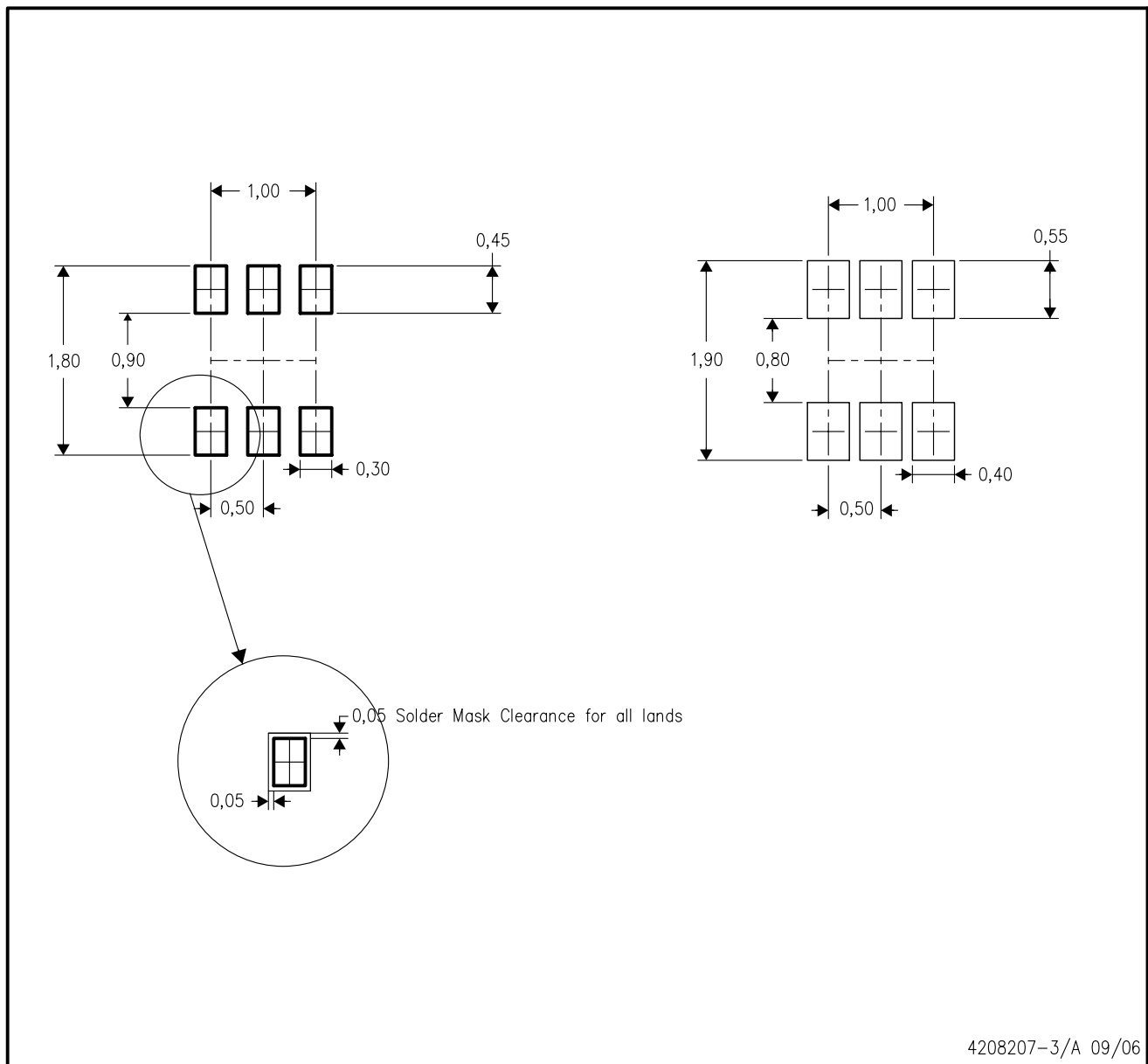

- NOTES:
- All linear dimensions are in millimeters.
 - This drawing is subject to change without notice.
 - Publication IPC-7351 is recommended for alternate designs.
 - Customers should contact their board fabrication site for minimum solder mask web tolerances between signal pads.
 - Maximum stencil thickness 0,127 mm (5 mils). All linear dimensions are in millimeters.
 - Laser cutting apertures with trapezoidal walls and also rounding corners will offer better paste release. Customers should contact their board assembly site for stencil design recommendations. Refer to IPC 7525 for stencil design considerations.
 - Side aperture dimensions over-print land for acceptable area ratio > 0.66. Customer may reduce side aperture dimensions if stencil manufacturing process allows for sufficient release at smaller opening.

[查询"TLV341"供应商](#)

RUG (R-PQFP-N10)

PLASTIC QUAD FLATPACK

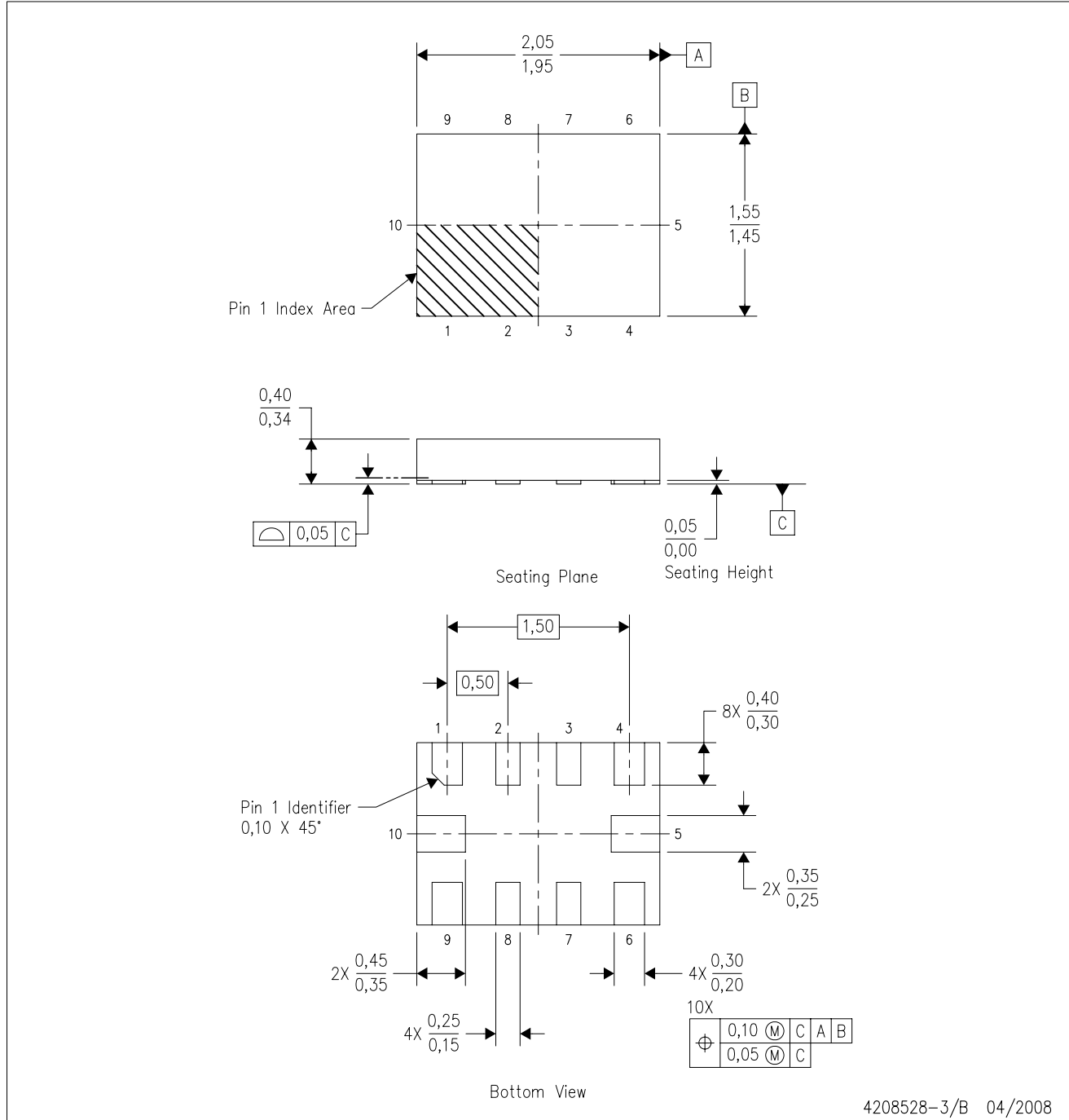

4208528-3/B 04/2008

- NOTES:
- A. All linear dimensions are in millimeters. Dimensioning and tolerancing per ASME Y14.5M-1994.
 - B. This drawing is subject to change without notice.
 - C. QFN (Quad Flatpack No-Lead) package configuration.
 - D. This package complies to JEDEC MO-288 variation X2EFD.

RUG (R-PQFP-N10)

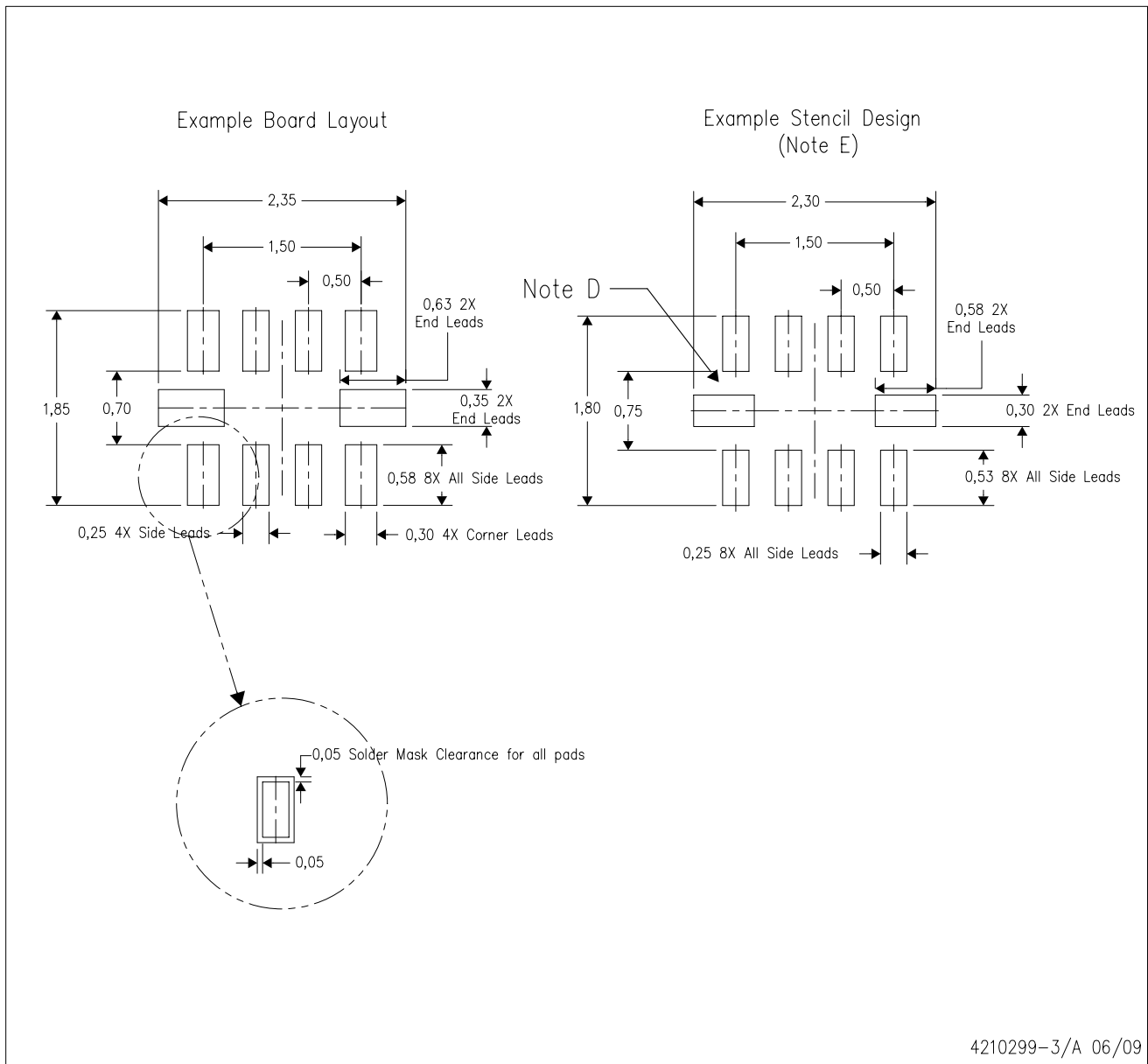

- NOTES:
- A. All linear dimensions are in millimeters.
 - B. This drawing is subject to change without notice.
 - C. Publication IPC-7351 is recommended for alternate designs.
 - D. Customers should contact their board fabrication site for minimum solder mask web tolerances between signal pads.
 - E. Maximum stencil thickness 0,127 mm (5 mils). All linear dimensions are in millimeters.
 - F. Laser cutting apertures with trapezoidal walls and also rounding corners will offer better paste release. Customers should contact their board assembly site for stencil design recommendations. Refer to IPC 7525 for stencil design considerations.
 - G. Side aperture dimensions over-print land for acceptable area ratio > 0.66. Customer may reduce side aperture dimensions if stencil manufacturing process allows for sufficient release at smaller opening.

D (R-PDSO-G8)

PLASTIC SMALL-OUTLINE PACKAGE

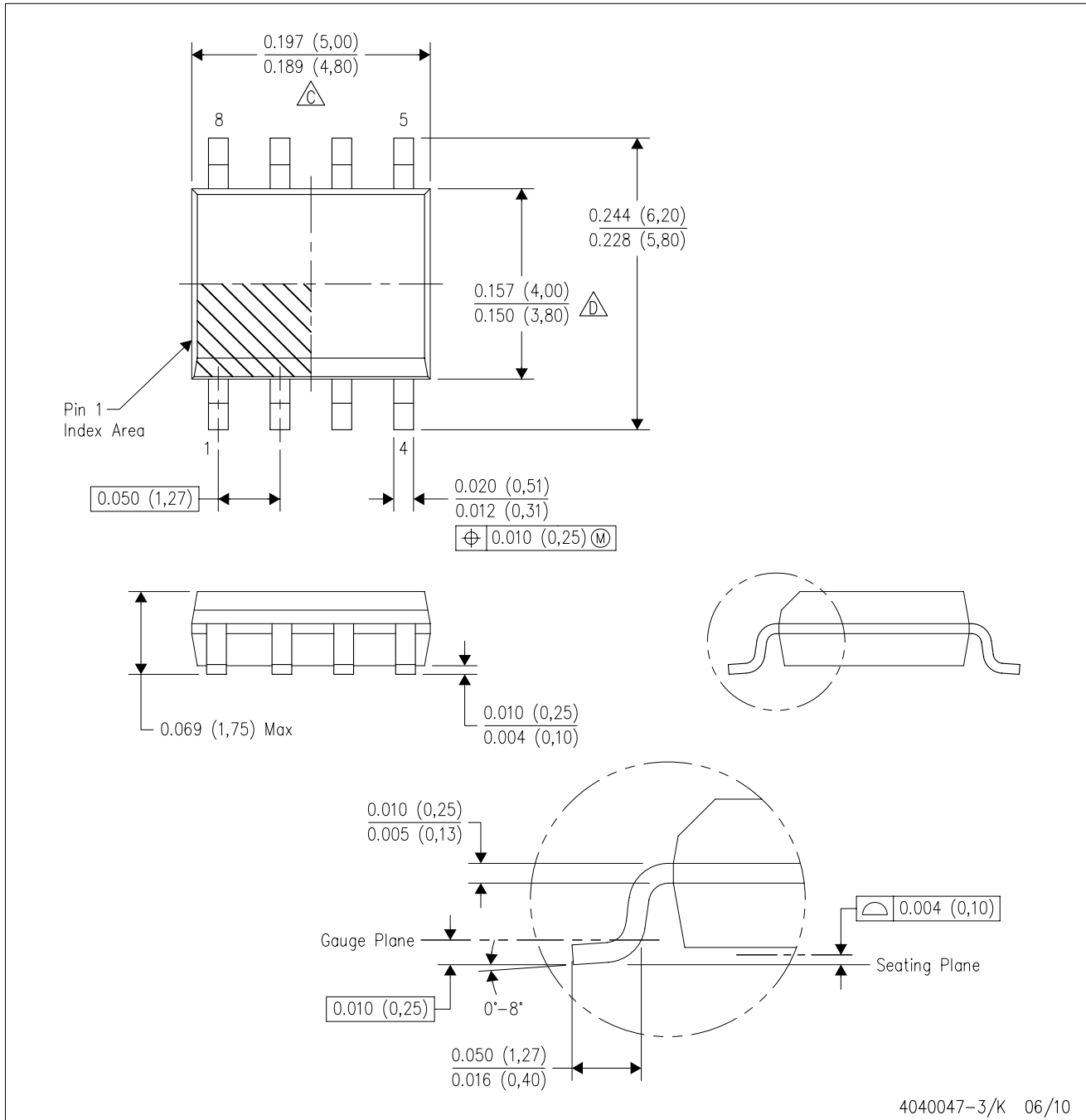

D (R-PDSO-G8)

PLASTIC SMALL OUTLINE

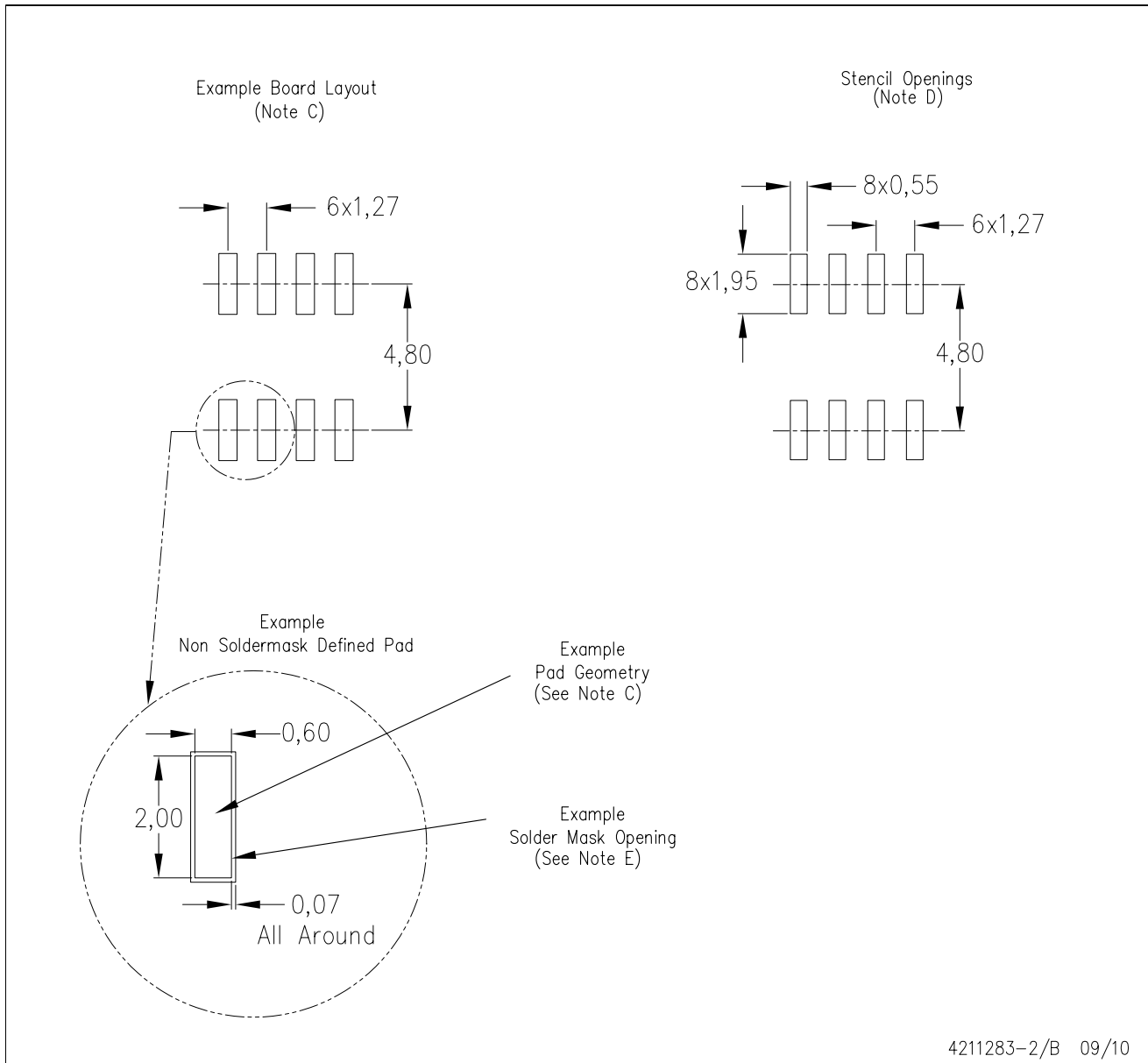

- NOTES:
- All linear dimensions are in millimeters.
 - This drawing is subject to change without notice.
 - Publication IPC-7351 is recommended for alternate designs.
 - Laser cutting apertures with trapezoidal walls and also rounding corners will offer better paste release. Customers should contact their board assembly site for stencil design recommendations. Refer to IPC-7525 for other stencil recommendations.
 - Customers should contact their board fabrication site for solder mask tolerances between and around signal pads.

IMPORTANT NOTICE

Texas Instruments Incorporated and its subsidiaries (TI) reserve the right to make corrections, modifications, enhancements, improvements, and other changes to its products and services at any time and to discontinue any product or service without notice. Customers should obtain the latest relevant information before placing orders and should verify that such information is current and complete. All products are sold subject to TI's terms and conditions of sale supplied at the time of order acknowledgment.

TI warrants performance of its hardware products to the specifications applicable at the time of sale in accordance with TI's standard warranty. Testing and other quality control techniques are used to the extent TI deems necessary to support this warranty. Except where mandated by government requirements, testing of all parameters of each product is not necessarily performed.

TI assumes no liability for applications assistance or customer product design. Customers are responsible for their products and applications using TI components. To minimize the risks associated with customer products and applications, customers should provide adequate design and operating safeguards.

TI does not warrant or represent that any license, either express or implied, is granted under any TI patent right, copyright, mask work right, or other TI intellectual property right relating to any combination, machine, or process in which TI products or services are used. Information published by TI regarding third-party products or services does not constitute a license from TI to use such products or services or a warranty or endorsement thereof. Use of such information may require a license from a third party under the patents or other intellectual property of the third party, or a license from TI under the patents or other intellectual property of TI.

Reproduction of TI information in TI data books or data sheets is permissible only if reproduction is without alteration and is accompanied by all associated warranties, conditions, limitations, and notices. Reproduction of this information with alteration is an unfair and deceptive business practice. TI is not responsible or liable for such altered documentation. Information of third parties may be subject to additional restrictions.

Resale of TI products or services with statements different from or beyond the parameters stated by TI for that product or service voids all express and any implied warranties for the associated TI product or service and is an unfair and deceptive business practice. TI is not responsible or liable for any such statements.

TI products are not authorized for use in safety-critical applications (such as life support) where a failure of the TI product would reasonably be expected to cause severe personal injury or death, unless officers of the parties have executed an agreement specifically governing such use. Buyers represent that they have all necessary expertise in the safety and regulatory ramifications of their applications, and acknowledge and agree that they are solely responsible for all legal, regulatory and safety-related requirements concerning their products and any use of TI products in such safety-critical applications, notwithstanding any applications-related information or support that may be provided by TI. Further, Buyers must fully indemnify TI and its representatives against any damages arising out of the use of TI products in such safety-critical applications.

TI products are neither designed nor intended for use in military/aerospace applications or environments unless the TI products are specifically designated by TI as military-grade or "enhanced plastic." Only products designated by TI as military-grade meet military specifications. Buyers acknowledge and agree that any such use of TI products which TI has not designated as military-grade is solely at the Buyer's risk, and that they are solely responsible for compliance with all legal and regulatory requirements in connection with such use.

TI products are neither designed nor intended for use in automotive applications or environments unless the specific TI products are designated by TI as compliant with ISO/TS 16949 requirements. Buyers acknowledge and agree that, if they use any non-designated products in automotive applications, TI will not be responsible for any failure to meet such requirements.

Following are URLs where you can obtain information on other Texas Instruments products and application solutions:

Products		Applications	
Amplifiers	amplifier.ti.com	Audio	www.ti.com/audio
Data Converters	dataconverter.ti.com	Automotive	www.ti.com/automotive
DLP® Products	www.dlp.com	Communications and Telecom	www.ti.com/communications
DSP	dsp.ti.com	Computers and Peripherals	www.ti.com/computers
Clocks and Timers	www.ti.com/clocks	Consumer Electronics	www.ti.com/consumer-apps
Interface	interface.ti.com	Energy	www.ti.com/energy
Logic	logic.ti.com	Industrial	www.ti.com/industrial
Power Mgmt	power.ti.com	Medical	www.ti.com/medical
Microcontrollers	microcontroller.ti.com	Security	www.ti.com/security
RFID	www.ti-rfid.com	Space, Avionics & Defense	www.ti.com/space-avionics-defense
RF/IF and ZigBee® Solutions	www.ti.com/lprf	Video and Imaging	www.ti.com/video
		Wireless	www.ti.com/wireless-apps