

# CPU 5-Bit Synchronous Buck Controller

The CS5160 is a 5-bit synchronous dual N-Channel buck controllers designed to provide unprecedented transient response for today's demanding high-density, high-speed logic. It operates using a proprietary control method which allows a 100 ns response time to load transients. The CS5160 is designed to operate over a 9–16 V range ( $V_{CC}$ ) using 12 V to power the IC and 5.0 V as the main supply for conversion.

The CS5160 is specifically designed to power Pentium® III processors and other high performance core logic. They include the following features: on board 5-bit DAC, short circuit protection, 1.0% output tolerance,  $V_{CC}$  monitor, and programmable Soft Start capability. The CS5160 is available in a 16 pin surface mount package.

## Features

- Dual N-Channel Design
- Excess of 1.0 MHz Operation
- 100 ns Transient Response
- 5-Bit DAC
- Backward Compatible with CS515X Family
- 30 ns Gate Rise/Fall Times
- 0.8% DAC Accuracy for the 01111 DAC Code
- 5.0 V & 12 V Operation
- Remote Sense
- Programmable Soft Start
- Lossless Short Circuit Protection
- $V_{CC}$  Monitor
- $V^2$ ™ Control Topology
- Overvoltage Protection



**ON Semiconductor™**

<http://onsemi.com>

## MARKING DIAGRAMS



**SOIC-16  
D SUFFIX  
CASE 751B**

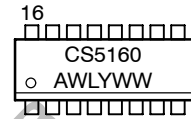

A = Assembly Location  
 WL, L = Wafer Lot  
 YY, Y = Year  
 WW, W = Work Week

## PIN CONNECTIONS

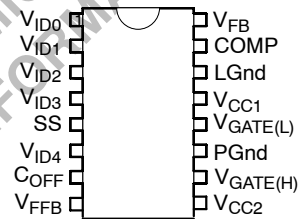

## ORDERING INFORMATION

Device	Package	Shipping
CS5160GD16	SO-16	48 Units/Rail
CS5160GDR16	SO-16	2500 Tape & Reel

[查询"CS5160GD16"供应商](#)

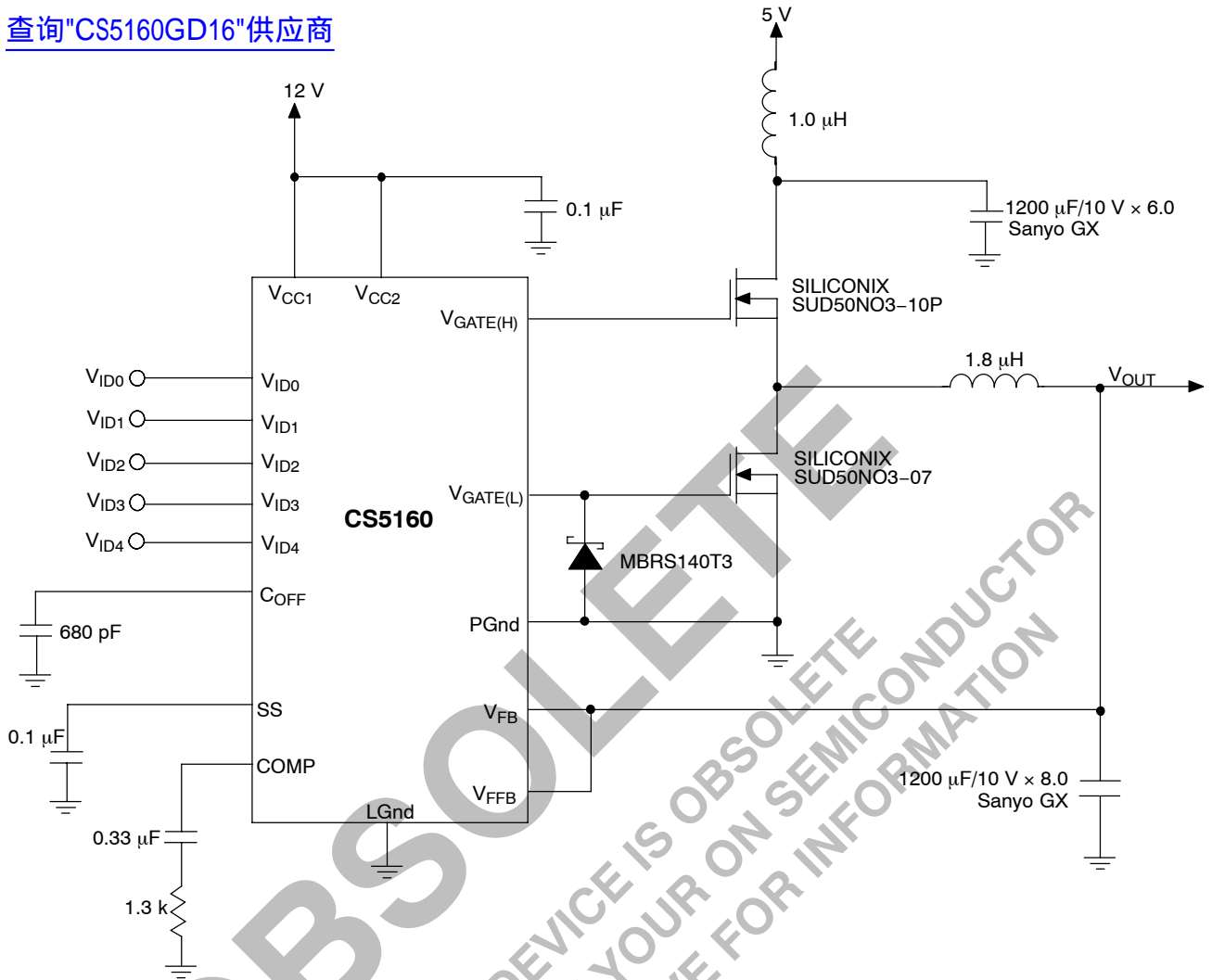

Figure 1. Application Diagram, 5.0 V to 1.5 V/15 A Core Logic Converter with 12 V Bias

**MAXIMUM RATINGS\***

Rating	Value	Unit
Operating Junction Temperature, $T_J$	0 to 150	°C
Lead Temperature Soldering:	Reflow: (SMD styles only) (Note 1)	230 peak
Storage Temperature Range, $T_S$	-65 to +150	°C
ESD Susceptibility (Human Body Model)	2.0	kV

1. 60 second maximum above 183°C.

\*The maximum package power dissipation must be observed.

**MAXIMUM RATINGS**

Pin Name	Max Operating Voltage	Max Current
$V_{CC1}$	16 V/-0.3 V	100 mA DC/1.5 A peak
$V_{CC2}$	18 V/-0.3 V	100 mA DC/1.5 A peak
SS	6.0 V/-0.3 V	-100 $\mu$ A
COMP	6.0 V/-0.3 V	200 $\mu$ A

# CS5160

## MAXIMUM RATINGS (continued)

查询 CS5160GD16 供应商

Pin Name	Max Operating Voltage	Max Current
V <sub>FB</sub>	6.0 V/-0.3 V	-0.2 μA
C <sub>OFF</sub>	6.0 V/-0.3 V	-0.2 μA
V <sub>FFB</sub>	6.0 V/-0.3 V	-0.2 μA
V <sub>ID0</sub> - V <sub>ID4</sub>	6.0 V/-0.3 V	-50 μA
V <sub>GATE(H)</sub>	18 V/-0.3 V	100 mA DC/1.5 A peak
V <sub>GATE(L)</sub>	16 V/-0.3 V	100 mA DC/1.5 A peak
L <sub>Gnd</sub>	0 V	25 mA
P <sub>Gnd</sub>	0 V	100 mA DC/1.5 A peak

## ELECTRICAL CHARACTERISTICS (0°C < T<sub>A</sub> < +70°C; 0°C < T<sub>J</sub> < +85°C; 9.5 V < V<sub>CC1</sub> < 14 V; 5.0 V < V<sub>CC2</sub> < 16 V; DAC

Code: V<sub>ID4</sub> = V<sub>ID2</sub> = V<sub>ID1</sub> = V<sub>ID0</sub> = 1; V<sub>ID3</sub> = 0; C<sub>V<sub>GATE(L)</sub></sub> and C<sub>V<sub>GATE(H)</sub></sub> = 1.0 nF; C<sub>OFF</sub> = 330 pF; C<sub>SS</sub> = 0.1 μF, unless otherwise specified.)

Characteristic	Test Conditions	Min	Typ	Max	Unit
<b>Error Amplifier</b>					
V <sub>FB</sub> Bias Current	V <sub>FB</sub> = 0 V	-	0.3	1.0	μA
Open Loop Gain	1.25 V < V <sub>COMP</sub> , 4.0 V; C <sub>COMP</sub> = 0.1 μF; Note 2	-	80	-	dB
Unity Gain Bandwidth	C <sub>COMP</sub> = 0.1 μF; Note 2	-	50	-	kHz
COMP SINK Current	V <sub>COMP</sub> = 1.5 V; V <sub>FB</sub> = 3.0 V; V <sub>SS</sub> > 2.0 V	30	60	120	μA
COMP SOURCE Current	V <sub>COMP</sub> = 1.2 V; V <sub>FB</sub> = 2.7 V; V <sub>SS</sub> = 5.0 V	15	30	60	μA
COMP CLAMP Current	V <sub>COMP</sub> = 0 V; V <sub>FB</sub> = 2.7 V	0.4	1.0	1.6	mA
COMP High Voltage	V <sub>FB</sub> = 2.7 V; V <sub>SS</sub> = 5.0 V	4.0	4.3	5.0	V
COMP Low Voltage	V <sub>FB</sub> = 3.0 V	-	1.00	1.15	V
PSRR	8.0 V < V <sub>CC1</sub> < 14 V @ 1.0 kHz; C <sub>COMP</sub> = 0.1 μF; Note 2	-	70	-	dB
Transconductance	-	-	33	-	mmho

## V<sub>CC1</sub> Monitor

Start Threshold	Output switching	8.60	8.95	9.30	V
Stop Threshold	Output not switching	8.45	8.80	9.15	V
Hysteresis	Start-Stop	-	150	-	mV

## Soft Start (SS)

Charge Time	-	1.6	3.3	5.0	ms
Pulse Period	-	25	100	200	ms
Duty Cycle	(Charge Time / Pulse Period) × 100	1.0	3.3	6.0	%
COMP Clamp Voltage	V <sub>FB</sub> = 0 V; V <sub>SS</sub> = 0	0.50	0.95	1.10	V
V <sub>FFB</sub> SS Fault Disable	V <sub>GATE(H)</sub> = Low; V <sub>GATE(L)</sub> = Low	0.9	1.0	1.1	V
High Threshold	-	-	2.5	3.0	V

2. Guaranteed by design, not 100% tested in production.

# CS5160

**ELECTRICAL CHARACTERISTICS (continued)** (0°C < T<sub>A</sub> < +70°C; 0°C < T<sub>J</sub> < +85°C; 9.5 V < V<sub>CC1</sub> < 14 V; 5.0 V < V<sub>CC2</sub> < 16 V; DAC Code: V<sub>ID4</sub> = V<sub>ID2</sub> = V<sub>ID1</sub> = V<sub>ID0</sub> = 1; V<sub>ID3</sub> = 0; C<sub>V</sub>GATE(L) and C<sub>V</sub>GATE(H) = 1.0 nF; C<sub>OFF</sub> = 330 pF; C<sub>SS</sub> = 0.1 μF, unless otherwise specified.)

Characteristic	Test Conditions	Min	Typ	Max	Unit				
<b>PWM Comparator</b>									
Transient Response	V <sub>FFB</sub> = 0 to 5.0 V to V <sub>GATE(H)</sub> = 9.0 V to 1.0 V; V <sub>CC1</sub> = V <sub>CC2</sub> = 12 V	–	100	125	ns				
V <sub>FFB</sub> Bias Current	V <sub>FFB</sub> = 0 V	–	0.3	–	μA				
<b>DAC</b>									
Input Threshold	V <sub>ID0</sub> , V <sub>ID1</sub> , V <sub>ID2</sub> , V <sub>ID3</sub> , V <sub>ID4</sub>	1.00	1.25	2.40	V				
Input Pull Up Resistance	V <sub>ID0</sub> , V <sub>ID1</sub> , V <sub>ID2</sub> , V <sub>ID3</sub> , V <sub>ID4</sub>	25	50	110	kΩ				
Pull Up Voltage	–	4.85	5.00	5.15	V				
Accuracy (all codes except 11111, 10110, 10101, 10100, 10011, 10010, 10001, 10000, and 01111)	Measure V <sub>FB</sub> = COMP, CS5160: 25°C ≤ T <sub>J</sub> ≤ 85°C	–	–	1.0	%				
V <sub>ID4</sub>	V <sub>ID3</sub>	V <sub>ID2</sub>	V <sub>ID1</sub>	V <sub>ID0</sub>					
0	1	1	1	1	–	1.2896	1.3000	1.3104	V
0	1	1	1	0	–	1.3365	1.3500	1.3635	V
0	1	1	0	1	–	1.3860	1.4000	1.4140	V
0	1	1	0	0	–	1.4355	1.4500	1.4645	V
0	1	0	1	1	–	1.4850	1.5000	1.5150	V
0	1	0	1	0	–	1.5345	1.5500	1.5655	V
0	1	0	0	1	–	1.5840	1.6000	1.6160	V
0	1	0	0	0	–	1.6335	1.6500	1.6665	V
0	0	1	1	1	–	1.6830	1.7000	1.7170	V
0	0	1	1	0	–	1.7325	1.7500	1.7675	V
0	0	1	0	1	–	1.7820	1.8000	1.8180	V
0	0	1	0	0	–	1.8315	1.8500	1.8685	V
0	0	0	1	1	–	1.8810	1.9000	1.9190	V
0	0	0	1	0	–	1.9305	1.9500	1.9695	V
0	0	0	0	1	–	1.9800	2.0000	2.0200	V
0	0	0	0	0	–	2.0295	2.0500	2.0705	V
1	1	1	1	1	–	1.2191	1.2440	1.2689	V
1	1	1	1	0	–	2.0790	2.1000	2.1210	V
1	1	1	0	1	–	2.1780	2.2000	2.2220	V
1	1	1	0	0	–	2.2770	2.3000	2.3230	V
1	1	0	1	1	–	2.3760	2.4000	2.4240	V
1	1	0	1	0	–	2.4750	2.5000	2.5250	V
1	1	0	0	1	–	2.5740	2.6000	2.6260	V
1	1	0	0	0	–	2.6730	2.7000	2.7270	V
1	0	1	1	1	–	2.7720	2.8000	2.8280	V
1	0	1	1	0	–	2.8420	2.9000	2.9580	V
1	0	1	0	1	–	2.9400	3.0000	3.0600	V
1	0	1	0	0	–	3.0380	3.1000	3.1620	V

# CS5160

**ELECTRICAL CHARACTERISTICS (continued)** ( $0^{\circ}\text{C} < T_A < +70^{\circ}\text{C}$ ;  $0^{\circ}\text{C} < T_J < +85^{\circ}\text{C}$ ;  $9.5\text{ V} < V_{CC1} < 14\text{ V}$ ;  $5.0\text{ V} < V_{CC2} < 16\text{ V}$ ; DAC Code:  $V_{ID4} = V_{ID2} = V_{ID1} = V_{ID0} = 1$ ;  $V_{ID3} = 0$ ;  $C_{V_{GATE(L)}} \text{ and } C_{V_{GATE(H)}} = 1.0\text{ nF}$ ;  $C_{OFF} = 330\text{ pF}$ ;  $C_{SS} = 0.1\text{ }\mu\text{F}$ , unless otherwise specified.)

Characteristic					Test Conditions	Min	Typ	Max	Unit
<b>DAC</b>									
1	0	0	1	1	-	3.1360	3.2000	3.2640	V
1	0	0	1	0	-	3.2340	3.3000	3.3660	V
1	0	0	0	1	-	3.3320	3.4000	3.4680	V
1	0	0	0	0	-	3.4300	3.5000	3.5700	V

## $V_{GATE(H)}$ and $V_{GATE(L)}$

Out SOURCE Sat at 100 mA	Measure $V_{CC1} - V_{GATE(L)}$ ; $V_{CC2} - V_{GATE(H)}$	-	1.2	2.0	V
Out SINK Sat at 100 mA	Measure $V_{GATE(H)} - V_{PGnd}$ ; $V_{GATE(L)} - V_{PGnd}$	-	1.0	1.5	V
Out Rise Time	$1.0\text{ V} < V_{GATE(H)} < 9.0\text{ V}$ ; $1.0\text{ V} < V_{GATE(L)} < 9.0\text{ V}$ ; $V_{CC1} = V_{CC2} = 12\text{ V}$	-	30	50	ns
Out Fall Time	$9.0\text{ V} < V_{GATE(H)} > 1.0\text{ V}$ ; $9.0\text{ V} > V_{GATE(L)} > 1.0\text{ V}$ ; $V_{CC1} = V_{CC2} = 12\text{ V}$	-	30	50	ns
Delay $V_{GATE(H)}$ to $V_{GATE(L)}$	$V_{GATE(H)}$ falling to 1.0 V; $V_{CC1} = V_{CC2} = 8.0\text{ V}$ $C_{V_{GATE(H)}} = 3.3\text{ nF}$ ; $V_{GATE(L)}$ rising to 1.0 V	45	70	95	ns
Delay $V_{GATE(L)}$ to $V_{GATE(H)}$	$V_{GATE(L)}$ falling to 1.0 V; $V_{CC1} = V_{CC2} = 8.0\text{ V}$ $C_{V_{GATE(H)}} = 3.3\text{ nF}$ ; $V_{GATE(H)}$ rising to 1.0 V	45	70	95	ns
$V_{GATE(H)}$ , $V_{GATE(L)}$ Resistance	Resistor to LGnd. Note 3	20	50	100	k $\Omega$
$V_{GATE(H)}$ , $V_{GATE(L)}$ Schottky	LGnd to $V_{GATE(H)}$ @ 10 mA; LGnd to $V_{GATE(L)}$ @ 10 mA	-	600	800	mV

## Supply Current

$I_{CC1}$ No Switching	-	-	9.5	14.5	mA
$I_{CC2}$ No Switching	-	-	2.0	3.5	mA
Operating $I_{CC1}$	$V_{FB} = \text{COMP} = V_{FFB}$	-	9.0	14	mA
Operating $I_{CC2}$	$V_{FB} = \text{COMP} = V_{FFB}$	-	2.5	5.5	mA

## $C_{OFF}$

Normal Charge Time	$V_{FFB} = 1.5\text{ V}$ ; $V_{SS} = 5.0\text{ V}$	1.0	1.6	2.2	$\mu\text{s}$
Discharge Current	$C_{OFF}$ to 5.0 V; $V_{FB} > 1.0\text{ V}$	5.0	-	-	mA

## Time Out Timer

Time Out Time	$V_{FB} = V_{COMP}$ ; $V_{FFB} = 2.0\text{ V}$ ; Record $V_{GATE(H)}$ Pulse High Duration	10	30	65	$\mu\text{s}$
Fault Mode Duty Cycle	$V_{FFB} = 0\text{ V}$	35	50	70	%

3. Guaranteed by design, not 100% tested in production.

# CS5160

## PACKAGE PIN DESCRIPTION

查询CS5160GD16 供应商

PACKAGE PIN #	PIN SYMBOL	FUNCTION
<b>16 Lead SO Narrow</b>		
1, 2, 3, 4, 6	$V_{ID0}-V_{ID4}$	Voltage ID DAC input pins. These pins are internally pulled up to 5.0 V providing logic ones if left open. $V_{ID4}$ selects the DAC range. When $V_{ID4}$ is High (logic one), the DAC range is 2.10 V to 3.50 V with 100 mV increments. When $V_{ID4}$ is Low (logic zero), the DAC range is 1.30 V to 2.05 V with 50 mV increments. $V_{ID0} - V_{ID4}$ select the desired DAC output voltage. Leaving all 5 DAC input pins open results in a DAC output voltage of 1.2440 V, allowing for adjustable output voltage, using a traditional resistor divider.
5	SS	Soft Start Pin. A capacitor from this pin to LGnd in conjunction with internal 60 $\mu$ A current source provides Soft Start function for the controller. This pin disables fault detect function during Soft Start. When a fault is detected, the Soft Start capacitor is slowly discharged by internal 2.0 $\mu$ A current source setting the time out before trying to restart the IC. Charge/discharge current ratio of 30 sets the duty cycle for the IC when the regulator output is shorted.
7	$C_{OFF}$	A capacitor from this pin to ground sets the time duration for the on board one shot, which is used for the constant off time architecture.
8	$V_{FFB}$	Fast feedback connection to the PWM comparator. This pin is connected to the regulator output. The inner feedback loop terminates on time.
9	$V_{CC2}$	Boosted power for the high side gate driver.
10	$V_{GATE(H)}$	High FET driver pin capable of 1.5 A peak switching current. Internal circuit prevents $V_{GATE(H)}$ and $V_{GATE(L)}$ from being in high state simultaneously.
11	PGnd	High current ground for the IC. The MOSFET drivers are referenced to this pin. Input capacitor ground and the source of lower FET should be tied to this pin.
12	$V_{GATE(L)}$	Low FET driver pin capable of 1.5 A peak switching current.
13	$V_{CC1}$	Input power for the IC and low side gate driver.
14	LGnd	Signal ground for the IC. All control circuits are referenced to this pin.
15	COMP	Error amplifier compensation pin. A capacitor to ground should be provided externally to compensate the amplifier.
16	$V_{FB}$	Error amplifier DC feedback input. This is the master voltage feedback which sets the output voltage. This pin can be connected directly to the output or a remote sense trace.

查询"CS5160GD16"供应商

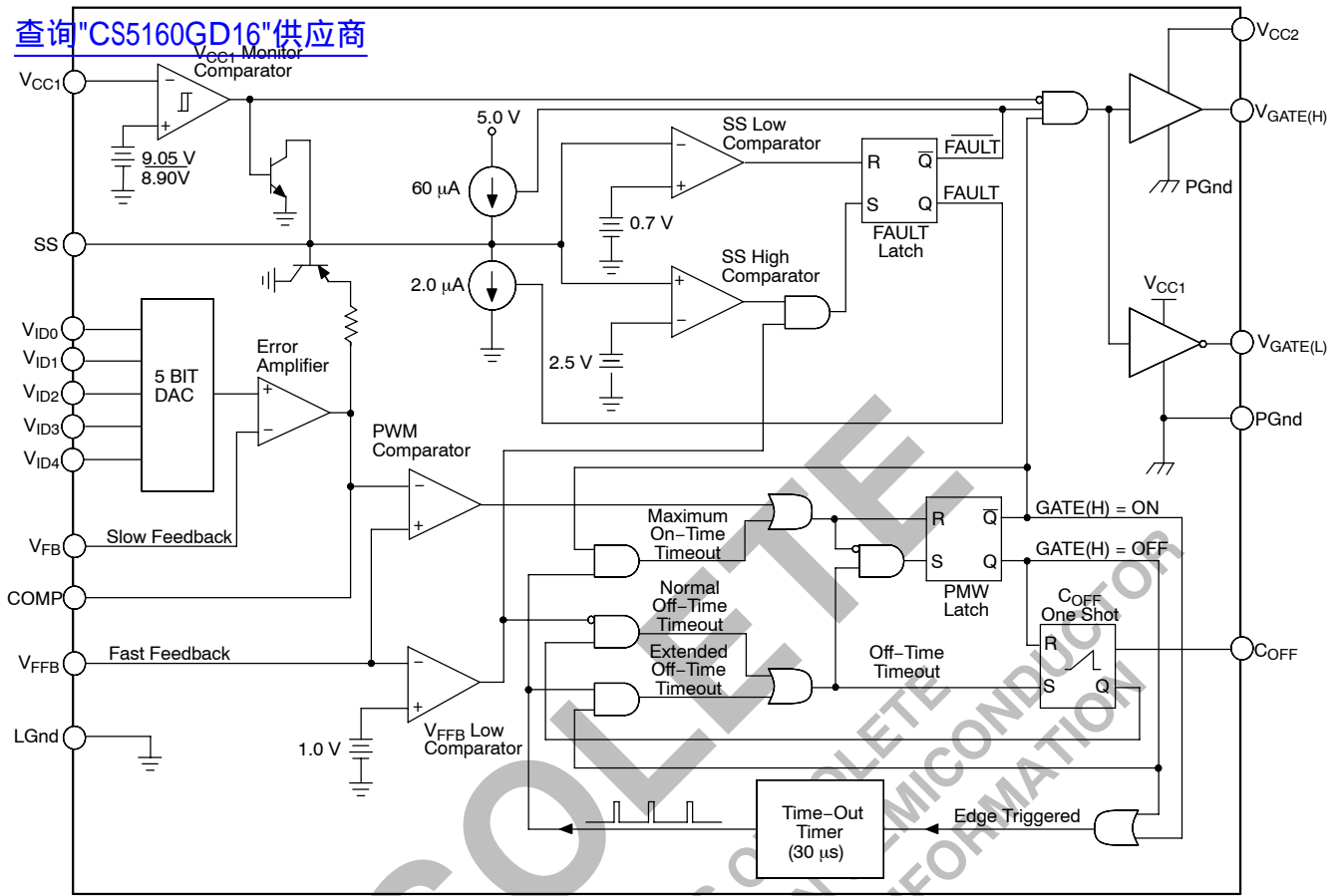

Figure 2. Block Diagram

APPLICATIONS INFORMATION

THEORY OF OPERATION

V<sup>2</sup> Control Method

The V<sup>2</sup> method of control uses a ramp signal that is generated by the ESR of the output capacitors. This ramp is proportional to the AC current through the main inductor and is offset by the value of the DC output voltage. This control scheme inherently compensates for variation in either line or load conditions, since the ramp signal is generated from the output voltage itself. This control scheme differs from traditional techniques such as voltage mode, which generates an artificial ramp, and current mode, which generates a ramp from inductor current.

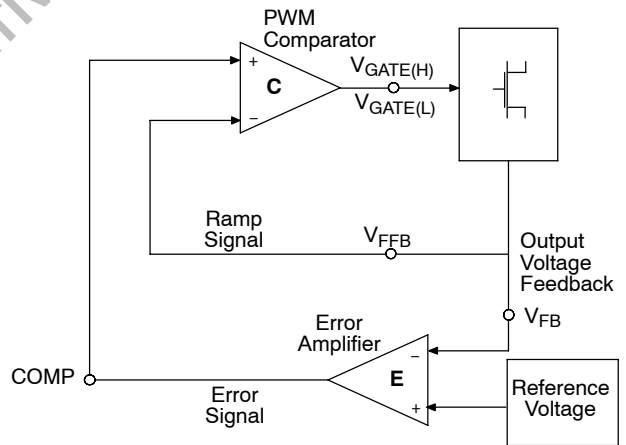

Figure 3. V<sup>2</sup> Control Diagram

The  $V^2$  control method is illustrated in Figure 3. The output voltage is used to generate both the error signal and the ramp signal. Since the ramp signal is simply the output voltage, it is affected by any change in the output regardless of the origin of that change. The ramp signal also contains the DC portion of the output voltage, which allows the control circuit to drive the main switch to 0% or 100% duty cycle as required.

A change in line voltage changes the current ramp in the inductor, affecting the ramp signal, which causes the  $V^2$  control scheme to compensate the duty cycle. Since the change in inductor current modifies the ramp signal, as in current mode control, the  $V^2$  control scheme has the same advantages in line transient response.

A change in load current will have an effect on the output voltage, altering the ramp signal. A load step immediately changes the state of the comparator output, which controls the main switch. Load transient response is determined only by the comparator response time and the transition speed of the main switch. The reaction time to an output load step has no relation to the crossover frequency of the error signal loop, as in traditional control methods.

The error signal loop can have a low crossover frequency, since transient response is handled by the ramp signal loop. The main purpose of this 'slow' feedback loop is to provide DC accuracy. Noise immunity is significantly improved, since the error amplifier bandwidth can be rolled off at a low frequency. Enhanced noise immunity improves remote sensing of the output voltage, since the noise associated with long feedback traces can be effectively filtered.

Line and load regulation are drastically improved because there are two independent voltage loops. A voltage mode controller relies on a change in the error signal to compensate for a deviation in either line or load voltage. This change in the error signal causes the output voltage to change corresponding to the gain of the error amplifier, which is normally specified as line and load regulation. A current mode controller maintains fixed error signal under deviation in the line voltage, since the slope of the ramp signal changes, but still relies on a change in the error signal for a deviation in load. The  $V^2$  method of control maintains a fixed error signal for both line and load variation, since the ramp signal is affected by both line and load.

#### Constant Off Time

To maximize transient response, the CS5160 uses a constant off time method to control the rate of output pulses. During normal operation, the off time of the high side switch is terminated after a fixed period, set by the  $C_{OFF}$  capacitor. To maintain regulation, the  $V^2$  control loop varies switch on time. The PWM comparator monitors the output voltage ramp, and terminates the switch on time.

Constant off time provides a number of advantages. Switch duty cycle can be adjusted from 0 to 100% on a pulse by pulse basis when responding to transient conditions. Both 0% and 100% duty cycle operation can be maintained for extended periods of time in response to load or line transients. PWM slope compensation to avoid sub-harmonic oscillations at high duty cycles is avoided.

Switch on time is limited by an internal 30  $\mu$ s timer, minimizing stress to the power components.

#### Programmable Output

The CS5160 is designed to provide two methods for programming the output voltage of the power supply. A five bit on board digital to analog converter (DAC) is used to program the output voltage within two different ranges. The first range is 2.10 V to 3.50 V in 100 mV steps, the second is 1.30 V to 2.05 V in 50 mV steps, depending on the digital input code. If all five bits are left open, the CS5160 enters adjust mode. In adjust mode, the designer can choose any output voltage by using resistor divider feedback to the  $V_{FB}$  and  $V_{FFB}$  pins, as in traditional controllers.

#### Start Up

Until the voltage on the  $V_{CC1}$  supply pin exceeds the 9.05 V monitor threshold, the Soft Start and gate pins are held low. The FAULT latch is reset (no Fault condition). The output of the error amplifier (COMP) is pulled up to 1.0 V by the comparator clamp. When the  $V_{CC1}$  pin exceeds the monitor threshold, the GATE(H) output is activated, and the Soft Start capacitor begins charging. The GATE(H) output will remain on, enabling the NFET switch, until terminated by either the PWM comparator, or the maximum on time timer.

If the maximum on time is exceeded before the regulator output voltage achieves the 1.0 V level, the pulse is terminated. The GATE(H) pin drives low, and the GATE(L) pin drives high for the duration of the extended off time. This time is set by the time out timer and is approximately equal to the maximum on time, resulting in a 50% duty cycle. The GATE(L) pin will then drive low, the GATE(H) pin will drive high, and the cycle repeats.

When regulator output voltage achieves the 1.0 V level present at the COMP pin, regulation has been achieved and normal off time will ensue. The PWM comparator terminates the switch on time, with off time set by the  $C_{OFF}$  capacitor. The  $V^2$  control loop will adjust switch duty cycle as required to ensure the regulator output voltage tracks the output of the error amplifier.

The Soft Start and COMP capacitors will charge to their final levels, providing a controlled turn on of the regulator output. Regulator turn on time is determined by the COMP capacitor charging to its final value. Its voltage is limited by



the Soft Start COMP clamp and the voltage on the Soft Start pin (see Figures 4 and 5).

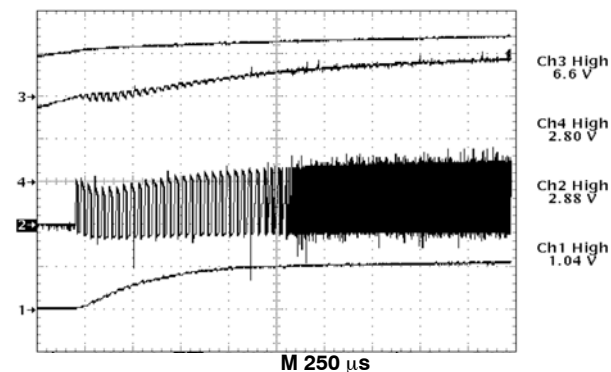

Trace 1– Regulator Output Voltage (1.0 V/div.)  
Trace 2– Inductor Switching Node (2.0 V/div.)  
Trace 3– 12 V Input (VCC1 and VCC2) (5.0 V/div.)  
Trace 4– 5.0 V Input (1.0 V/div.)

**Figure 4. CS5160 Startup in Response to Increasing 12 V and 5.0 V Input Voltages. Extended Off Time is Followed by Normal Off Time Operation when Output Voltage Achieves Regulation to the Error Amplifier Output**

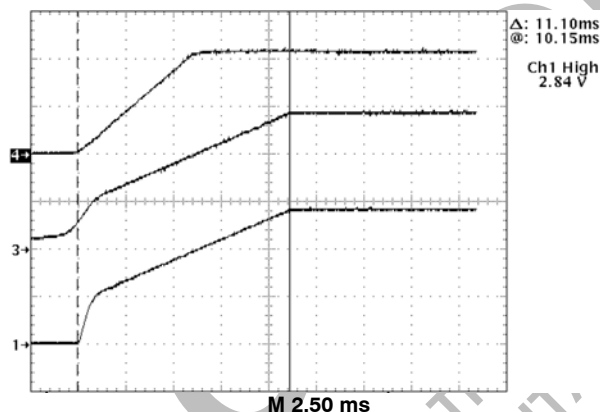

Trace 1– Regulator Output Voltage (1.0 V/div.)  
Trace 3– COMP Pin (error amplifier output) (1.0 V/div.)  
Trace 4– Soft Start Pin (2.0 V/div.)

**Figure 5. CS5160 Startup Waveforms**

If the input voltage rises quickly, or the regulator output is enabled externally, output voltage will increase to the level set by the error amplifier output more rapidly, usually within a couple of cycles (see Figure 6).

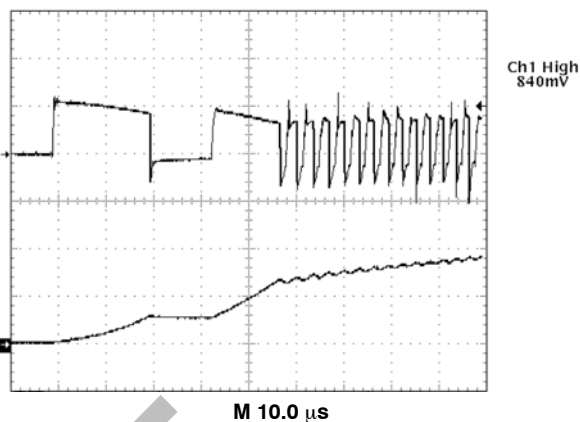

Trace 1– Regulator Output Voltage (5.0 V/div.)  
Trace 2– Inductor Switching Node (5.0 V/div.)

**Figure 6. CS5160 Enable Startup Waveforms**

**Normal Operation**

During normal operation, switch off time is constant and set by the  $C_{OFF}$  capacitor. Switch on time is adjusted by the  $V^2$  control loop to maintain regulation. This results in changes in regulator switching frequency, duty cycle, and output ripple in response to changes in load and line. Output voltage ripple will be determined by inductor ripple current working into the ESR of the output capacitors (see Figures 7 and 8).

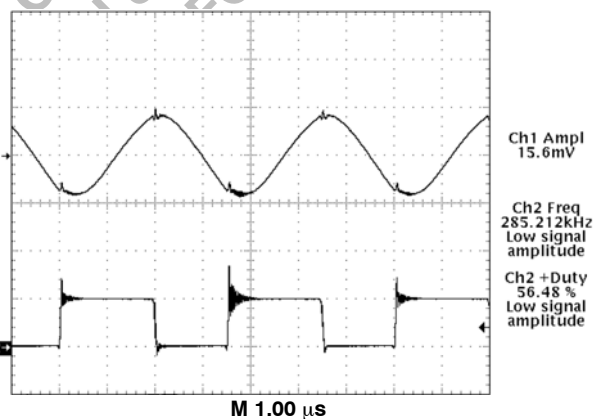

Trace 1– Regulator Output Voltage (10 mV/div.)  
Trace 2– Inductor Switching Node (5.0 V/div.)

**Figure 7. CS5160 Peak-to-Peak Ripple on  $V_{OUT} = 2.8 V$ ,  $I_{OUT} = 0.5 A$  (Light Load)**

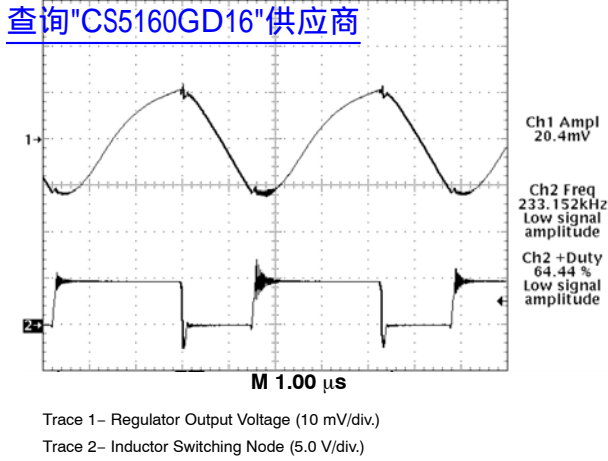

**Figure 8. CS5160 Peak-to-Peak Ripple on  $V_{OUT} = 2.8\text{ V}$ ,  $I_{OUT} = 13\text{ A}$  (Heavy Load)**

**Transient Response**

The CS5160  $V^2$  control loop's 100 ns reaction time provides unprecedented transient response to changes in input voltage or output current. Pulse by pulse adjustment of duty cycle is provided to quickly ramp the inductor current to the required level. Since the inductor current cannot be changed instantaneously, regulation is maintained by the output capacitor(s) during the time required to slew the inductor current.

For best transient response, a combination of a number of high frequency and bulk output capacitors are usually used.

If the maximum on time is exceeded while responding to a sudden increase in load current, a normal off time occurs to prevent saturation of the output inductor.

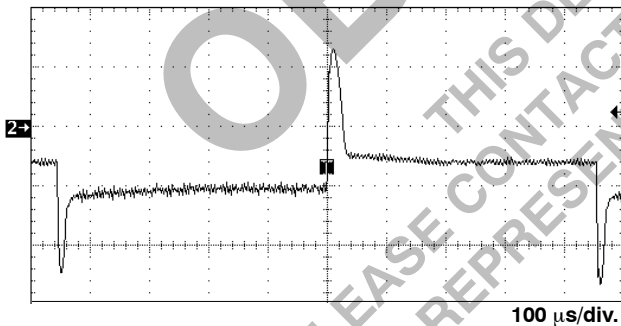

Trace 2- Regulator Output Voltage (output set for 1.55 V, 20 mV/div.)

**Figure 9. CS5160 Pentium® III Converter Output Voltage Response to a 12 A Load Pulse**

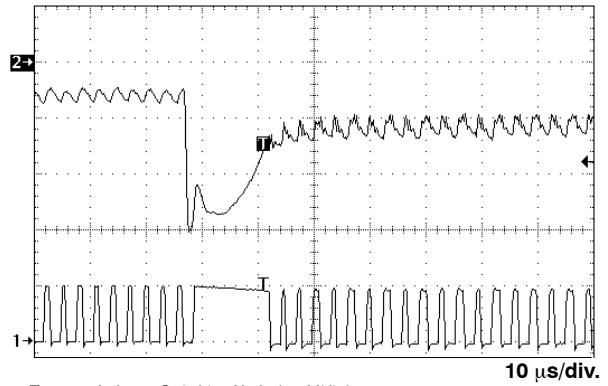

Trace 1- Inductor Switching Node (5.0 V/div.)  
Trace 2- Regulator Output Voltage (output set for 1.55 V, 20 mV/div.)

**Figure 10. CS5160 Pentium® III Converter Output Voltage Response to a 0 to 12 A Load Increase**

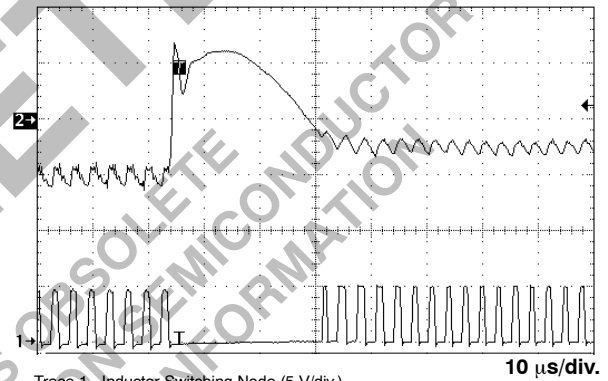

Trace 1- Inductor Switching Node (5 V/div.)  
Trace 2- Regulator Output Voltage (output set for 1.55 V, 20 mV/div.)

**Figure 11. CS5160 Pentium® III Converter Output Voltage Response to a 12 to 0 A Load Decrease**

**PROTECTION AND MONITORING FEATURES**

**$V_{CC1}$  Monitor**

To maintain predictable startup and shutdown characteristics an internal  $V_{CC1}$  monitor circuit is used to prevent the part from operating below 8.95 V minimum startup. The  $V_{CC1}$  monitor comparator provides hysteresis and guarantees a 8.80 V minimum shutdown threshold.

**Short Circuit Protection**

A lossless hiccup mode short circuit protection feature is provided, requiring only the Soft Start capacitor to implement. If a short circuit condition occurs ( $V_{FFB} < 1.0\text{ V}$ ), the  $V_{FFB}$  low comparator sets the FAULT

latch. This causes the top MOSFET to shut off, disconnecting the regulator from its input voltage. The Soft Start capacitor is then slowly discharged by a 2.0  $\mu$ A current source until it reaches its lower 0.7 V threshold. The regulator will then attempt to restart normally, operating in its extended off time mode with a 50% duty cycle, while the Soft Start capacitor is charged with a 60  $\mu$ A charge current.

If the short circuit condition persists, the regulator output will not achieve the 1.0 V low  $V_{FFB}$  comparator threshold before the Soft Start capacitor is charged to its upper 2.5 V threshold. If this happens the cycle will repeat itself until the short is removed. The Soft Start charge/discharge current ratio sets the duty cycle for the pulses (2.0  $\mu$ A/60  $\mu$ A = 3.3%), while actual duty cycle is half that due to the extended off time mode (1.65%).

This protection feature results in less stress to the regulator components, input power supply, and PC board traces than occurs with constant current limit protection (see Figures 12 and 13).

If the short circuit condition is removed, output voltage will rise above the 1.0 V level, preventing the FAULT latch from being set, allowing normal operation to resume.

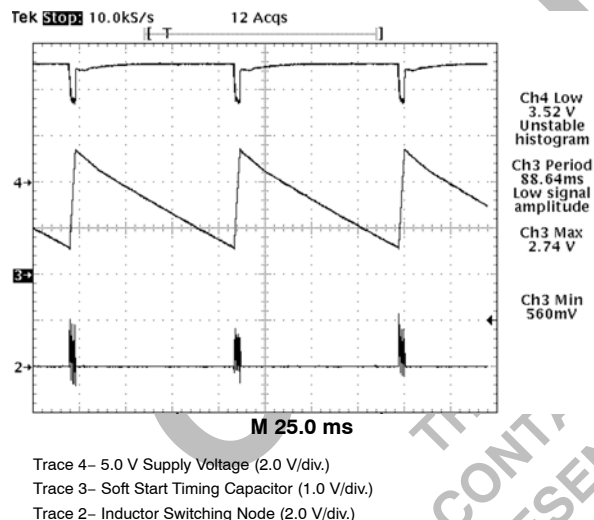

**Figure 12. CS5160 Hiccup Mode Short Circuit Protection. Gate Pulses are Delivered While the Soft Start Capacitor Charges, and Cease During Discharge**

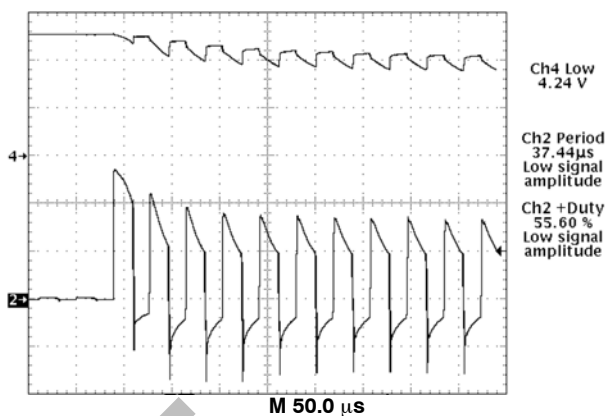

**Figure 13. CS5160 Startup with Regulator Output Shorted**

**Overvoltage Protection**

Overvoltage protection (OVP) is provided as result of the normal operation of the  $V^2$  control topology and requires no additional external components. The control loop responds to an overvoltage condition within 100 ns, causing the top MOSFET to shut off, disconnecting the regulator from its input voltage. The bottom MOSFET is then activated, resulting in a “crowbar” action to clamp the output voltage and prevent damage to the load (see Figures 14 and 15). The regulator will remain in this state until the overvoltage condition ceases or the input voltage is pulled low. The bottom FET and board trace must be properly designed to implement the OVP function.

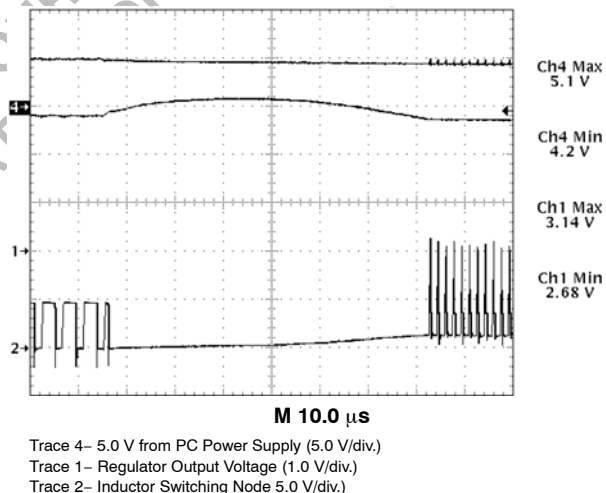

**Figure 14. CS5160 OVP Response to an Input-to-Output Short Circuit by Immediately Providing 0% Duty Cycle, Crow-Barring the Input Voltage to Ground**

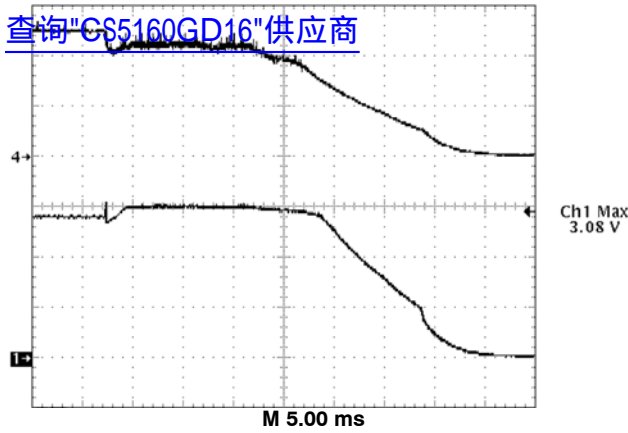

Trace 4– 5.0 V from PC Power Supply (5.0 V/div.)  
Trace 1– Regulator Output Voltage (1.0 V/div.)

**Figure 15. CS5160 OVP Response to an Input-to-Output Short Circuit by Pulling the Input Voltage to Ground**

**External Output Enable Circuit**

On/off control of the regulator can be implemented through the addition of two additional discrete components (see Figure 14). This circuit operates by pulling the Soft Start pin high, and the V<sub>FFB</sub> pin low, emulating a short circuit condition.

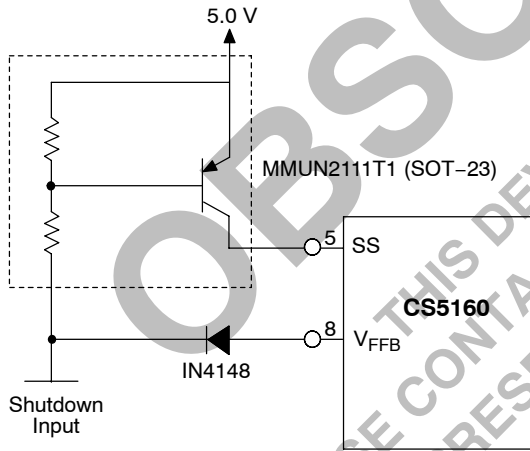

**Figure 16. Implementing Shutdown with the CS5160**

**External Power Good Circuit**

An optional Power Good signal can be generated through the use of four additional external components (see Figure 17). The threshold voltage of the Power Good signal can be adjusted per the following equation:

$$V_{\text{Power Good}} = \frac{(R1 + R2) \times 0.65 \text{ V}}{R2}$$

This circuit provides an open collector output that drives the Power Good output to ground for regulator voltages less than V<sub>Power Good</sub>.

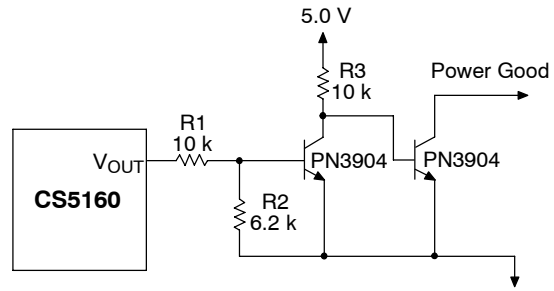

**Figure 17. Implementing Power Good with the CS5160**

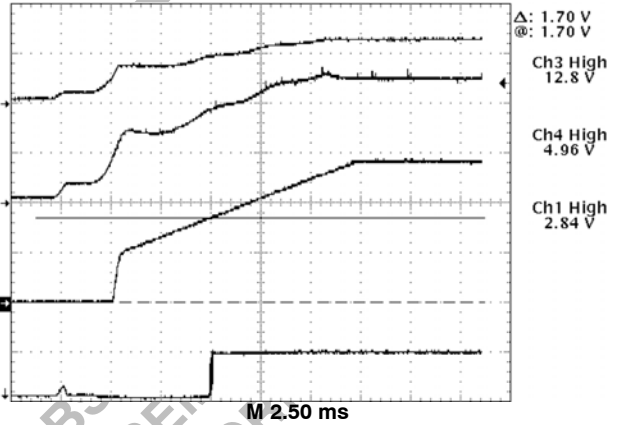

Trace 3 – 12 V Input (V<sub>CC1</sub>) and (V<sub>CC2</sub>) (10 V/div.)  
Trace 4 – 5.0 V Input (2.0 V/div.)  
Trace 1 – Regulator Output Voltage (1.0 V/div.)  
Trace 2 – Power Good Signal (2.0 V/div.)

**Figure 18. CS5160 During Power Up. Power Good Signal is Activated when Output Voltage Reaches 1.70 V**

**Slope Compensation**

The V<sup>2</sup> control method uses a ramp signal, generated by the ESR of the output capacitors, that is proportional to the ripple current through the inductor. To maintain regulation, the V<sup>2</sup> control loop monitors this ramp signal, through the PWM comparator, and terminates the switch on-time.

The stringent load transient requirements of modern microprocessors require the output capacitors to have very low ESR. The resulting shallow slope presented to the PWM comparator, due to the very low ESR, can lead to pulse width jitter and variation caused by both random or synchronous noise.

Adding slope compensation to the control loop, avoids erratic operation of the PWM circuit, particularly at lower duty cycles and higher frequencies, where there is not enough ramp signal, and provides a more stable switchpoint.

The scheme that prevents that switching noise prematurely triggers the PWM circuit consists of adding a positive voltage slope to the output of the Error Amplifier (COMP pin) during an off-time cycle.

The circuit that implements this function is shown in Figure 19.

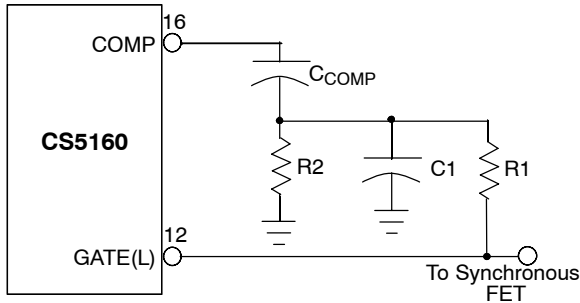

**Figure 19. Small RC Filter Provides the Proper Voltage Ramp at the Beginning of each On-Time Cycle**

The ramp waveform is generated through a small RC filter that provides the proper voltage ramp at the beginning of each on-time cycle. The resistors R1 and R2 in the circuit of Figure 14 form a voltage divider from the GATE(L) output, superimposing a small artificial ramp on the output of the error amplifier. It is important that the series combination R1/R2 is high enough in resistance not to load down and negatively affect the slew rate on the GATE(L) pin.

**Selecting External Components**

The CS5160 can be used with a wide range of external power components to optimize the cost and performance of a particular design. The following information can be used as general guidelines to assist in their selection.

**NFET Power Transistors**

Both logic level and standard MOSFETs can be used. The reference designs derive gate drive from the 12 V supply which is generally available in most computer systems and utilize logic level MOSFETs. Multiple MOSFETs may be paralleled to reduce losses and improve efficiency and thermal management.

Voltage applied to the MOSFET gates depends on the application circuit used. Both upper and lower gate driver outputs are specified to drive to within 1.5 V of ground when in the low state and to within 2.0 V of their respective bias supplies when in the high state. In practice, the MOSFET gates will be driven rail to rail due to overshoot caused by the capacitive load they present to the controller IC. For the typical application where  $V_{CC1} = V_{CC2} = 12\text{ V}$  and 5.0 V is used as the source for the regulator output current, the following gate drive is provided;

$V_{GATE(H)} = 12\text{ V} - 5.0\text{ V} = 7.0\text{ V}$ ,  $V_{GATE(L)} = 12\text{ V}$   
(see Figure 20.)

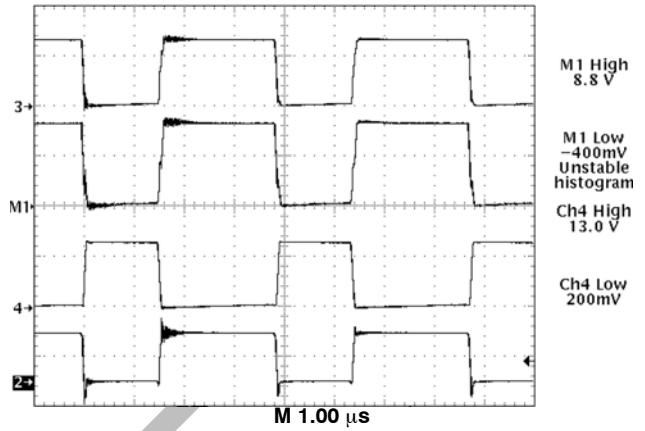

Trace 3 =  $V_{GATE(H)}$  (10 V/div.)  
Math 1 =  $V_{GATE(H)} - 5.0\text{ V}_{IN}$   
Trace 4 =  $V_{GATE(L)}$  (10 V/div.)  
Trace 2 = Inductor Switching Nodes (5.0 V/div.)

**Figure 20. CS5160 Gate Drive Waveforms Depicting Rail to Rail Swing**

The most important aspect of MOSFET performance is  $R_{DS(ON)}$ , which effects regulator efficiency and MOSFET thermal management requirements.

The power dissipated by the MOSFETs may be estimated as follows;

Switching MOSFET:

$$\text{Power} = I_{LOAD}^2 \times R_{DS(ON)} \times \text{duty cycle}$$

Synchronous MOSFET:

$$\text{Power} = I_{LOAD}^2 \times R_{DS(ON)} \times (1 - \text{duty cycle})$$

Duty Cycle =

$$\frac{V_{OUT} + (I_{LOAD} \times R_{DS(ON)} \text{ OF SYNCH FET})}{\left[ V_{IN} + (I_{LOAD} \times R_{DS(ON)} \text{ OF SYNCH FET}) \right] - (I_{LOAD} \times R_{DS(ON)} \text{ OF SWITCH FET})}$$

**Off Time Capacitor ( $C_{OFF}$ )**

The  $C_{OFF}$  timing capacitor sets the regulator off time:

$$T_{OFF} = C_{OFF} \times 4848.5$$

The preceding equations for duty cycle can also be used to calculate the regulator switching frequency and select the  $C_{OFF}$  timing capacitor:

$$C_{OFF} = \frac{\text{Period} \times (1 - \text{duty cycle})}{4848.5}$$

where:

$$\text{Period} = \frac{1}{\text{switching frequency}}$$

### Schottky Diode for Synchronous MOSFET

A Schottky diode may be placed in parallel with the synchronous MOSFET to conduct the inductor current upon turn off of the switching MOSFET to improve efficiency. For a design operating at 200 kHz or so, the low non-overlap time combined with Schottky forward recovery time may make the benefits of this device not worth the additional expense (see Figure 8, channel 2). The power dissipation in the synchronous MOSFET due to body diode conduction can be estimated by the following equation:

$$\text{Power} = V_{BD} \times I_{LOAD} \times \text{conduction time} \times \text{switching frequency}$$

Where  $V_{BD}$  = the forward drop of the MOSFET body diode. For the CS5160 demonstration board as shown in Figure 8;

$$\text{Power} = 1.6 \text{ V} \times 13 \text{ A} \times 100 \text{ ns} \times 233 \text{ kHz} = 0.48 \text{ W}$$

This is only 1.3% of the 36.4 W being delivered to the load.

### Input and Output Capacitors

These components must be selected and placed carefully to yield optimal results. Capacitors should be chosen to provide acceptable ripple on the input supply lines and regulator output voltage. Key specifications for input capacitors are their ripple rating, while ESR is important for output capacitors. For best transient response, a combination of low value/high frequency and bulk capacitors placed close to the load will be required.

### Output Inductor

The inductor should be selected based on its inductance, current capability, and DC resistance. Increasing the inductor value will decrease output voltage ripple, but degrade transient response.

## THERMAL MANAGEMENT

### Thermal Considerations for Power MOSFETs and Diodes

In order to maintain good reliability, the junction temperature of the semiconductor components should be kept to a maximum of 150°C or lower. The thermal impedance (junction to ambient) required to meet this requirement can be calculated as follows:

$$\text{Thermal Impedance} = \frac{T_{JUNCTION(MAX)} - T_{AMBIENT}}{\text{Power}}$$

A heatsink may be added to TO-220 components to reduce their thermal impedance. A number of PC board layout techniques such as thermal vias and additional copper foil area can be used to improve the power handling capability of surface mount components.

### EMI Management

As a consequence of large currents being turned on and off at high frequency, switching regulators generate noise as a consequence of their normal operation. When designing for compliance with EMI/EMC regulations, additional components may be added to reduce noise emissions. These components are not required for regulator operation and experimental results may allow them to be eliminated. The input filter inductor may not be required because bulk filter and bypass capacitors, as well as other loads located on the board will tend to reduce regulator di/dt effects on the circuit board and input power supply. Placement of the power component to minimize routing distance will also help to reduce emissions.

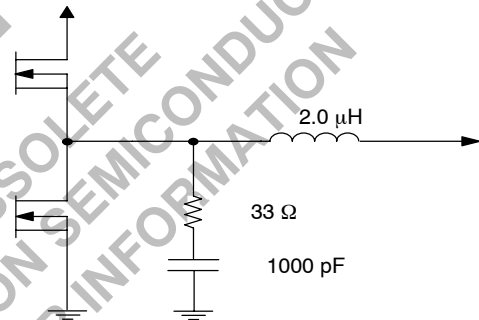

Figure 21. Filter Components

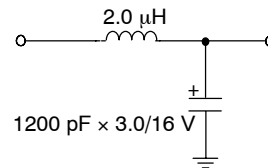

Figure 22. Input Filter

**Layout Guidelines**

[查询"CS5160GD16"供应商](#)

- Place 12 V filter capacitor next to the IC and connect capacitor ground to pin 11 (PGnd).
- Connect pin 11 (PGnd) with a separate trace to the ground terminals of the 5.0 V input capacitors.
- Place fast feedback filter capacitor next to pin 8 ( $V_{FFB}$ ) and connect its ground terminal with a separate, wide trace directly to pin 14 (LGnd).
- Connect the ground terminals of the Compensation capacitor directly to the ground of the fast feedback filter capacitor to prevent common mode noise from effecting the PWM comparator.
- Place the output filter capacitor(s) as close to the load as possible and connect the ground terminal to pin 14 (LGnd).
- Connect the  $V_{FB}$  pin directly to the load with a separate trace (remote sense).
- Place 5.0 V input capacitors close to the switching MOSFET and synchronous MOSFET.

Route gate drive signals  $V_{GATE(H)}$  (pin 10) and  $V_{GATE(L)}$  (pin 12 when used) with traces that are a minimum of 0.025 inches wide.

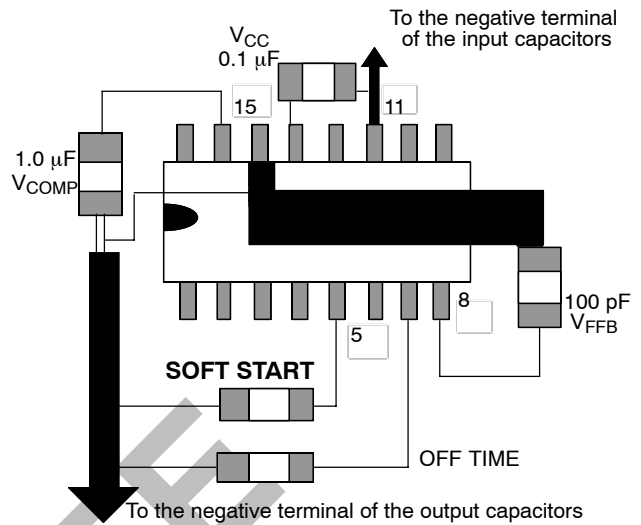

**Figure 23. Layout Guidelines**

OBSOLETE

THIS DEVICE IS OBSOLETE  
PLEASE CONTACT YOUR ON SEMICONDUCTOR  
REPRESENTATIVE FOR INFORMATION

[查询"CS5160GD16"供应商](#)

ADDITIONAL APPLICATION DIAGRAMS

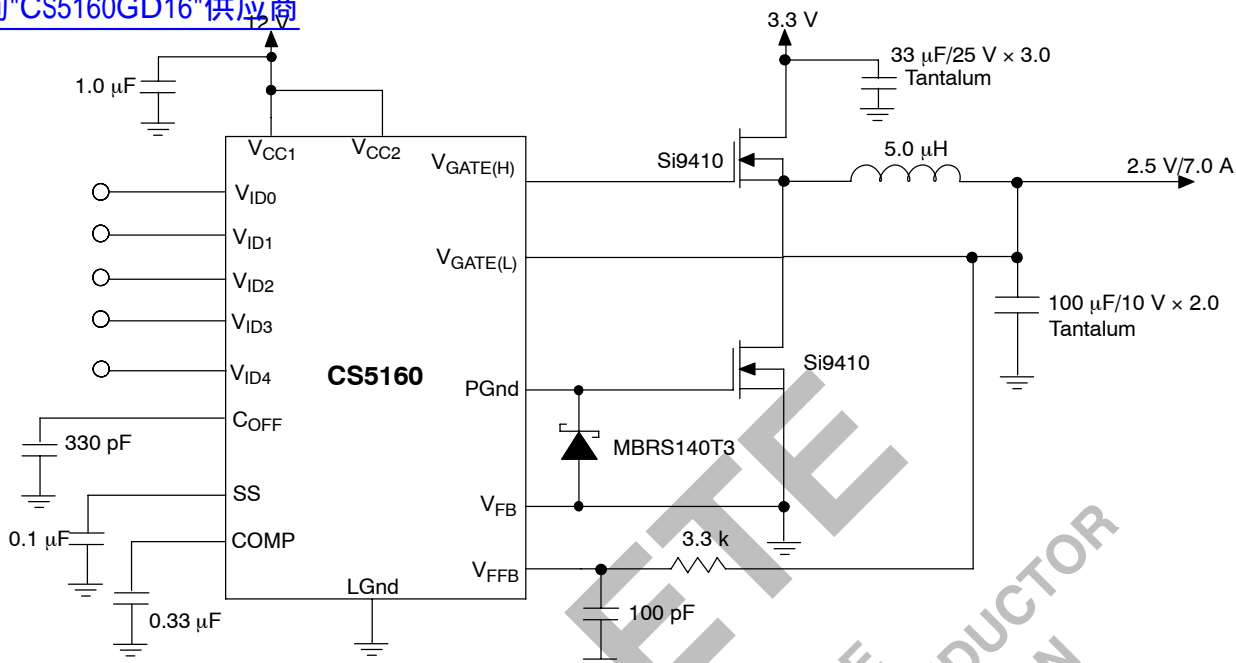

Figure 24. 3.3 V to 2.5 V/7.0 A Converter with 12 V Bias

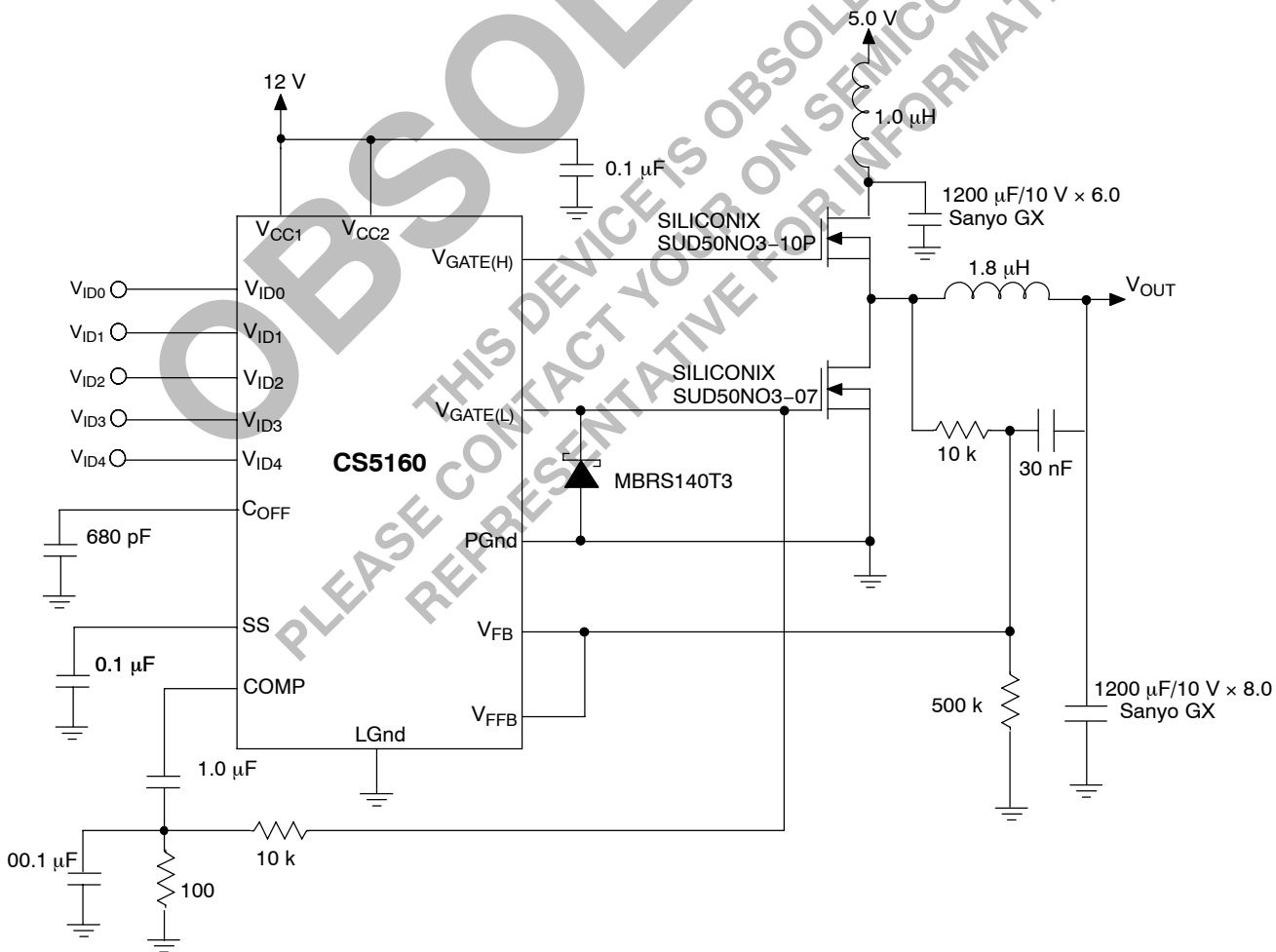

Figure 25. Pentium®III Converter with Slope Compensation and Adaptive Voltage Positioning



# CS5160

查询"CS5160GD16"供应商

## PACKAGE DIMENSIONS

SO-16  
D SUFFIX  
CASE 751B-05  
ISSUE J

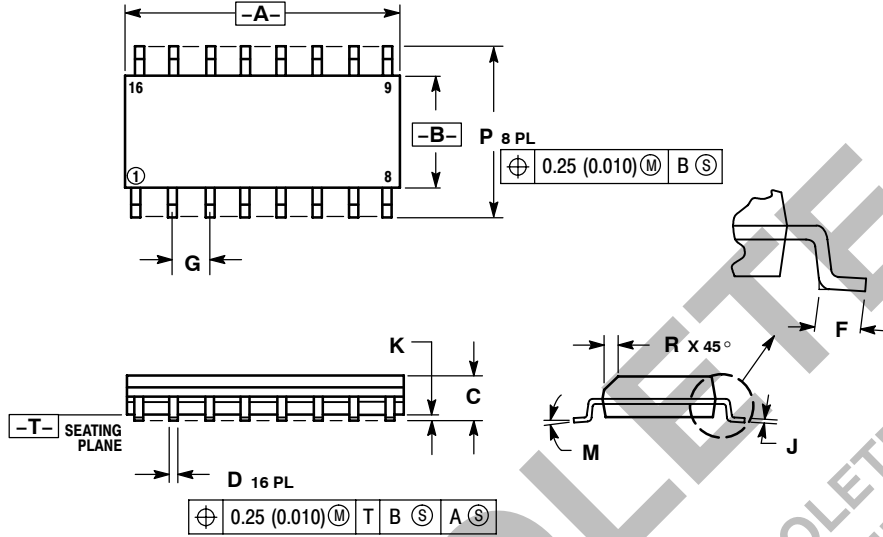

### NOTES:

1. DIMENSIONING AND TOLERANCING PER ANSI Y14.5M, 1982.
2. CONTROLLING DIMENSION: MILLIMETER.
3. DIMENSIONS A AND B DO NOT INCLUDE MOLD PROTRUSION.
4. MAXIMUM MOLD PROTRUSION 0.15 (0.006) PER SIDE.
5. DIMENSION D DOES NOT INCLUDE DAMBAR PROTRUSION. ALLOWABLE DAMBAR PROTRUSION SHALL BE 0.127 (0.005) TOTAL IN EXCESS OF THE D DIMENSION AT MAXIMUM MATERIAL CONDITION.

DIM	MILLIMETERS		INCHES	
	MIN	MAX	MIN	MAX
A	9.80	10.00	0.386	0.393
B	3.80	4.00	0.150	0.157
C	1.35	1.75	0.054	0.068
D	0.35	0.49	0.014	0.019
F	0.40	1.25	0.016	0.049
G	1.27 BSC		0.050 BSC	
J	0.19	0.25	0.008	0.009
K	0.10	0.25	0.004	0.009
M	0°	7°	0°	7°
P	5.80	6.20	0.229	0.244
R	0.25	0.50	0.010	0.019

### PACKAGE THERMAL DATA

Parameter		16 Lead SO Narrow	Unit
$R_{\theta JC}$	Typical	28	°C/W
$R_{\theta JA}$	Typical	115	°C/W

[查询"CS5160GD16"供应商](#)

**OBSOLETE**  
 THIS DEVICE IS OBSOLETE  
 PLEASE CONTACT YOUR ON SEMICONDUCTOR  
 REPRESENTATIVE FOR INFORMATION

V<sup>2</sup> is a trademark of Switch Power, Inc.  
 Pentium is a registered trademark of Intel Corporation.

**ON Semiconductor** and  are trademarks of Semiconductor Components Industries, LLC (SCILLC). SCILLC reserves the right to make changes without further notice to any products herein. SCILLC makes no warranty, representation or guarantee regarding the suitability of its products for any particular purpose, nor does SCILLC assume any liability arising out of the application or use of any product or circuit, and specifically disclaims any and all liability, including without limitation special, consequential or incidental damages. "Typical" parameters which may be provided in SCILLC data sheets and/or specifications can and do vary in different applications and actual performance may vary over time. All operating parameters, including "Typicals" must be validated for each customer application by customer's technical experts. SCILLC does not convey any license under its patent rights nor the rights of others. SCILLC products are not designed, intended, or authorized for use as components in systems intended for surgical implant into the body, or other applications intended to support or sustain life, or for any other application in which the failure of the SCILLC product could create a situation where personal injury or death may occur. Should Buyer purchase or use SCILLC products for any such unintended or unauthorized application, Buyer shall indemnify and hold SCILLC and its officers, employees, subsidiaries, affiliates, and distributors harmless against all claims, costs, damages, and expenses, and reasonable attorney fees arising out of, directly or indirectly, any claim of personal injury or death associated with such unintended or unauthorized use, even if such claim alleges that SCILLC was negligent regarding the design or manufacture of the part. SCILLC is an Equal Opportunity/Affirmative Action Employer.

## PUBLICATION ORDERING INFORMATION

### Literature Fulfillment:

Literature Distribution Center for ON Semiconductor  
 P.O. Box 5163, Denver, Colorado 80217 USA  
**Phone:** 303-675-2175 or 800-344-3860 Toll Free USA/Canada  
**Fax:** 303-675-2176 or 800-344-3867 Toll Free USA/Canada  
**Email:** ONlit@hibbertco.com

**N. American Technical Support:** 800-282-9855 Toll Free USA/Canada

**JAPAN:** ON Semiconductor, Japan Customer Focus Center  
 4-32-1 Nishi-Gotanda, Shinagawa-ku, Tokyo, Japan 141-0031  
**Phone:** 81-3-5740-2700  
**Email:** r14525@onsemi.com

**ON Semiconductor Website:** <http://onsemi.com>

For additional information, please contact your local  
 Sales Representative.