

POWER TRANSISTORS

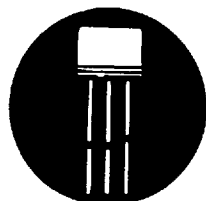

TO-5

TYPE NO.	PT @ 25°C Watts	MAXIMUM RATINGS				hfe @				Sat Voltages		Test Conditions		I _{EBO} ma
		BV _{CBO}	BV _{CEO}	BV _{EB0}	I _c	hfe		I _c	V _{CE}	V _{CE}	V _{BE}	I _c	I _B	
		V	V	V	A	MIN	MAX	A	V	V	V	A	A	
2N1116	.6	60	60	6	.8	40	150	.5	6	5.0	4.0	.5	.05	100
2N1117	.6	60	60	6	.8	40	150	.2	6	4.0	3.0	.2	.02	100
2N1479	5.0	60	40	12	1.5	20	60	.2	4	1.4	3.0	.2	.02	10
2N1480	5.0	100	55	12	1.5	20	60	.2	4	1.4	3.0	.2	.02	10
2N1481	5.0	60	40	12	1.5	35	100	.2	4	1.4	3.0	.2	.01	10
2N1482	5.0	100	55	12	1.5	35	100	.2	4	1.4	3.0	.1	.01	10
2N1700	5.0	60	40	6	1.0	20	80	.1	4	1.0	2.5	.5	.01	25
2N2033	8.75	80	60	10	3.0	20	60	.5	4	.4	1.2	1.0	.05	50
2N2034	8.75	80	60	10	3.0	20	60	1.0	4	.3	1.2	1.0	.10	50
2N2858	8.75	100	80	10	3.0	20	60	1.0	3	.3	1.3	1.0	.10	50
2N2859	8.75	120	100	10	3.0	20	60	1.0	3	.3	1.3	1.0	.10	50
2N2911	8.75	150	125	10	3.0	20	60	1.0	2	.3	1.2	1.0	.10	25

POWER TRANSISTORS



TO-8

TYPE NO.	PT @ 25°C Watts	MAXIMUM RATINGS				hfe @				Sat Voltages		Test Conditions		I _{EBO} ma
		BV _{CBO}	BV _{CEO}	BV _{EB0}	I _c	hfe		I _c	V _{CE}	V _{CE}	V _{BE}	I _c	I _B	
		V	V	V	A	MIN	MAX	A	V	V	V	A	A	
2N1067	5	60	30	12	.5	15	75	.2	4	2.0	3.0	.2	.02	100
2N1068	10	60	30	12	1.5	15	75	.75	4	2.0	3.0	.75	.10	100
2N1483	25	60	40	12	3.0	20	60	.75	4	2.0	3.5	.75	.075	15
2N1484	25	100	55	12	3.0	20	60	.75	4	2.0	3.5	.75	.075	15
2N1485	25	60	40	12	3.0	35	100	.75	4	.75	2.5	.75	.04	15
2N1486	25	100	55	12	3.0	35	100	.75	4	.75	2.5	.75	.04	15
2N1701	25	40	40	6	2.5	20	80	.3	4	1.5	3.0	.3	.03	50
2N2035	25	60	60	10	3.0	20	60	1.5	4	1.0	1.8	1.5	.15	50
2N2304	25	40	40	6	3.0	20	80	.3	4	.9	3.0	.3	.06	50
2N2308	25	80	80	12	3.0	20	60	1.0	4	1.0	2.0	1.0	.10	15

Solid Power Corporation

CASE OUTLINES

查询"2N1067"供应商

TO-3

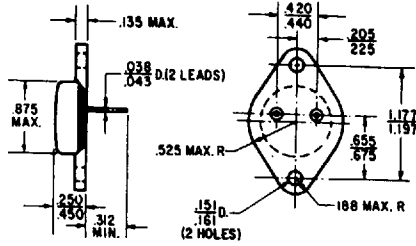

TO-57

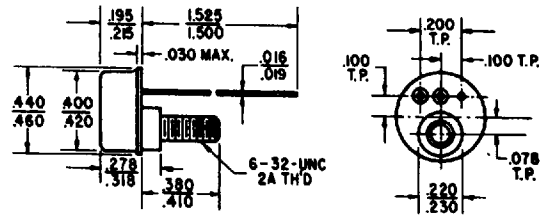

TO-8

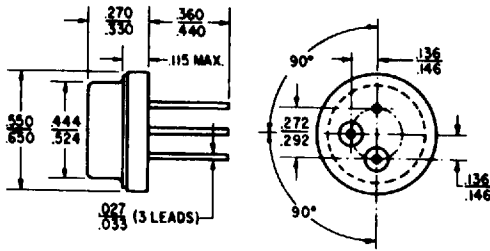

TO-59

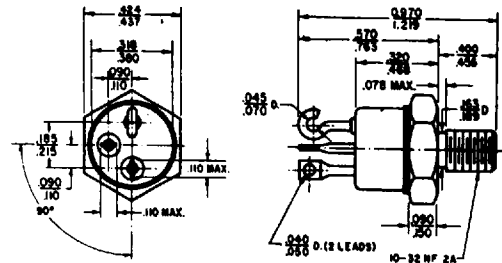

TO-5

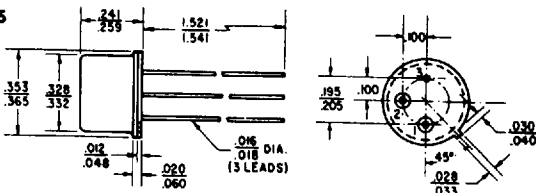

TO-81

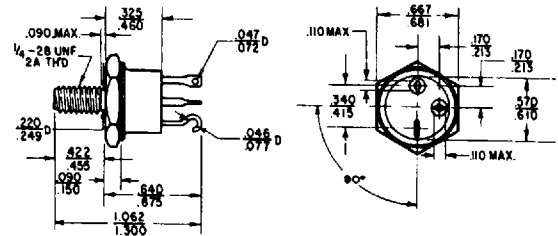

TO-36

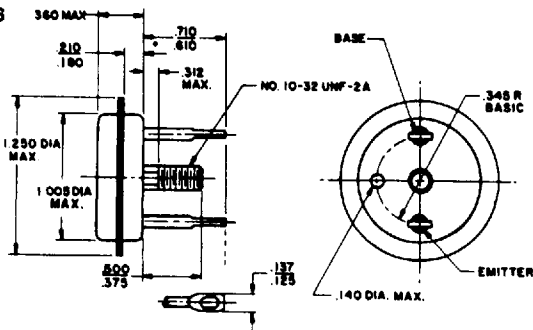

TO-63

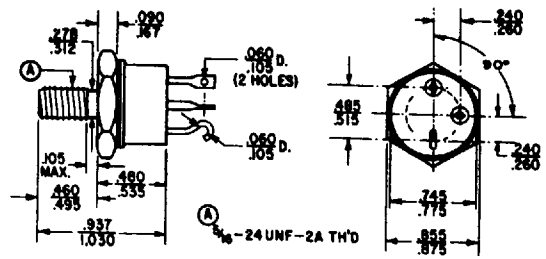

TO-53

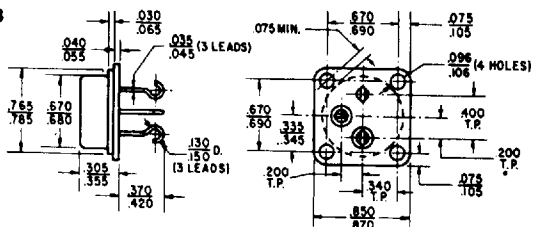

TO-82

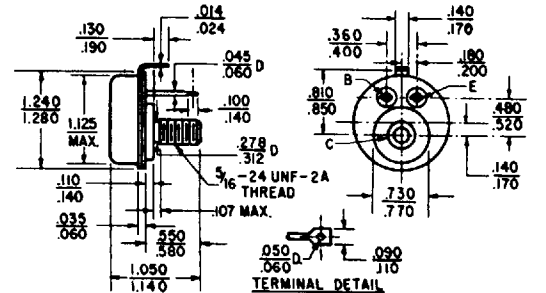

TO-114

