

LMV651/LMV652/LMV654

12 MHz, Low Voltage, Low Power Amplifiers

General Description

National's LMV651/LMV652/LMV654 are high performance, low power operational amplifier ICs implemented with National's advanced VIP50 process. This family of parts features 12 MHz of bandwidth while consuming only 116 μA of current, which is an exceptional bandwidth to power ratio in this op amp class. The LMV651/LMV652/LMV654 are unity gain stable and provide an excellent solution for general purpose amplification in low voltage, low power applications.

This family of low voltage, low power amplifiers provides superior performance and economy in terms of power and space usage. These op amps have a maximum input offset voltage of 1.5 mV, a rail-to-rail output stage and an input common-mode voltage range that includes ground. The LMV651/LMV652/LMV654 provide a PSRR of 95 dB, a CMRR of 100 dB and a total harmonic distortion (THD) of 0.003% at 1 kHz frequency and 2 k Ω load.

The operating supply voltage range for this family of parts is from 2.7V and 5.5V. These op amps can operate over a wide temperature range (-40°C to 125°C) making them ideal for automotive applications, sensor applications and portable equipment applications. The LMV651 is offered in the ultra tiny 5-Pin SC70 and 5-Pin SOT-23 package. The LMV652 is offered in an 8-Pin MSOP package. The LMV654 is offered in a 14-Pin TSSOP package.

Features

(Typical 5V supply, unless otherwise noted.)

- Guaranteed 3.0V and 5.0V performance
- Low power supply current
 - LMV651 116 μA
 - LMV652 118 μA per amplifier
 - LMV654 122 μA per amplifier
- High unity gain bandwidth 12 MHz
- Max input offset voltage 1.5 mV
- CMRR 100 dB
- PSRR 95 dB
- Input referred voltage noise 17 nV/ $\sqrt{\text{Hz}}$
- Output swing with 2 k Ω load 120 mV from rail
- Total harmonic distortion 0.003% @ 1 kHz, 2 k Ω
- Temperature range -40°C to 125°C

Applications

- Portable equipment
- Automotive
- Battery powered systems
- Sensors and Instrumentation

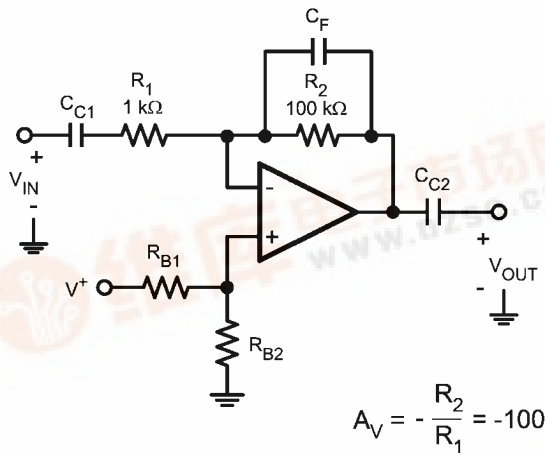

High Gain Wide Bandwidth Inverting Amplifier

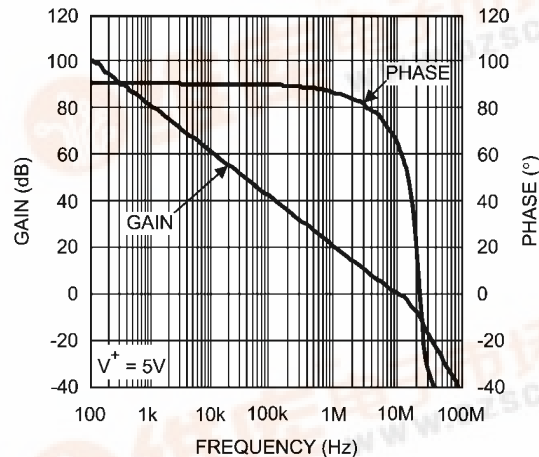

Open Loop Gain and Phase vs. Frequency

Absolute Maximum Ratings (Note 1)

查询"LMV652"供应商

If Military/Aerospace specified devices are required, please contact the National Semiconductor Sales Office/Distributors for availability and specifications.

ESD Tolerance (Note 2)

Human Body Model	2000V
Machine Model	100V
Differential Input V_{ID}	$\pm 0.3V$
Supply Voltage ($V_S = V^+ - V^-$)	6V
Input/Output Pin Voltage	$V^+ + 0.3V, V^- - 0.3V$
Storage Temperature Range	$-65^\circ C$ to $150^\circ C$
Junction Temperature (Note 3)	$150^\circ C$
Soldering Information	

Infrared or Convection (20 sec)	$235^\circ C$
Wave Soldering Lead Temp (10 sec)	$260^\circ C$

Operating Ratings (Note 1)

Temperature Range (Note 3)	$-40^\circ C$ to $125^\circ C$
Supply Voltage	2.7V to 5.5V
Package Thermal Resistance (θ_{JA})(Note 3)	
5-Pin SC70	$456^\circ C/W$
5-Pin SOT-23	$234^\circ C/W$
8-Pin MSOP	$234^\circ C/W$
14-Pin TSSOP	$160^\circ C/W$

3V DC Electrical Characteristics

Unless otherwise specified, all limits are guaranteed for $T_A = 25^\circ C$, $V^+ = 3V$, $V^- = 0V$, $V_O = V_{CM} = V^+/2$, and $R_L > 1 M\Omega$. **Bold-face** limits apply at the temperature extremes.

Symbol	Parameter	Conditions	Min (Note 5)	Typ (Note 4)	Max (Note 5)	Units
V_{OS}	Input Offset Voltage			0.1	± 1.5 2.7	mV
TC V_{OS}	Input Offset Average Drift			6.6		$\mu V/^\circ C$
I_B	Input Bias Current	(Note 6)		80	120	nA
I_{OS}	Input Offset Current			2.2	15	nA
CMRR	Common Mode Rejection Ratio	$0 \leq V_{CM} \leq 2.0 V$	87 80	100		dB
PSRR	Power Supply Rejection Ratio	$3.0 \leq V^+ \leq 5V, V_{CM} = 0.5$	87 81	95		dB
		$2.7 \leq V^+ \leq 5.5V, V_{CM} = 0.5$	87 81	95		
CMVR	Input Common-Mode Voltage Range	CMRR ≥ 75 dB CMRR ≥ 60 dB	0 0		2.1 2.1	V
A_{VOL}	Large Signal Voltage Gain	$0.3 \leq V_O \leq 2.7, R_L = 2 k\Omega$ to $V^+/2$	80 76	85		dB
		$0.3 \leq V_O \leq 2.7, R_L = 10 k\Omega$ to $V^+/2$	86 83	93		
		$0.4 \leq V_O \leq 2.6, R_L = 10 k\Omega$ to $V^+/2$				
V_O	Output Swing High	$R_L = 2 k\Omega$ to $V^+/2$		80	95 120	mV from rail
		$R_L = 10 k\Omega$ to $V^+/2$		45	50 60	
	Output Swing Low	$R_L = 2 k\Omega$ to $V^+/2$		95	110 125	
		$R_L = 10 k\Omega$ to $V^+/2$		60	65 75	
I_{SC}	Maximum Continuous Output Current	Sourcing (Note 8)		17		mA
		Sinking (Note 8)		25		
I_S	Supply Current per Amplifier	LMV651		115	140	μA
		LMV652		118	175	
		LMV654		122		
SR	Slew Rate	$A_V = +1$, 10% to 90% (Note 7)		3.0		V/ μs
GBW	Gain Bandwidth Product			12		MHz

Symbol	Parameter	Conditions	Min (Note 5)	Typ (Note 4)	Max (Note 5)	Units
e_n	Input-Referred Voltage Noise	$f = 100 \text{ kHz}$		17		$\text{nV}/\sqrt{\text{Hz}}$
		$f = 1 \text{ kHz}$		17		
i_n	Input-Referred Current Noise	$f = 100 \text{ kHz}$		0.1		$\text{pA}/\sqrt{\text{Hz}}$
		$f = 1 \text{ kHz}$		0.15		
THD	Total Harmonic Distortion	$f = 1 \text{ kHz}, A_V = 2, R_L = 2 \text{ k}\Omega$		0.003		%

5V DC Electrical Characteristics

Unless otherwise specified, all limits are guaranteed for $T_J = 25^\circ\text{C}$, $V_+ = 5\text{V}$, $V_- = 0\text{V}$, $V_O = V_{CM} = V_+/2$, and $R_L > 1 \text{ M}\Omega$. **Boldface** limits apply at the temperature extremes.

Symbol	Parameter	Conditions	Min (Note 5)	Typ (Note 4)	Max (Note 5)	Units
V_{OS}	Input Offset Voltage			0.1	± 1.5 2.7	mV
TC V_{OS}	Input Offset Average Drift			6.6		$\mu\text{V}/^\circ\text{C}$
I_B	Input Bias Current	(Note 6)		80	120	nA
I_{OS}	Input Offset Current			2.2	15	nA
CMRR	Common Mode Rejection Ratio	$0 \leq V_{CM} \leq 4.0 \text{ V}$	90 83	100		dB
PSRR	Power Supply Rejection Ratio	$3\text{V} \leq V_+ \leq 5\text{V}, V_{CM} = 0.5\text{V}$	87 81	95		dB
		$2.7\text{V} \leq V_+ \leq 5.5\text{V}, V_{CM} = 0.5\text{V}$	87 81	95		
CMVR	Input Common-Mode Voltage Range	CMRR $\geq 80 \text{ dB}$ CMRR $\geq 68 \text{ dB}$	0 0		4.1 4.1	V
A_{VOL}	Large Signal Voltage Gain	$0.3 \leq V_O \leq 4.7\text{V}, R_L = 2 \text{ k}\Omega \text{ to } V_+/2$ $0.4 \leq V_O \leq 4.6, R_L = 2 \text{ k}\Omega \text{ to } V_+/2$	79 76	84		dB
		$0.3 \leq V_O \leq 4.7\text{V}, R_L = 10 \text{ k}\Omega \text{ to } V_+/2$ $0.4 \leq V_O \leq 4.6, R_L = 10 \text{ k}\Omega \text{ to } V_+/2$	87 84	94		
V_O	Output Swing High	$R_L = 2 \text{ k}\Omega \text{ to } V_+/2$		120	140 185	mV from rail
		$R_L = 10 \text{ k}\Omega \text{ to } V_+/2$		75	90 120	
	Output Swing Low	$R_L = 2 \text{ k}\Omega \text{ to } V_+/2$		110	130 150	
		$R_L = 10 \text{ k}\Omega \text{ to } V_+/2$		70	80 95	
I_{SC}	Maximum Continuous Output Current	Sourcing (Note 8)		18.5		mA
		Sinking (Note 8)		25		
I_S	Supply Current per Amplifier	LMV651		116	140	μA
		LMV652		118	175	
		LMV654		122		
SR	Slew Rate	$A_V = +1, V_O = 1 V_{PP}$ 10% to 90% (Note 7)		3.0		$\text{V}/\mu\text{s}$
GBW	Gain Bandwidth Product			12		MHz
e_n	Input-Referred Voltage Noise	$f = 100 \text{ kHz}$		17		$\text{nV}/\sqrt{\text{Hz}}$
		$f = 1 \text{ kHz}$		17		
i_n	Input-Referred Current Noise	$f = 100 \text{ kHz}$		0.1		$\text{pA}/\sqrt{\text{Hz}}$
		$f = 1 \text{ kHz}$		0.15		
THD	Total Harmonic Distortion	$f = 1 \text{ kHz}, A_V = 2, R_L = 2 \text{ k}\Omega$		0.003		%

查询LMV652 供应商

Note 1: Absolute Maximum Ratings indicate limits beyond which damage to the device may occur. Operating Ratings indicate conditions for which the device is intended to be functional, but specific performance is not guaranteed. For guaranteed specifications and the test conditions, see the Electrical Characteristics Tables.

Note 2: Human Body Model, applicable std. MIL-STD-883, Method 3015.7. Machine Model, applicable std. JESD22-A115-A (ESD MM std. of JEDEC). Field-Induced Charge-Device Model, applicable std. JESD22-C101-C (ESD FICDM std. of JEDEC).

Note 3: The maximum power dissipation is a function of $T_{J(MAX)}$, θ_{JA} , and T_A . The maximum allowable power dissipation at any ambient temperature is $P_D = (T_{J(MAX)} - T_A) / \theta_{JA}$. All numbers apply for packages soldered directly onto a PC board.

Note 4: Typical values represent the most likely parametric norm as determined at the time of characterization. Actual typical values may vary over time and will also depend on the application and configuration. The typical values are not tested and are not guaranteed on shipped production material.

Note 5: Limits are 100% production tested at 25°C. Limits over the operating temperature range are guaranteed through correlations using Statistical Quality Control (SQC) method.

Note 6: Positive current corresponds to current flowing into the device.

Note 7: Slew rate is the average of the rising and falling slew rates.

Note 8: The part is not short circuit protected and is not recommended for operation with low resistive loads. Typical sourcing and sinking output current curves are provided in the Typical Performance Characteristics and should be consulted before designing for heavy loads.

Connection Diagrams

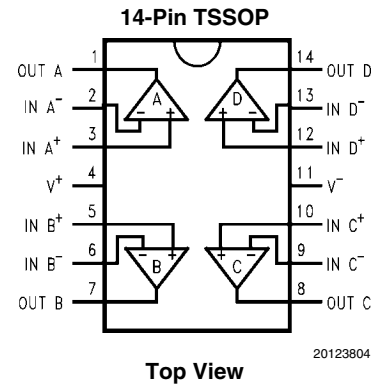
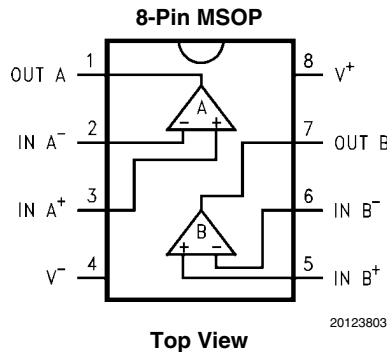
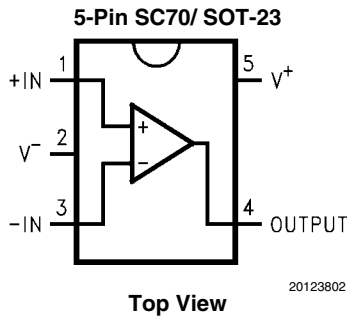

Ordering Information

Package	Part Number	Package Marking	Transport Media	NSC Drawing
5-Pin SC70	LMV651MG	A93	1k Units Tape and Reel	MAA05A
	LMV651MGX		3k Units Tape and Reel	
5-Pin SOT-23	LMV651MF	AY2A	1k Units Tape and Reel	MF05A
	LMV651MFX		3k Units Tape and Reel	
8-Pin MSOP	LMV652MM	AB3A	1k Units Tape and Reel	MUA08A
	LMV652MMX		3.5k Units Tape and Reel	
14-Pin TSSOP	LMV654MT	LMV654MT	94 Units/Rail	MTC14
	LMV654MTX		2.5k Units Tape and Reel	

Typical Performance Characteristics

Unless otherwise specified, $T_A = 25^\circ\text{C}$, $V_S = 5\text{V}$, $V_{+} = 5\text{V}$, $V_{-} = 0\text{V}$, $V_{CM} = 0\text{V}$

查询"LMV652"供应商

Supply Current vs. Supply Voltage (LMV651)

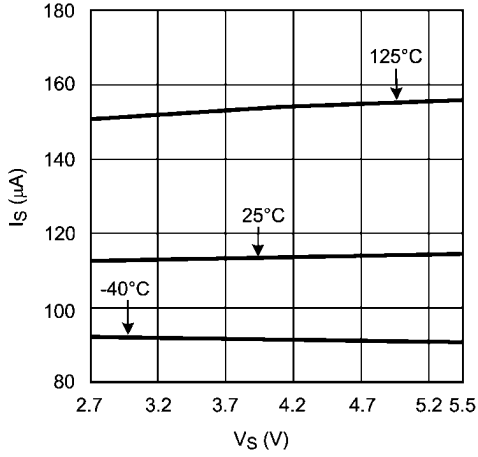

20123834

Supply Current per Channel vs. Supply Voltage (LMV652)

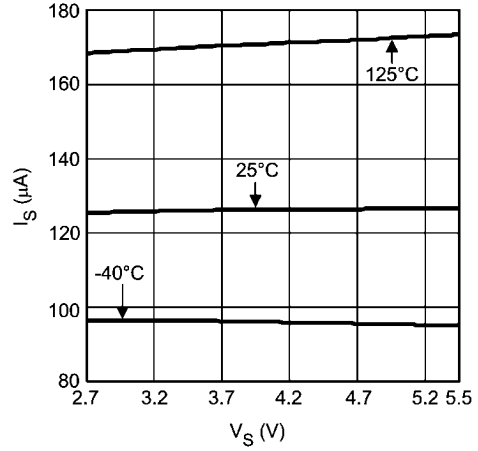

20123865

Supply Current per Channel vs. Supply Voltage (LMV654)

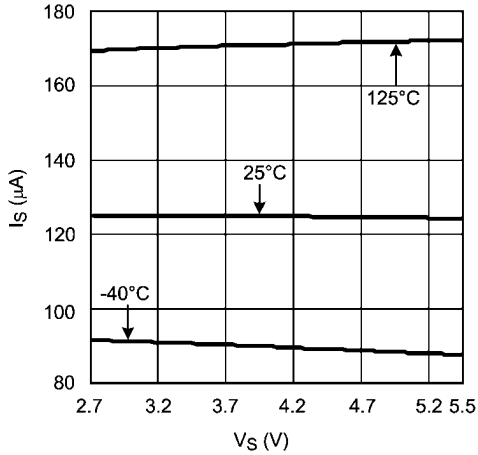

20123864

V_{OS} vs. V_{CM}

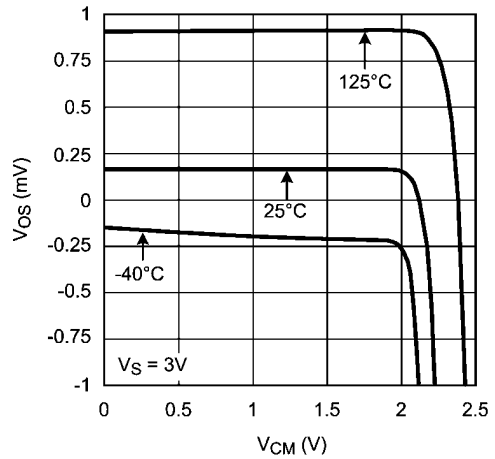

20123825

V_{OS} vs. V_{CM}

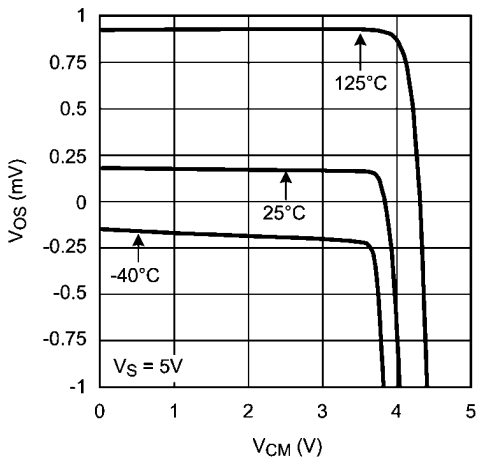

20123826

V_{OS} vs. Supply Voltage

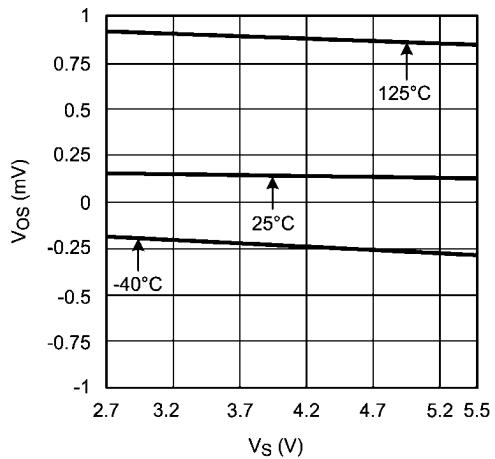

20123821

查询"LMV652"供应商

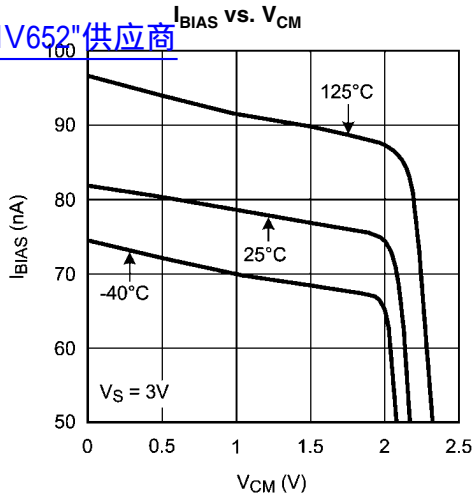

20123823

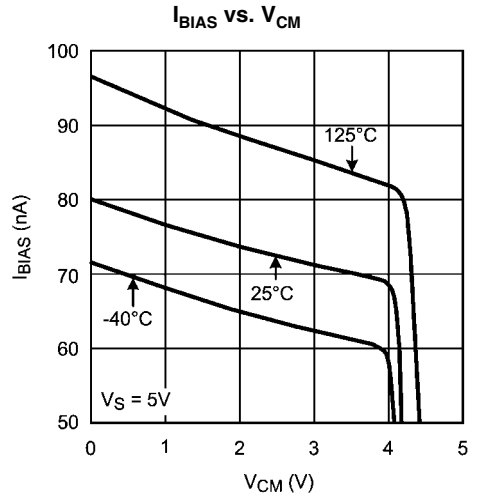

20123824

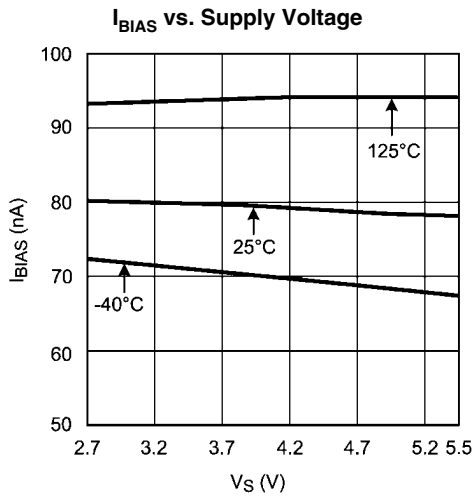

20123822

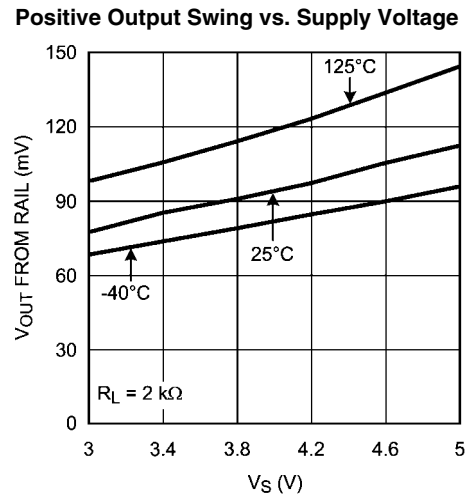

20123828

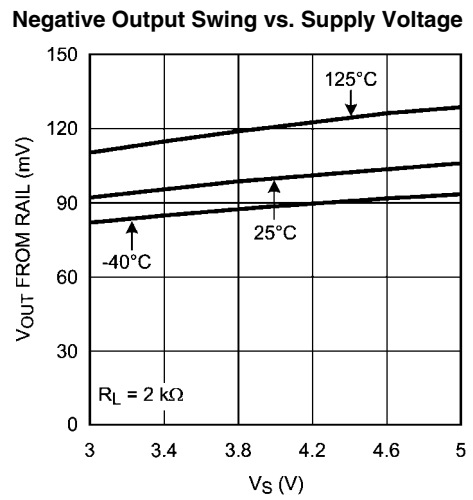

20123829

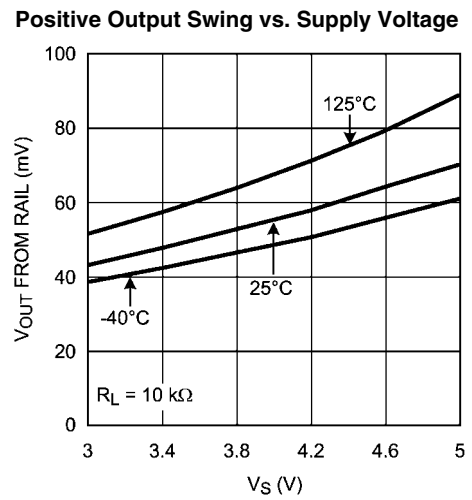

20123827

Negative Output Swing vs. Supply Voltage

查询"LMV652"供应商

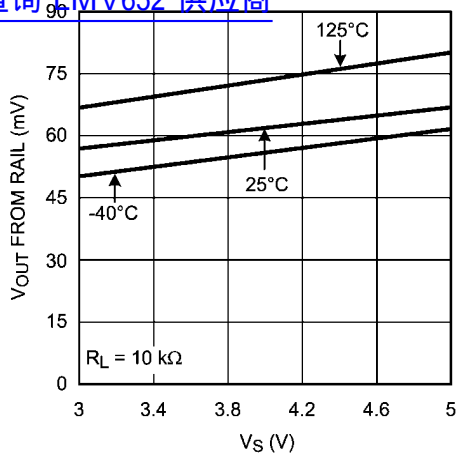

20123830

Sourcing Current vs. Output Voltage

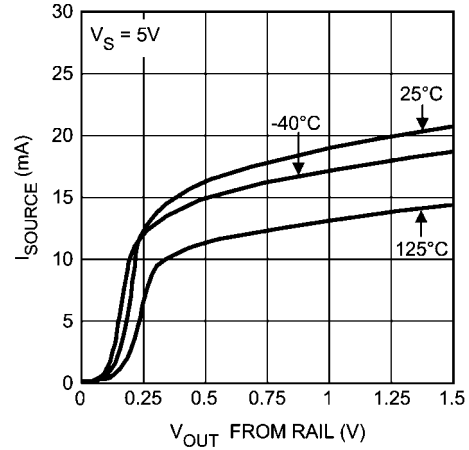

20123832

Sinking Current vs. Output Voltage (LMV651)

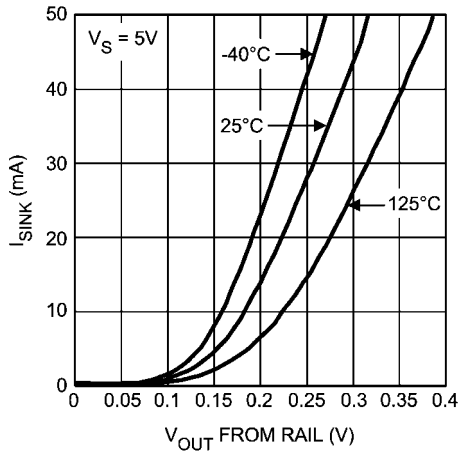

20123833

Sinking Current vs. Output Voltage (LMV652)

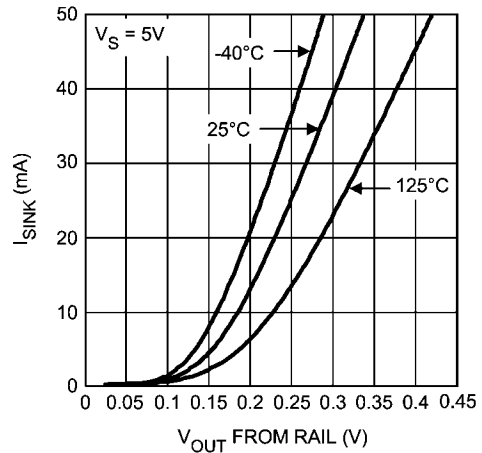

20123866

Sinking Current vs. Output Voltage (LMV654)

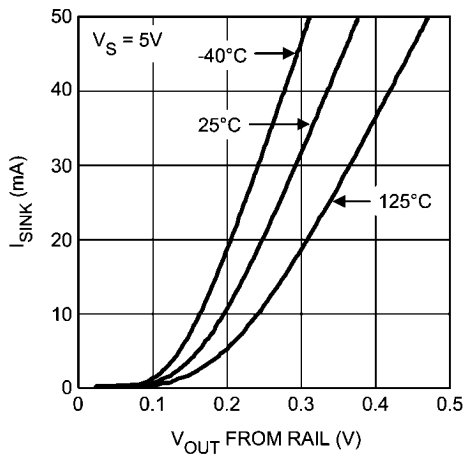

20123863

Open Loop Gain and Phase with Capacitive Load

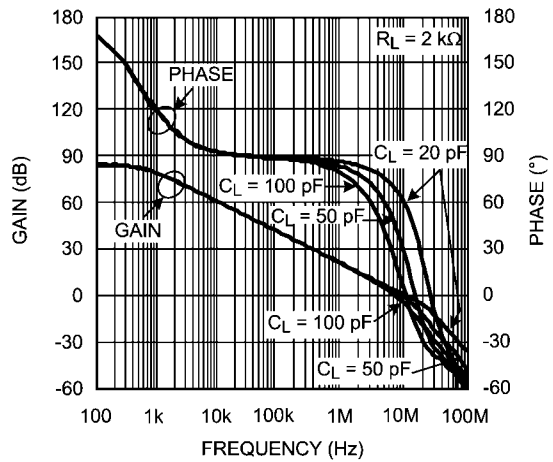

20123811

Open Loop Gain and Phase with Resistive Load

查询"LMV652"供应商

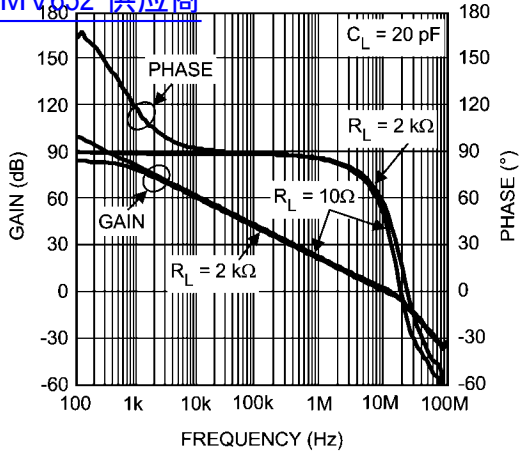

20123812

Phase Margin vs. Capacitive Load (Stability)

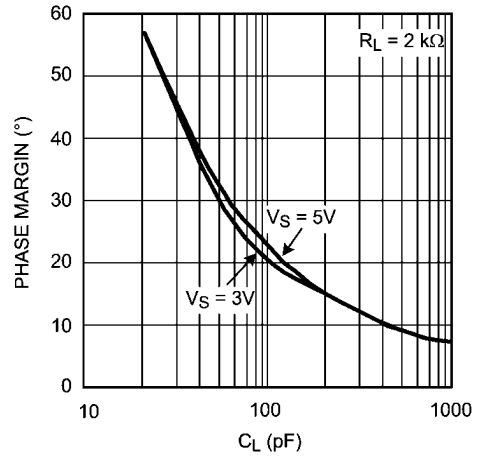

20123813

Input Referred Voltage Noise vs. Frequency

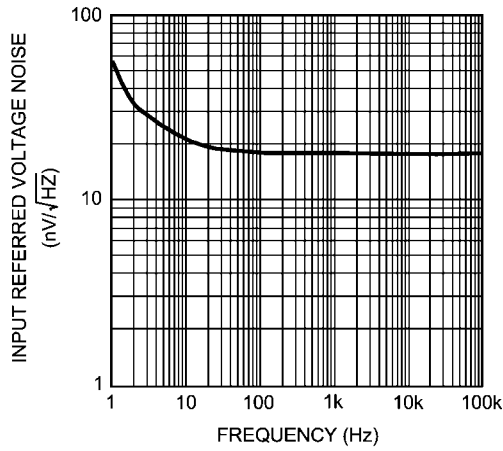

20123814

Input Referred Current Noise vs. Frequency

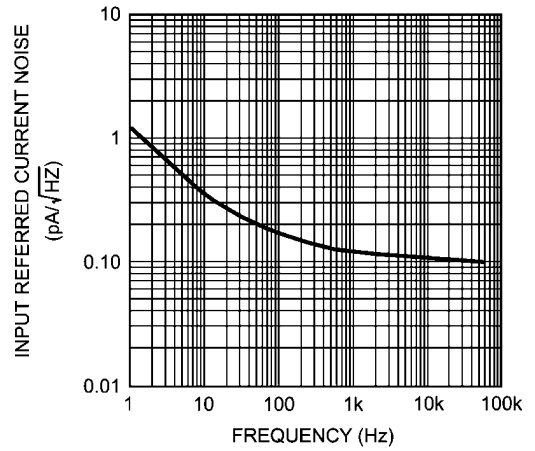

20123815

Slew Rate vs. Supply Voltage

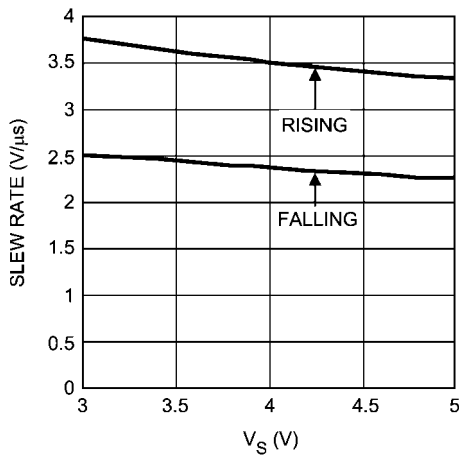

20123816

THD+N vs. VOUT

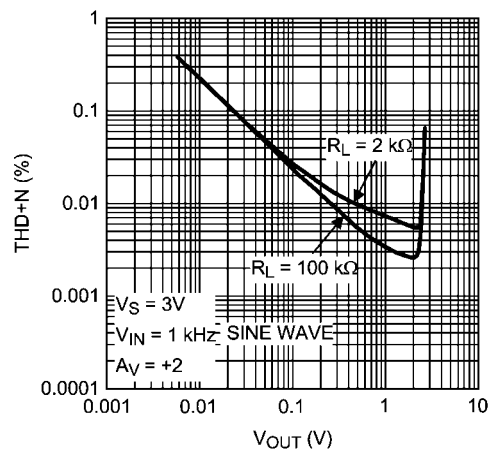

20123809

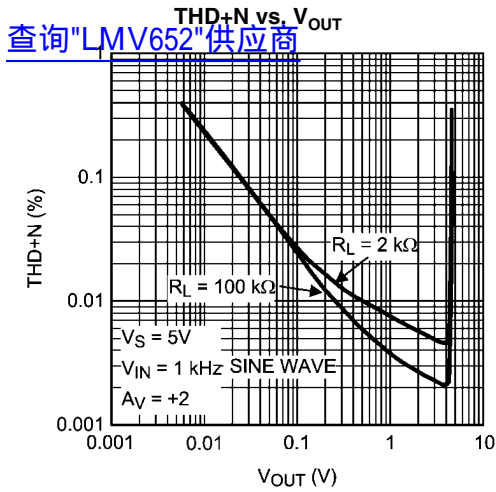

20123810

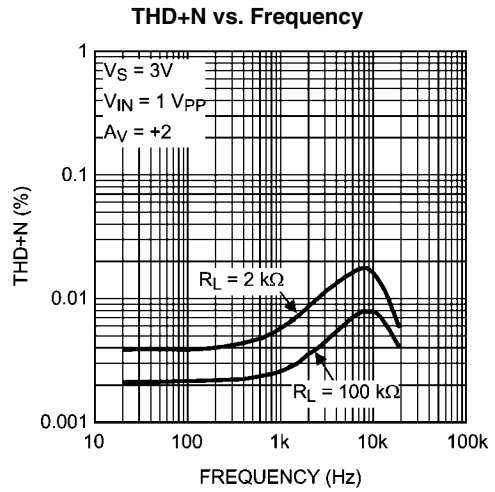

20123807

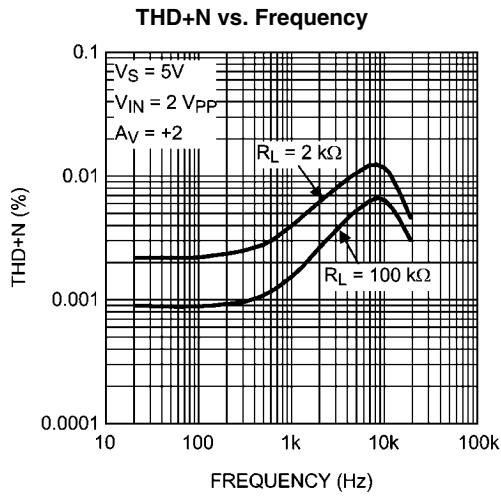

20123808

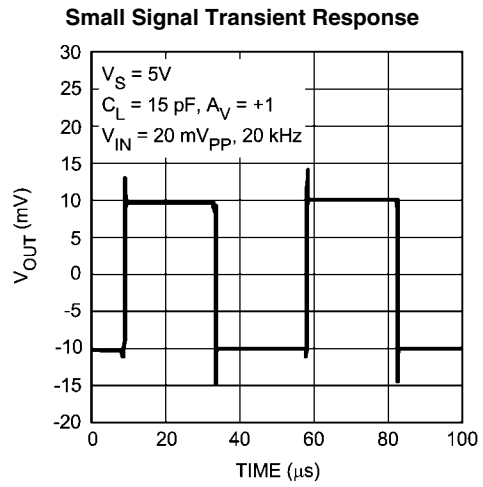

20123818

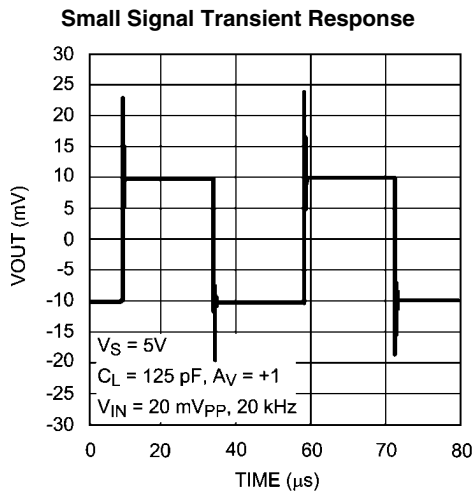

20123817

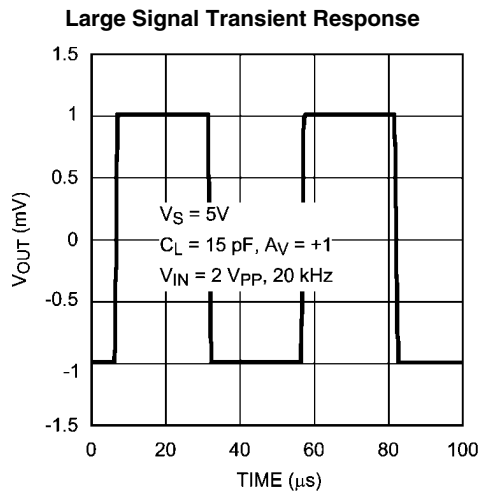

20123819

查询"LMV652"供应商

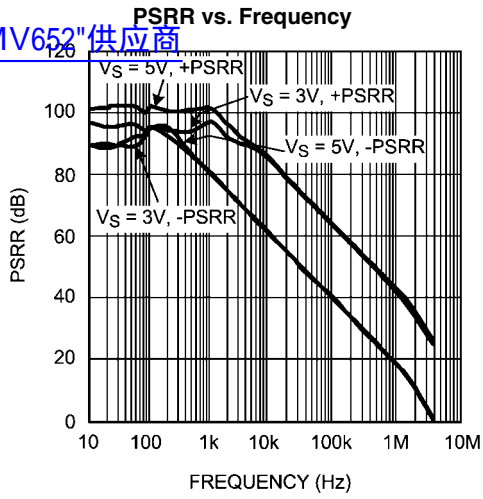

20123835

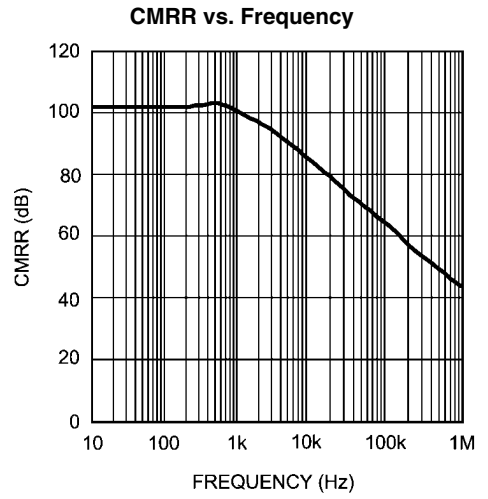

20123836

Closed Loop Output Impedance vs. Frequency

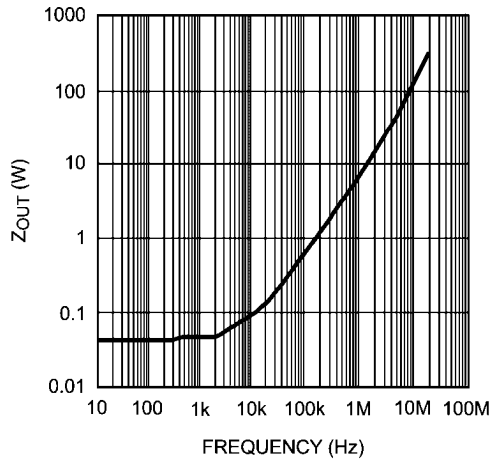

20123837

Application Information

查询"LMV652"供应商

ADVANTAGES OF THE LMV651/LMV652/LMV654

Low Voltage and Low Power Operation

The LMV651/LMV652/LMV654 have performance guaranteed at supply voltages of 3V and 5V. These parts are guaranteed to be operational at all supply voltages between 2.7V and 5.5V. The LMV651 draws a low supply current of 116 μ A, the LMV652 draws 118 μ A/channel and the LMV654 draws 122 μ A/channel. This family of op amps provides the low voltage and low power amplification which is essential for portable applications.

Wide Bandwidth

Despite drawing the very low supply current of 116 μ A, the LMV651/LMV652/LMV654 manage to provide a wide unity gain bandwidth of 12 MHz. This is easily one of the best bandwidth to power ratios ever achieved, and allows these op amps to provide wideband amplification while using the minimum amount of power. This makes this family of parts ideal for low power signal processing applications such as portable media players and other accessories.

Low Input Referred Noise

The LMV651/LMV652/LMV654 provide a flatband input referred voltage noise density of 17 nV/ $\sqrt{\text{Hz}}$, which is significantly better than the noise performance expected from a low power op amp. These op amps also feature exceptionally low 1/f noise, with a very low 1/f noise corner frequency of 4 Hz. This makes these parts ideal for low power applications which require decent noise performance, such as PDAs and portable sensors.

Ground Sensing and Rail-to-Rail Output

The LMV651/LMV652/LMV654 each have a rail-to-rail output stage, which provides the maximum possible output dynamic range. This is especially important for applications requiring a large output swing. The input common mode range of this family of devices includes the negative supply rail which allows direct sensing at ground in a single supply operation.

Small Size

The small footprint of the packages for the LMV651/LMV652/LMV654 saves space on printed circuit boards, and enables the design of smaller and more compact electronic products. Long traces between the signal source and the op amp make the signal path susceptible to noise. By using a physically smaller package, these op amps can be placed closer to the signal source, reducing noise pickup and enhancing signal integrity.

STABILITY OF OP AMP CIRCUITS

Stability and Capacitive Loading

If the phase margin of the LMV651/LMV652/LMV654 is plotted with respect to the capacitive load (C_L) at its output, it is seen that the phase margin reduces significantly if C_L is increased beyond 100 pF. This is because the op amp is designed to provide the maximum bandwidth possible for a low supply current. Stabilizing it for higher capacitive loads would have required either a drastic increase in supply current, or a large internal compensation capacitance, which would have reduced the bandwidth of the op amp. Hence, if these devices are to be used for driving higher capacitive loads, they would have to be externally compensated.

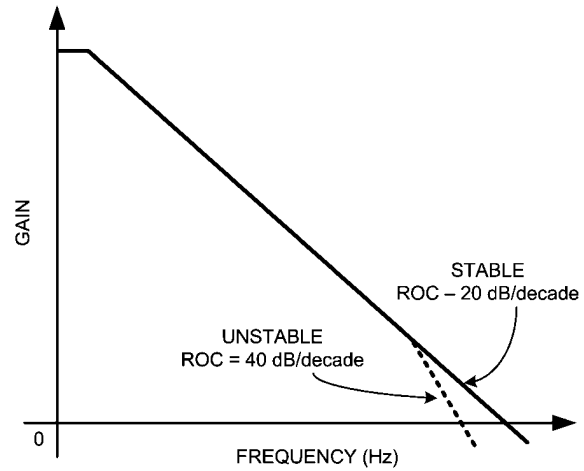

FIGURE 1. Gain vs. Frequency for an Op Amp

An op amp, ideally, has a dominant pole close to DC, which causes its gain to decay at the rate of 20 dB/decade with respect to frequency. If this rate of decay, also known as the rate of closure (ROC), remains the same until the op amp's unity gain bandwidth, the op amp is stable. If, however, a large capacitance is added to the output of the op amp, it combines with the output impedance of the op amp to create another pole in its frequency response before its unity gain frequency (Figure 1). This increases the ROC to 40 dB/decade and causes instability.

In such a case a number of techniques can be used to restore stability to the circuit. The idea behind all these schemes is to modify the frequency response such that it can be restored to an ROC of 20 dB/decade, which ensures stability.

In The Loop Compensation

Figure 2 illustrates a compensation technique, known as 'in the loop' compensation, that employs an RC feedback circuit within the feedback loop to stabilize a non-inverting amplifier configuration. A small series resistance, R_S , is used to isolate the amplifier output from the load capacitance, C_L , and a small capacitance, C_F , is inserted across the feedback resistor to bypass C_L at higher frequencies.

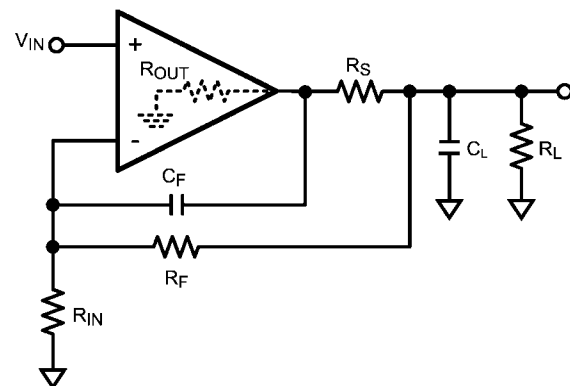

FIGURE 2. In the Loop Compensation

The values for R_S and C_F are decided by ensuring that the zero attributed to C_F lies at the same frequency as the pole attributed to C_L . This ensures that the effect of the second pole on the transfer function is compensated for by the presence of the zero, and that the ROC is maintained at 20 dB/decade. For the circuit shown in *Figure 2* the values of R_S and C_F are given by *Equation 1*. Values of R_S and C_F required for maintaining stability for different values of C_L , as well as the phase margins obtained, are shown in *Table 1*. R_F and R_{IN} are taken to be 10 k Ω , R_L is 2 k Ω , while R_{OUT} is taken as 340 Ω .

$$R_S = \frac{R_{OUT}R_{IN}}{R_F}$$

$$C_F = \left(\frac{R_F + 2R_{IN}}{R_F^2} \right) C_L R_{OUT} \quad (1)$$

TABLE 1.

C_L (pF)	R_S (Ω)	C_F (pF)	Phase Margin ($^\circ$)
150	340	15	39.4
200	340	20	34.6
250	340	25	31.1

Although this methodology provides circuit stability for any load capacitance, it does so at the price of bandwidth. The closed loop bandwidth of the circuit is now limited by R_F and C_F .

Compensation By External Resistor

In some applications it is essential to drive a capacitive load without sacrificing bandwidth. In such a case, in the loop compensation is not viable. A simpler scheme for compensation is shown in *Figure 3*. A resistor, R_{ISO} , is placed in series between the load capacitance and the output. This introduces a zero in the circuit transfer function, which counteracts the effect of the pole formed by the load capacitance, and ensures stability. The value of R_{ISO} to be used should be decided depending on the size of C_L and the level of performance desired. Values ranging from 5 Ω to 50 Ω are usually sufficient to ensure stability. A larger value of R_{ISO} will result in a system with lesser ringing and overshoot, but will also limit the output swing and the short circuit current of the circuit.

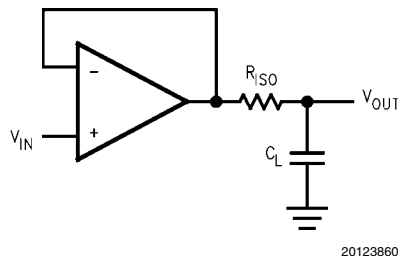

FIGURE 3. Compensation by Isolation Resistor

Typical Applications

HIGH GAIN LOW POWER AMPLIFIERS

With a low supply current, low power operation, and low harmonic distortion, the LMV651/LMV652/LMV654 are ideal for wide-bandwidth, high gain amplification. The wide unity gain bandwidth allows these parts to provide large gain over a wide frequency range, while driving loads as low as 2 k Ω with less

than 0.003% distortion. Two amplifier circuits are shown in *Figure 4* and *Figure 5*. *Figure 4* is an inverting amplifier, with a 100 k Ω feedback resistor, R_2 , and a 1 k Ω input resistor, R_1 , and provides a gain of -100 . With the LMV651/LMV652/LMV654 these circuits can provide gain of -100 with a -3 dB bandwidth of 120 kHz, for a quiescent current as low as 116 μ A. Similarly, the circuit in *Figure 5*, a non-inverting amplifier with a gain of 1001, can provide that gain with a -3 dB bandwidth of 12 kHz, for a similar low quiescent power dissipation. Coupling capacitors C_{C1} and C_{C2} can be added to isolate the circuit from DC voltages, while R_{B1} and R_{B2} provide DC biasing. A feedback capacitor C_F can also be added to improve compensation.

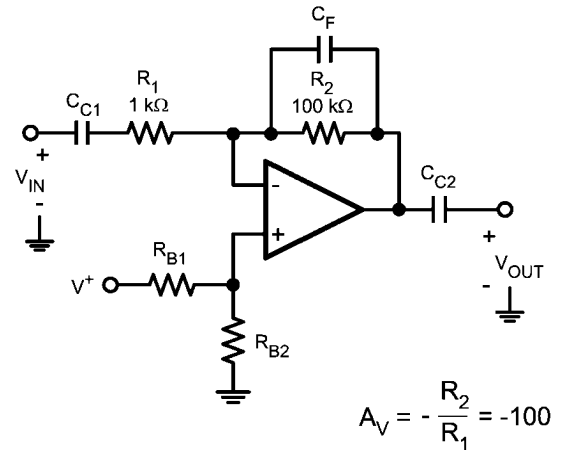

20123861

FIGURE 4. High Gain Inverting Amplifier

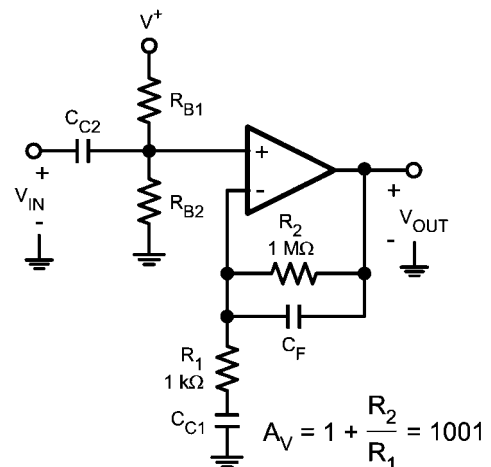

20123862

FIGURE 5. High Gain Non-Inverting Amplifier

ACTIVE FILTERS

With a wide unity gain bandwidth of 12 MHz, low input referred noise density and a low power supply current, the LMV651/LMV652/LMV654 are well suited for low-power filtering applications. Active filter topologies, like the Sallen-Key low pass filter shown in *Figure 6*, are very versatile, and can be used to design a wide variety of filters (Chebyshev, Butterworth or Bessel). The Sallen-Key topology, in particular, can be used to attain a range of Q, by using positive feedback to reject the undesired frequency range.

In the circuit shown in *Figure 6*, the two capacitors appear as open circuits at lower frequencies and the signal is simply buffered to the output. At high frequencies the capacitors appear as short circuits and the signal is shunted to ground by one of the capacitors before it can be amplified. Near the cut-off frequency, where the impedance of the capacitances is on the same order as R_g and R_f , positive feedback through the other capacitor allows the circuit to attain the desired Q. The ratio of the two resistors, m^2 , provides a knob to control the value of Q obtained.

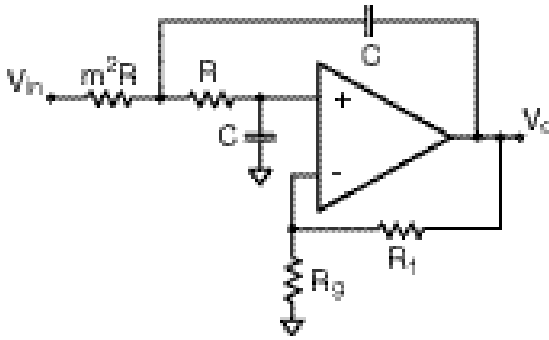

20123820

FIGURE 6. Sallen-Key Low Pass Filter

Physical Dimensions inches (millimeters) unless otherwise noted
[查询"LMV652"供应商](#)

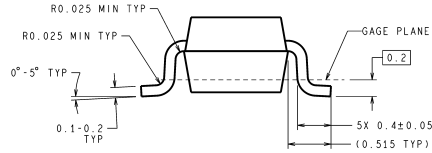
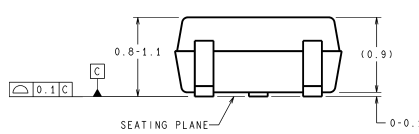
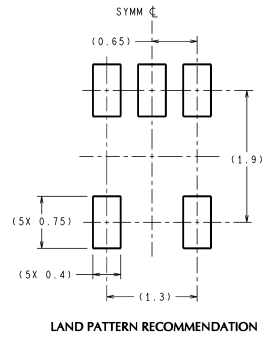
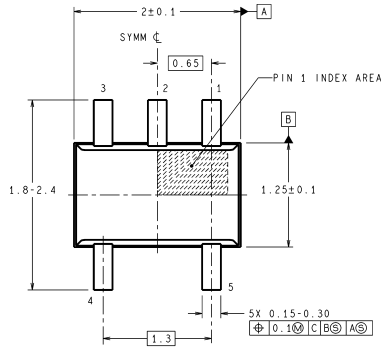

DIMENSIONS ARE IN MILLIMETERS
 DIMENSIONS IN () FOR REFERENCE ONLY

MAA05A (Rev D)

5-Pin SC70
NS Package Number MAA05A

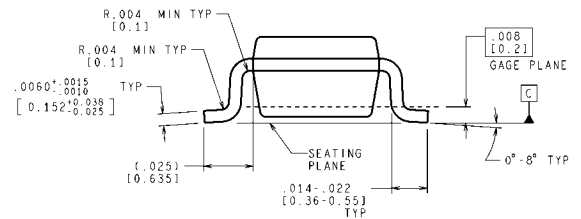
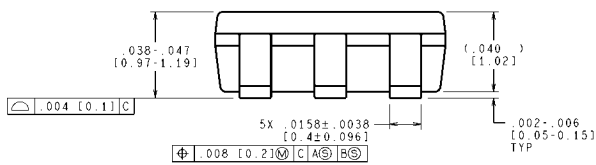
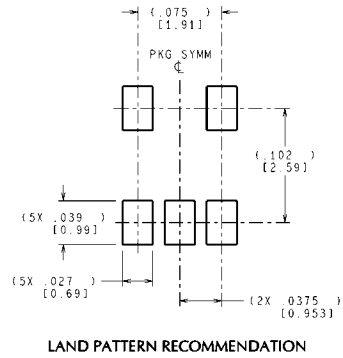
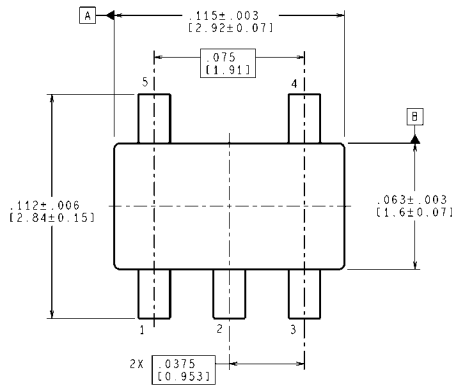

CONTROLLING DIMENSION IS INCH
 VALUES IN [] ARE MILLIMETERS
 DIMENSIONS IN () FOR REFERENCE ONLY

MF05A (Rev D)

5-Pin SOT-23
NS Package Number MF05A

查询"LMV652"供应商

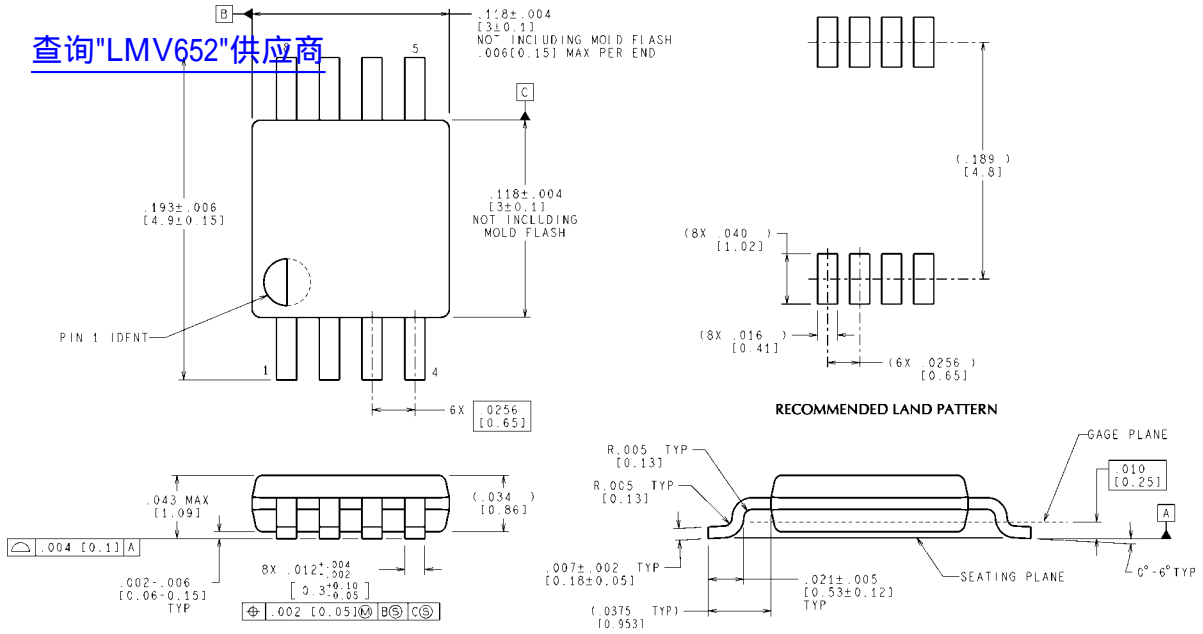

MUA08A (Rev F)

8-Pin MSOP
NS Package Number MUA08A

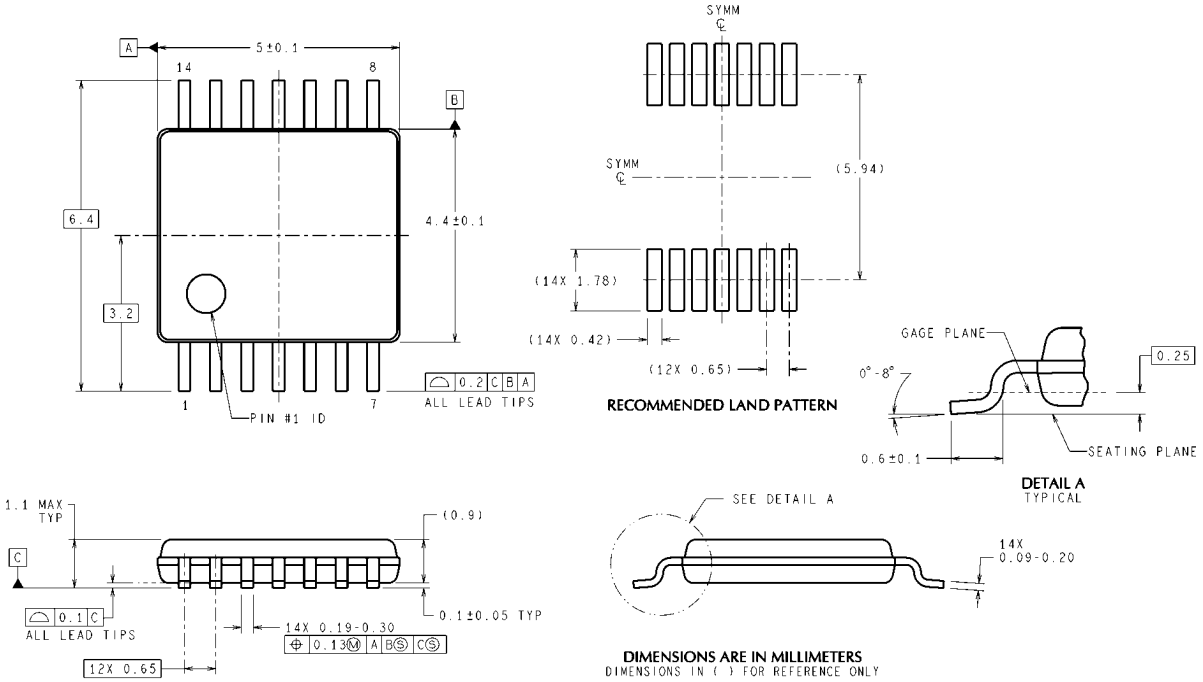

MTC14 (Rev D)

14-Pin TSSOP
NS Package Number MTC14

Notes

For more National Semiconductor product information and proven design tools, visit the following Web sites at:

Products		Design Support	
Amplifiers	www.national.com/amplifiers	WEBENCH	www.national.com/webench
Audio	www.national.com/audio	Analog University	www.national.com/AU
Clock Conditioners	www.national.com/timing	App Notes	www.national.com/appnotes
Data Converters	www.national.com/adc	Distributors	www.national.com/contacts
Displays	www.national.com/displays	Green Compliance	www.national.com/quality/green
Ethernet	www.national.com/ethernet	Packaging	www.national.com/packaging
Interface	www.national.com/interface	Quality and Reliability	www.national.com/quality
LVDS	www.national.com/lvds	Reference Designs	www.national.com/refdesigns
Power Management	www.national.com/power	Feedback	www.national.com/feedback
Switching Regulators	www.national.com/switchers		
LDOs	www.national.com/ldo		
LED Lighting	www.national.com/led		
PowerWise	www.national.com/powerwise		
Serial Digital Interface (SDI)	www.national.com/sdi		
Temperature Sensors	www.national.com/tempsensors		
Wireless (PLL/VCO)	www.national.com/wireless		

THE CONTENTS OF THIS DOCUMENT ARE PROVIDED IN CONNECTION WITH NATIONAL SEMICONDUCTOR CORPORATION ("NATIONAL") PRODUCTS. NATIONAL MAKES NO REPRESENTATIONS OR WARRANTIES WITH RESPECT TO THE ACCURACY OR COMPLETENESS OF THE CONTENTS OF THIS PUBLICATION AND RESERVES THE RIGHT TO MAKE CHANGES TO SPECIFICATIONS AND PRODUCT DESCRIPTIONS AT ANY TIME WITHOUT NOTICE. NO LICENSE, WHETHER EXPRESS, IMPLIED, ARISING BY ESTOPPEL OR OTHERWISE, TO ANY INTELLECTUAL PROPERTY RIGHTS IS GRANTED BY THIS DOCUMENT.

TESTING AND OTHER QUALITY CONTROLS ARE USED TO THE EXTENT NATIONAL DEEMS NECESSARY TO SUPPORT NATIONAL'S PRODUCT WARRANTY. EXCEPT WHERE MANDATED BY GOVERNMENT REQUIREMENTS, TESTING OF ALL PARAMETERS OF EACH PRODUCT IS NOT NECESSARILY PERFORMED. NATIONAL ASSUMES NO LIABILITY FOR APPLICATIONS ASSISTANCE OR BUYER PRODUCT DESIGN. BUYERS ARE RESPONSIBLE FOR THEIR PRODUCTS AND APPLICATIONS USING NATIONAL COMPONENTS. PRIOR TO USING OR DISTRIBUTING ANY PRODUCTS THAT INCLUDE NATIONAL COMPONENTS, BUYERS SHOULD PROVIDE ADEQUATE DESIGN, TESTING AND OPERATING SAFEGUARDS.

EXCEPT AS PROVIDED IN NATIONAL'S TERMS AND CONDITIONS OF SALE FOR SUCH PRODUCTS, NATIONAL ASSUMES NO LIABILITY WHATSOEVER, AND NATIONAL DISCLAIMS ANY EXPRESS OR IMPLIED WARRANTY RELATING TO THE SALE AND/OR USE OF NATIONAL PRODUCTS INCLUDING LIABILITY OR WARRANTIES RELATING TO FITNESS FOR A PARTICULAR PURPOSE, MERCHANTABILITY, OR INFRINGEMENT OF ANY PATENT, COPYRIGHT OR OTHER INTELLECTUAL PROPERTY RIGHT.

LIFE SUPPORT POLICY

NATIONAL'S PRODUCTS ARE NOT AUTHORIZED FOR USE AS CRITICAL COMPONENTS IN LIFE SUPPORT DEVICES OR SYSTEMS WITHOUT THE EXPRESS PRIOR WRITTEN APPROVAL OF THE CHIEF EXECUTIVE OFFICER AND GENERAL COUNSEL OF NATIONAL SEMICONDUCTOR CORPORATION. As used herein:

Life support devices or systems are devices which (a) are intended for surgical implant into the body, or (b) support or sustain life and whose failure to perform when properly used in accordance with instructions for use provided in the labeling can be reasonably expected to result in a significant injury to the user. A critical component is any component in a life support device or system whose failure to perform can be reasonably expected to cause the failure of the life support device or system or to affect its safety or effectiveness.

National Semiconductor and the National Semiconductor logo are registered trademarks of National Semiconductor Corporation. All other brand or product names may be trademarks or registered trademarks of their respective holders.

Copyright© 2008 National Semiconductor Corporation

For the most current product information visit us at www.national.com



**National Semiconductor
Americas Technical
Support Center**
Email: support@nsc.com
Tel: 1-800-272-9959

**National Semiconductor Europe
Technical Support Center**
Email: europe.support@nsc.com
German Tel: +49 (0) 180 5010 771
English Tel: +44 (0) 870 850 4288

**National Semiconductor Asia
Pacific Technical Support Center**
Email: ap.support@nsc.com

**National Semiconductor Japan
Technical Support Center**
Email: jpn.feedback@nsc.com