

power light source

Luxeon® Ring

Technical Data DS22

Luxeon® is a revolutionary, energy efficient and ultra compact new light source, combining the lifetime and reliability advantages of Light Emitting Diodes with the brightness of conventional lighting.

Luxeon features one or more power light sources mounted onto an aluminum-core printed circuit board, allowing for ease of assembly, optimum cooling and accurate light center positioning.

For high volume applications, custom Luxeon power light source designs are available upon request, to meet your specific needs.

Luxeon Power Light Sources give you total design freedom and unmatched brightness, creating a new world of light.



Luxeon Ring is available in white, green, cyan, blue, red, and amber.

Features

- Highest Flux per LED in the world
- Very long operating life (up to 100k hours)
- Available in white, green, cyan, blue, red and amber
- Highly efficient collimating optics provide tight beams
- More energy efficient than incandescent and most halogen lamps
- Low voltage DC operated
- Cool beam, safe to the touch
- Instant light (less than 100 ns)
- Fully dimmable
- No UV
- Superior ESD protection

Typical Applications

- Decorative lighting
- Architectural detail lighting
- Uplighters/Downlighters/Orientation lighting
- Entertainment lighting
- Bollards

Mechanical Dimensions

Ring with 6 LEDs

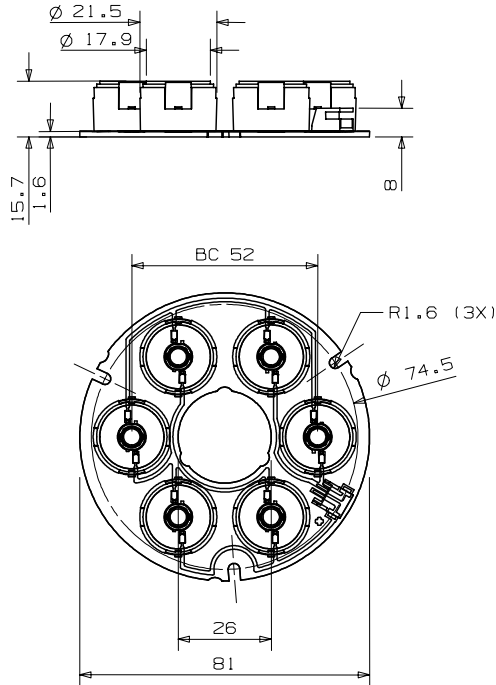

Notes:

1. Connector on board AMP type, code 2-179123-2; Mating connector – AMP receptacle housing assembly, code 173977-2
2. Slots in aluminum-core PCB for M3 or #4 mounting screw.
3. Drawing not to scale.
4. All dimensions are in millimeters.

Ring with 12 LEDs

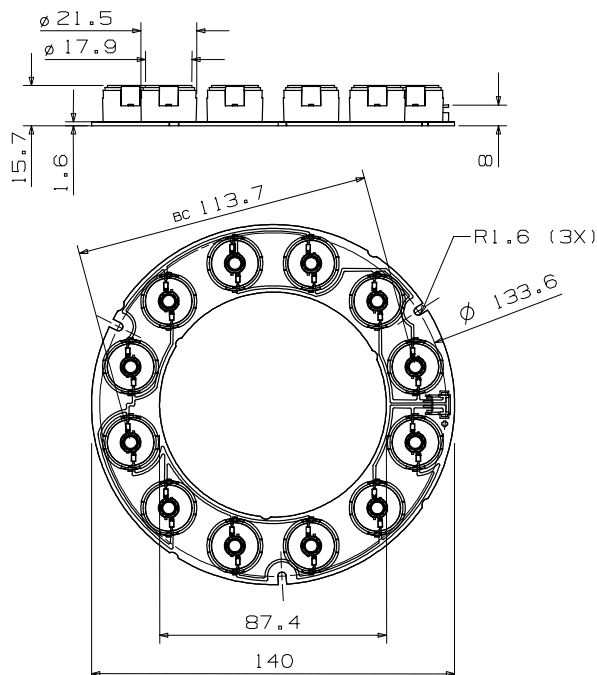

Notes:

1. Connector on board AMP type, code 2-179123-2; Mating connector – AMP receptacle housing assembly, code 173977-2
2. Slots in aluminum-core PCB for M3 or #4 mounting screw.
3. Drawing not to scale.
4. All dimensions are in millimeters.

Circuit Diagram

Ring with 12 LEDs

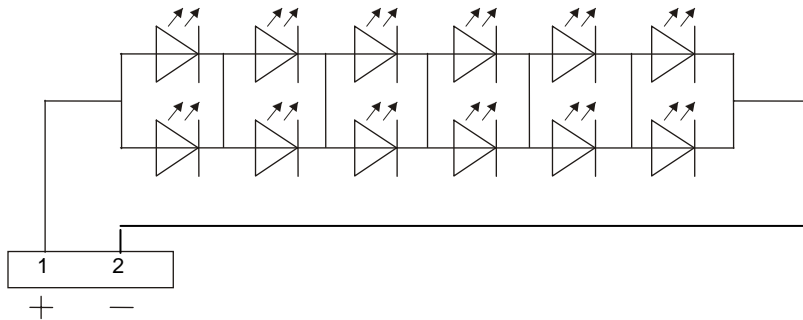

Ring with 6 LEDs

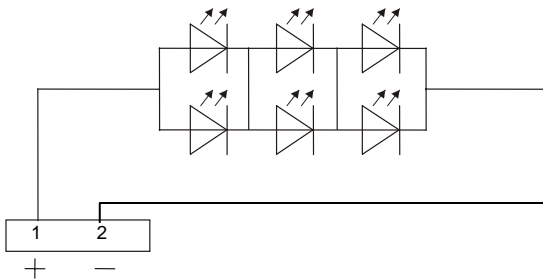

Flux Characteristics at 700mA, Junction Temperature, $T_J = 25^\circ\text{C}$

| Configuration | Color | Part Number | Minimum Luminous Flux (lm) $\Phi_V^{[1,2]}$ | Typical Luminous Flux (lm) $\Phi_V^{[2]}$ |
|---------------|---------------------|-------------|---|---|
| Ring 12-up | White | LXHL-NWE6 | 140 | 250 |
| | Green | LXHL-NM96 | 140 | 300 |
| | Cyan | LXHL-NE96 | 140 | 300 |
| | Blue ^[3] | LXHL-NB96 | 40 | 100 |
| | Red | LXHL-ND92 | 310 | 450 |
| | Amber | LXHL-NL92 | 240 | 425 |
| Ring 6-up | White | LXHL-NWE7 | 70 | 125 |
| | Green | LXHL-NM97 | 70 | 150 |
| | Cyan | LXHL-NE97 | 70 | 150 |
| | Blue ^[3] | LXHL-NB97 | 20 | 50 |
| | Red | LXHL-ND93 | 155 | 225 |
| | Amber | LXHL-NL93 | 120 | 215 |

Notes:

1. Minimum luminous flux performance guaranteed within published operating conditions. Lumileds maintains a tolerance of +/-10% for luminous flux measurements.
2. Flux values for Luxeon Ring with optics. Luxeon types with even higher luminous flux levels will become available in the future. Please consult your Lumileds Authorized Distributor or Lumileds sales representative for more information.
3. Minimum flux value for 470 nm devices. Due to the CIE eye response curve in the short blue wavelength range, the minimum luminous flux will vary over the Lumileds' blue color range. Luminous flux will range from minimums of 30 lm for 12-Up and 15 lm for 6-Up Rings at 460nm to typicals of 150 lm for 12-Up and 75 lm for 6-Up Rings at 480nm due to this effect. Although the luminous power efficiency is lower in the short blue wavelength range, radiometric power efficiency increases as wavelength decreases. For more information, consult the Luxeon Design Guide, available upon request.

查询"LXHL-ND93"供应商

Optical Characteristics at 700mA, Junction Temperature, T_J = 25°C

| Color | Dominant Wavelength ^[1] λD or Color Temperature ^[2] CCT | | | Spectral Half- width ^[3] (nm) Δλ _{1/2} | temperature coefficient of dominant wavelength (nm/°C) Δλ _D / ΔT _J | Viewing Angle per LED ^[4] (Degrees) 2θ 1/2 | Typical Candela on Axis per LED ^[8] (Cd) |
|-------|---|--------|----------|--|---|---|--|
| | Min. | Typ. | Max. | | | | |
| White | 4500 K | 5500 K | 10,000 K | --- | --- | 10 | 250 |
| Green | 520 nm | 530 nm | 550 nm | 35 | 0.04 | 10 | 600 |
| Cyan | 490 nm | 505 nm | 520 nm | 30 | 0.04 | 10 | 600 |
| Blue | 460 nm | 470 nm | 490 nm | 25 | 0.04 | 10 | 200 ^[5] |
| Red | 620.5 nm | 627 nm | 645 nm | 20 | 0.05 | 10 | 660 |
| Amber | 584.5 nm | 590 nm | 597 nm | 14 | 0.09 | 10 | 540 |

Electrical Characteristics at 700mA, Junction Temperature, T_J = 25°C

Ring 12-Up

| Color | Part Number | Forward Voltage ^[1] (V) V _F | | | Dynamic resistance ^[2] (Ω) R _D | Temp coefficient of forward voltage ^[3] (mV/°C) ΔV _F / ΔT _J | Thermal resistance, junction to board ^[4] (°C/W) Rθ _{J-B} |
|-------|-------------|---|------|------|--|---|---|
| | | Min. | Typ. | Max. | | | |
| White | LXHL-NWE6 | 16 | 21 | 24 | 3 | -12 | 1.7 |
| Green | LXHL-NM96 | 16 | 21 | 24 | 3 | -12 | 1.7 |
| Cyan | LXHL-NE96 | 16 | 21 | 24 | 3 | -12 | 1.7 |
| Blue | LXHL-NB96 | 16 | 21 | 24 | 3 | -12 | 1.7 |
| Red | LXHL-ND92 | 14 | 18 | 21 | 7.2 | -12 | 1.9 |
| Amber | LXHL-NL92 | 14 | 18 | 21 | 7.2 | -12 | 1.9 |

Ring 6-Up

| Color | Part Number | Forward Voltage (V) V _F | | | Dynamic resistance ^[1] (Ω) R _D | Temp coefficient of forward voltage ^[2] (mV/°C) ΔV _F / ΔT _J | Thermal resistance, junction to board ^[3] (°C/W) Rθ _{J-B} |
|-------|-------------|------------------------------------|------|------|--|---|---|
| | | Min. | Typ. | Max. | | | |
| White | LXHL-NWE7 | 8 | 10 | 12 | 1.5 | -6 | 3.3 |
| Green | LXHL-NM97 | 8 | 10 | 12 | 1.5 | -6 | 3.3 |
| Cyan | LXHL-NE97 | 8 | 10 | 12 | 1.5 | -6 | 3.3 |
| Blue | LXHL-NB97 | 8 | 10 | 12 | 1.5 | -6 | 3.3 |
| Red | LXHL-ND93 | 7 | 9 | 11 | 3.6 | -6 | 3.8 |
| Amber | LXHL-NL93 | 7 | 9 | 11 | 3.6 | -6 | 3.8 |

Absolute Maximum Ratings

| Parameter | White/Green/Cyan/Blue | Red/Amber |
|--|-----------------------|------------|
| DC Forward Current (mA) ^[1] | 700 | 770 |
| Peak Pulsed Forward Current (mA) | 1000 | 1100 |
| Average Forward Current (mA) | 700 | 700 |
| ESD Sensitivity ^[2] | ± 16,000V HBM | |
| LED Junction Temperature (°C) | 135 | 120 |
| Aluminum-Core PCB Temperature (°C) | 105 | 105 |
| Storage & Operating Temperature (°C) | -40 to +75 | -40 to +75 |

Notes:

1. Dominant wavelength is derived from the CIE 1931 Chromaticity diagram and represents the perceived color.
2. CRI (Color Rendering Index) for White product is 70.
3. Spectral width at 1/2 of the peak intensity.
4. θ_{1/2} is the off axis angle from lamp centerline where the luminous intensity is 1/2 of the peak value.
5. Typical candela on axis per LED for 470 nm devices. Due to the CIE eye response curve in the short blue wavelength range, candela values will vary over the LumiLeds blue color range.
6. All red and amber products built with Aluminum Indium Gallium Phosphide (AlInGaP).
7. All white, green, cyan and blue products built with Indium Gallium Nitride (InGaN).
8. All power light sources represented here are IEC825 Class 2 for eye safety.

Notes:

1. Lumileds maintains a tolerance of +/-0.06 Volts per LED for voltage measurements.
2. Dynamic resistance is the inverse of the slope in linear forward voltage model for LEDs. See *Figures 3a and 3b*.
3. Measured between 25°C ≤ T_J ≤ 110°C at I_F = 700mA.
4. To determine the junction temperature, multiply by total array power. For best optical and lifetime performance, additional heat sinking is required.

Notes:

1. Proper current derating must be observed to maintain junction temperature below the maximum. For more information, consult Luxeon Design Guide, available upon request.
2. LEDs are not designed to be driven in reverse bias. Please consult Lumileds' Application Brief AB11 for further information.

Wavelength Characteristics

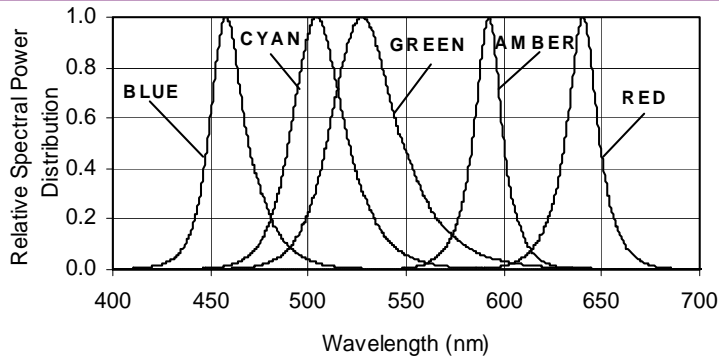

Figure 1a.
Relative Intensity vs. Wavelength.

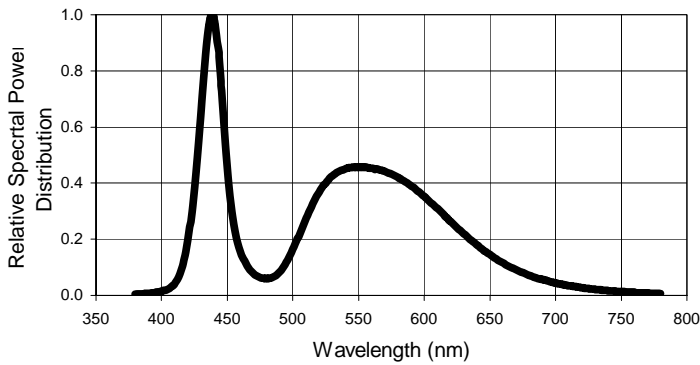

Figure 1b.
White Color Spectrum of Typical CCT Part, Integrated Measurement.

Light Output Characteristics

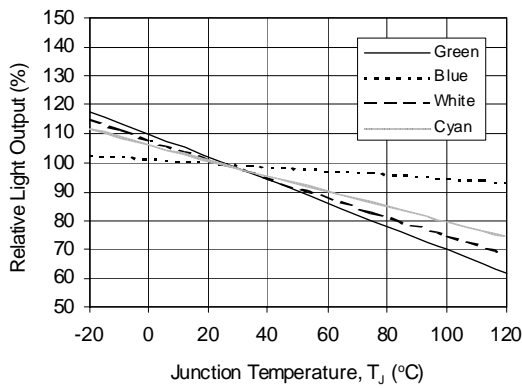

Figure 2a.
Relative Light Output vs. Junction Temperature for White, Green, Cyan and Blue.

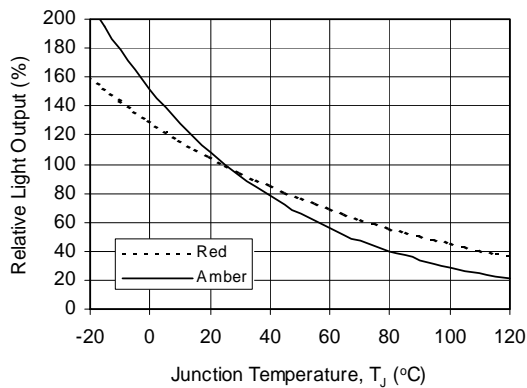

Figure 2b.
Relative Light Output vs. Junction Temperature for Red and Amber.

Forward Current Characteristics, $T_J = 25^\circ\text{C}$

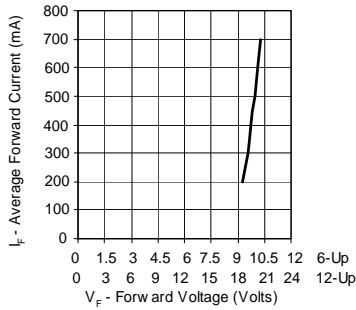

Figure 3a. Forward Current vs. Forward Voltage for White, Green, Cyan and Blue.

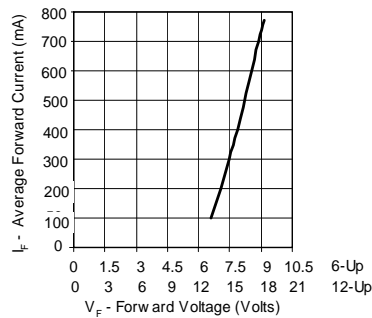

Figure 3b. Forward Current vs. Forward Voltage for Red and Amber.

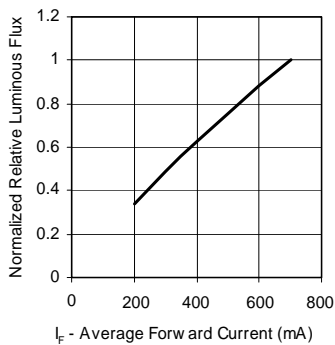

Figure 4a. Relative Luminous Flux vs. Forward Current for White, Green, Cyan and Blue at $T_J = 25^\circ\text{C}$ maintained.

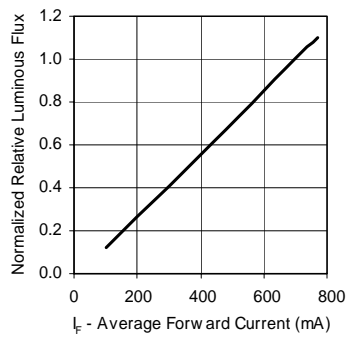

Figure 4b. Relative Luminous Flux vs. Forward Current for Red and Amber at $T_J = 25^\circ\text{C}$ maintained.

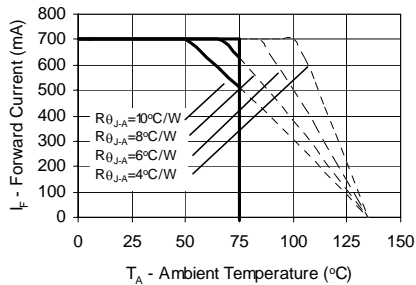

Figure 5a. Maximum Forward Current vs. Ambient Temperature. Derating based on $T_{JMAX} = 135^\circ\text{C}$ for White, Green, Cyan and Blue 6-Up Ring.

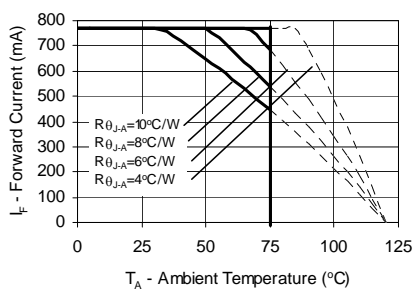
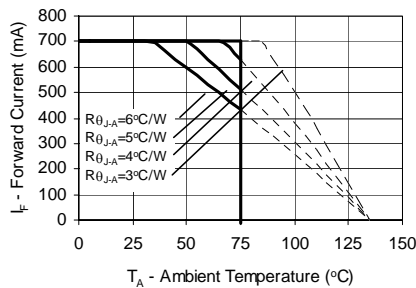
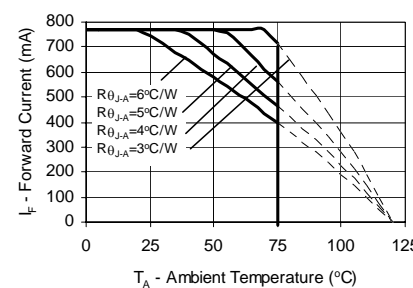

Figure 5b. Maximum Forward Current vs. Ambient Temperature. Derating based on $T_{JMAX} = 120^\circ\text{C}$ for Red and Amber 6-Up Ring.



Ambient Temperature. Derating based on $T_{JMAX} = 135^\circ\text{C}$ for White, Green, Cyan and Blue 12-Up Ring.



Ambient Temperature. Derating based on $T_{JMAX} = 120^\circ\text{C}$ for Red and Amber 12-Up Ring.

Note:

Driving these high power devices at currents less than the test conditions may produce unpredictable results and may be subject to variation in performance. Pulse width modulation is recommended for dimming effects.

Representative Spatial Radiation Pattern

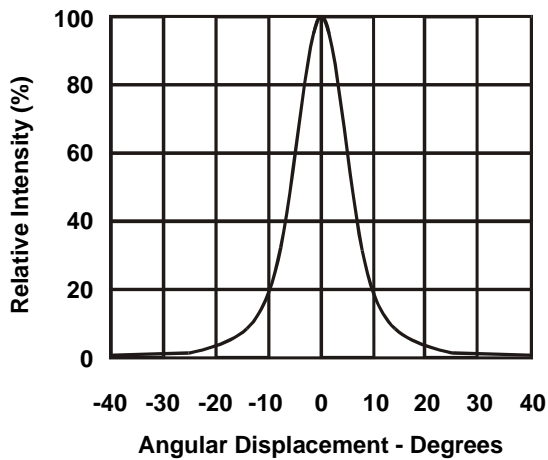

Figure 7.
Representative Spatial Radiation Pattern
for one Luxeon LED with optics, all
colors.

Note:

For more detailed technical information regarding Luxeon radiation patterns, please consult your Lumileds Authorized Distributor or Lumileds sales representative.

Average Lumen Maintenance Characteristics

Lifetime for solid-state lighting devices (LEDs) is typically defined in terms of lumen maintenance—the percentage of initial light output remaining after a specified period of time. Lumileds projects that Luxeon products will deliver on average 70% lumen maintenance at 50,000 hours of operation. This performance is based on independent test data, Lumileds historical data from tests run on similar material systems, and internal Luxeon reliability testing. This projection is based on constant current 350 mA operation per LED (700 mA for Ring) with junction temperature maintained at or below 90°C. Observation of design limits included in this data sheet is required in order to achieve this projected lumen maintenance.

About Luxeon



Luxeon is the new world of solid-state lighting (LED) technology. Luxeon Power Light Source Solutions offer huge advantages over conventional lighting and huge advantages over other LED solutions. Luxeon enables partners to create and market products that, until now, were impossible to create. This means the opportunity to create products with a clear competitive advantage in the market. Products that are smaller, lighter, sleeker, cooler, and brighter. Products that are more fun to use, more efficient, and more environmentally conscious than ever before possible!



Company Information

Luxeon is developed, manufactured and marketed by Lumileds Lighting, LLC. Lumileds is a world-class supplier of Light Emitting Diodes (LEDs) producing billions of LEDs annually. Lumileds is a fully integrated supplier, producing core LED material in all three base colors (Red, Green, Blue) and White. Lumileds has R&D development centers in San Jose, California and Best, The Netherlands. Production capabilities in San Jose, California and Malaysia.

Lumileds is pioneering the high-flux LED technology and bridging the gap between solid state LED technology and the lighting world. Lumileds is absolutely dedicated to bringing the best and brightest LED technology to enable new applications and markets in the Lighting world.



©2005 Lumileds Lighting. All rights reserved. Luxeon is a trademark of Lumileds Lighting, U.S., LLC. Product specifications are subject to change without notice.

Lumileds may make process or materials changes affecting the performance or other characteristics of Luxeon. These products supplied after such change will continue to meet published specifications, but may not be identical to products supplied as samples or under prior orders.

Lumileds

www.luxeon.com
www.lumileds.com

For technical assistance or the location of your nearest Lumileds sales office, call:

Worldwide:
+1 408-435-6111
US Toll free: 1-888-589-3662
Asia: 800-5864-5337
Europe: 00 800 443 88 873
Fax: +1 408-435-6855
Email us at info@lumileds.com

Lumileds Lighting, U.S., LLC
370 West Trimble Road
San Jose, CA 95131