

2SK3780-01

N-CHANNEL SILICON POWER MOSFET

FUJI POWER MOSFET Super FAP-G Series

Features

- High speed switching, Low on-resistance
- Low driving power, Avalanche-proof
- No secondary breakdown

Applications

- Switching regulators
- UPS (Uninterruptible Power Supply)
- DC-DC converters

Maximum ratings and characteristic

Absolute maximum ratings
(T_c=25°C unless otherwise specified)

Item	Symbol	Ratings	Unit	Remarks
Drain-source voltage	V _{DS}	200	V	
	V _{DSX}	200	V	V _{GS} =-30V
Continuous Drain Current	I _D	73	A	
Pulsed Drain Current	I _D (puls)	±292	A	
Gate-Source Voltage	V _{GS}	±30	V	
Maximum Avalanche current	I _{AR}	73	A	Note *1
Non-Repetitive Maximum Avalanche Energy	E _{AS}	1115.2	mJ	Note *2
Repetitive Maximum Avalanche Energy	E _{AR}	41	mJ	Note *3
Maximum Drain-Source dV/dt	dV _{DS} /dt	20	kV/μs	V _{DS} ≤200V
Peak Diode Recovery dV/dt	dV/dt	5	kV/μs	Note *4
Max. Power Dissipation	P _D	410	W	T _c =25°C
		2.50		T _a =25°C
Operating and Storage Temperature range	T _{ch}	+150	°C	
	T _{stg}	-55 to +150	°C	

Electrical characteristics (T_c=25°C unless otherwise specified)

Item	Symbol	Test Conditions	Min.	Typ.	Max.	Units
Drain-Source Breakdown Voltage	BV _{DSS}	I _D =250μA V _{GS} =0V	200			V
Gate Threshold Voltage	V _{GS(th)}	I _D =250μA V _{DS} =V _{GS}	3.0		5.0	V
Zero Gate Voltage Drain Current	I _{DSS}	V _{DS} =200V V _{GS} =0V			25	μA
		V _{DS} =160V V _{GS} =0V			250	
Gate-Source Leakage Current	I _{GSS}	V _{GS} =±30V V _{DS} =0V			100	nA
Drain-Source On-State Resistance	R _{DS(on)}	I _D =36.5A V _{GS} =10V		29	36	mΩ
Forward Transconductance	g _{fs}	I _D =36.5A V _{DS} =25V	12	24		S
Input Capacitance	C _{iss}	V _{DS} =75V		3800	5400	pF
Output Capacitance	C _{oss}	V _{GS} =0V		530	795	
Reverse Transfer Capacitance	C _{rss}	f=1MHz		35	52.5	
Turn-On Time t _{on}	t _{d(on)}	V _{CC} =48V I _D =36.5A		40	60	ns
	t _r	V _{GS} =10V		94	141	
Turn-Off Time t _{off}	t _{d(off)}	R _{GS} =10Ω		60	90	ns
	t _f			30	45	
Total Gate Charge	Q _G	V _{CC} =100V		80	120	nC
Gate-Source Charge	Q _{GS}	I _D =73A		30	45	
Gate-Drain Charge	Q _{GD}	V _{GS} =10V		25	38	
Diode forward on-voltage	V _{SD}	I _F =73A V _{GS} =0V T _{ch} =25°C		1.20	1.50	V
Reverse recovery time	t _{rr}	I _F =73A V _{GS} =0V		300		ns
Reverse recovery charge	Q _{rr}	-di/dt=100A/μs T _{ch} =25°C		3.0		μC

Thermal characteristics

Item	Symbol	Test Conditions	Min.	Typ.	Max.	Units
Thermal resistance	R _{th(ch-c)}	channel to case			0.305	°C/W
	R _{th(ch-a)}	channel to ambient			50.0	°C/W

Outline Drawings (mm) 200406

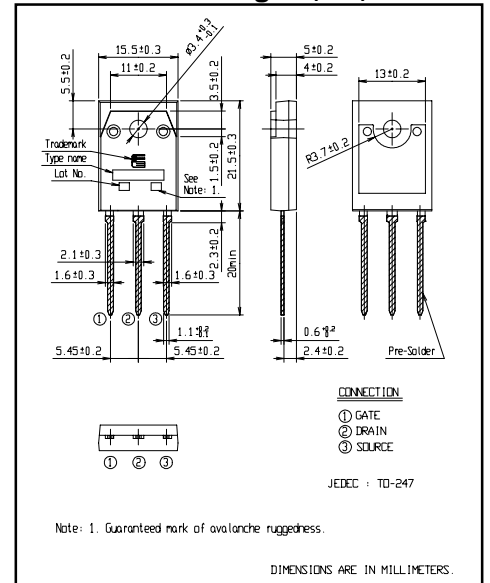

Equivalent circuit schematic

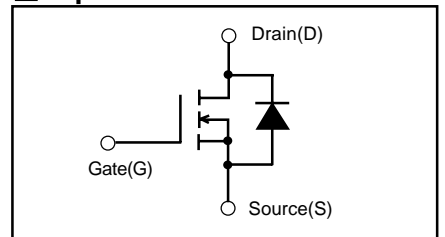

Note *1: T_{ch} ≤ 150°C, Repetitive and Non-repetitive

Note *2: Starting T_{ch}=25°C, I_{AS}=30A, L=1.98mH,

V_{CC}=48V, R_G=50Ω

EAS limited by maximum channel temperature and avalanche current.

See to the 'Avalanche Energy' graph

Note *3: Repetitive rating: Pulse width limited by maximum channel temperature.

See to the 'Transient Thermal impedance' graph

Note *4: I_r ≤ -I_D, -di/dt=50A/μs, V_{CC} ≤ BV_{DSS}, T_{ch} ≤ 150°C

[查询"2SK3780-01"供应商](#)

Characteristics

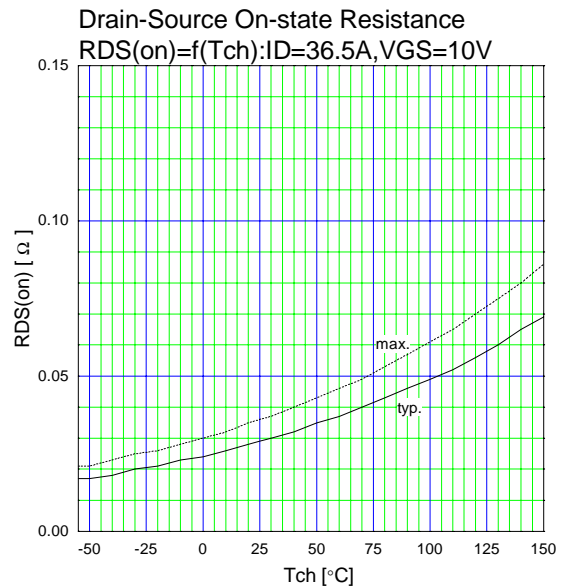
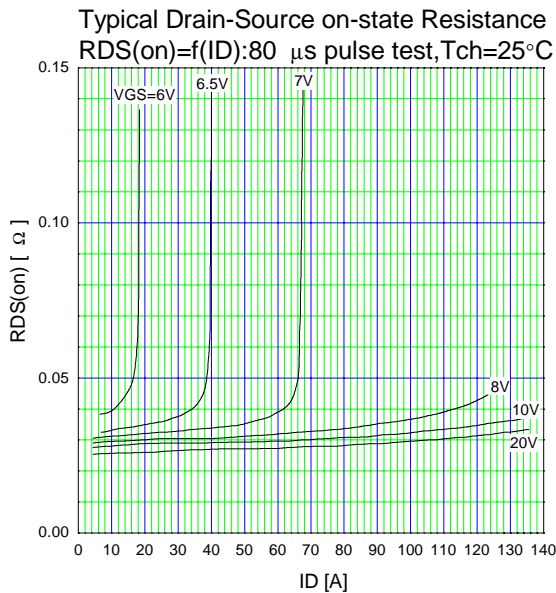
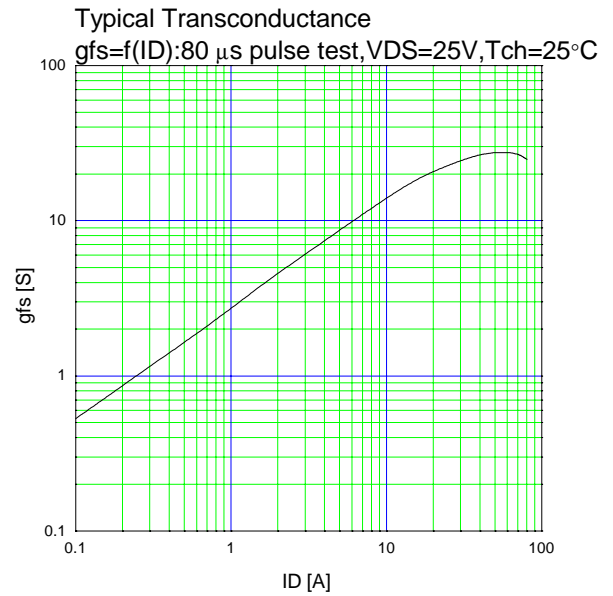
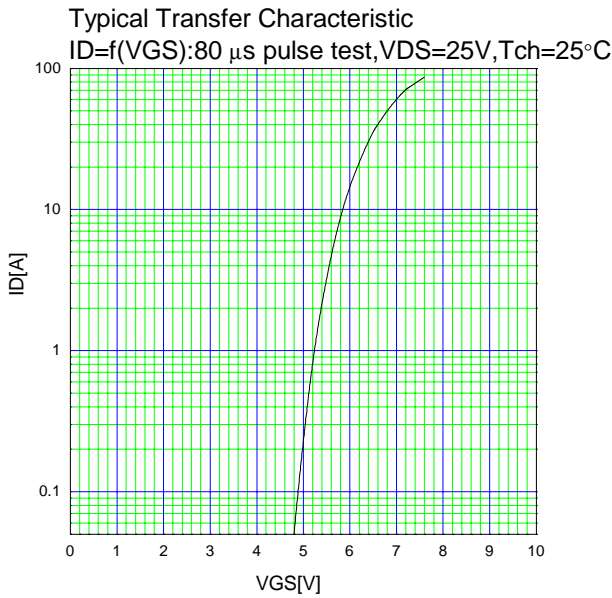
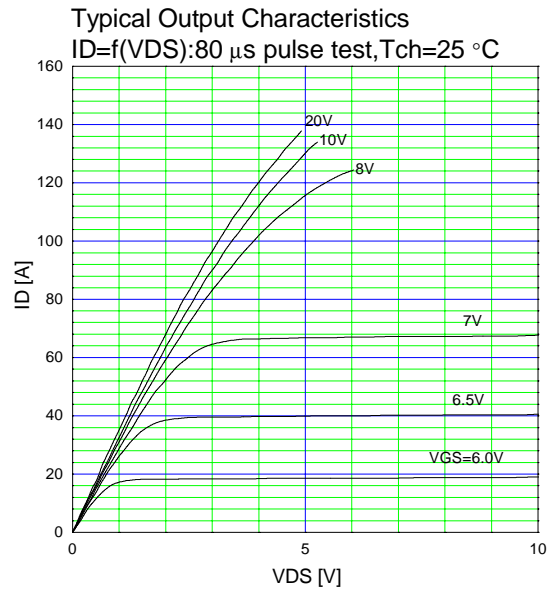
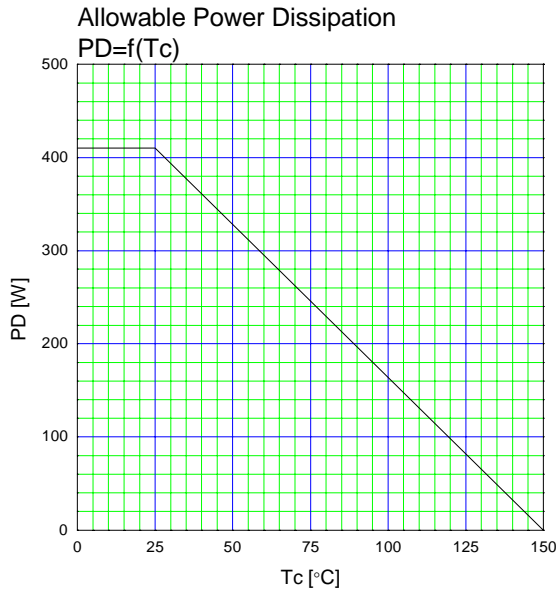

[查询"2SK3780-01"供应商](#)

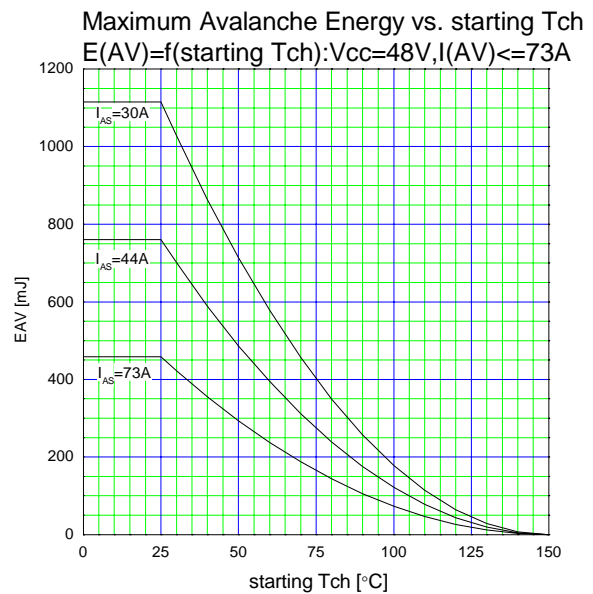
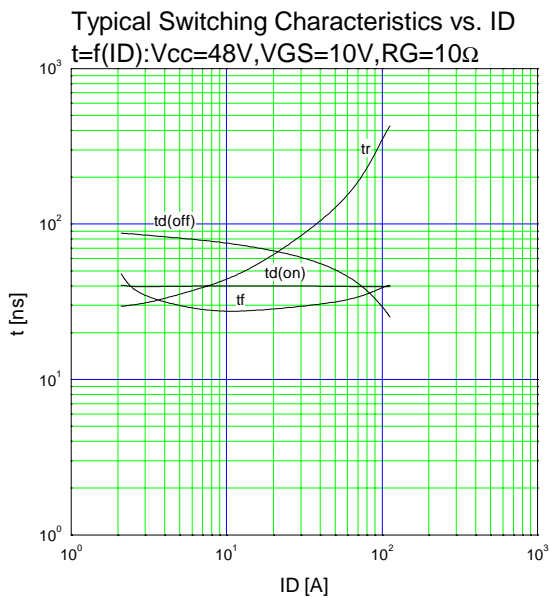
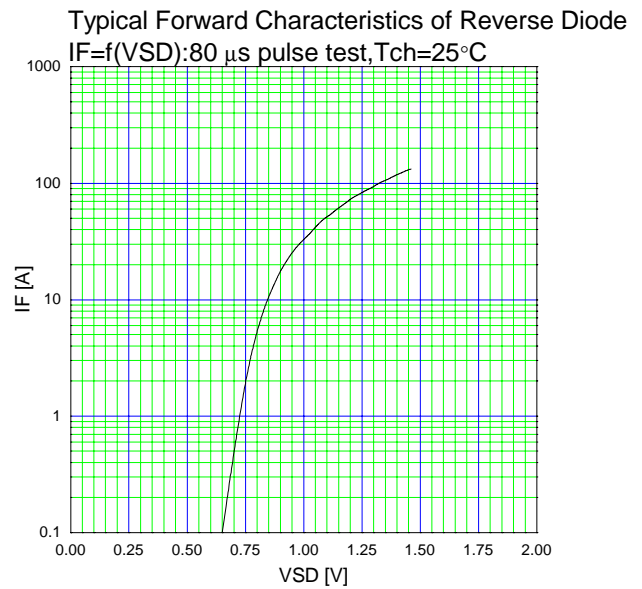
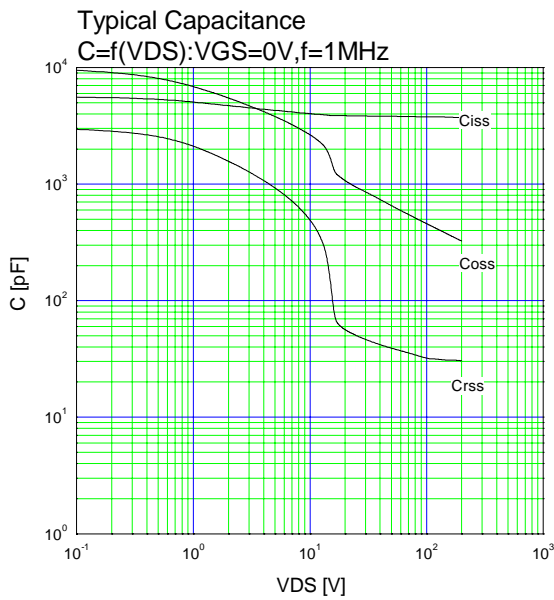
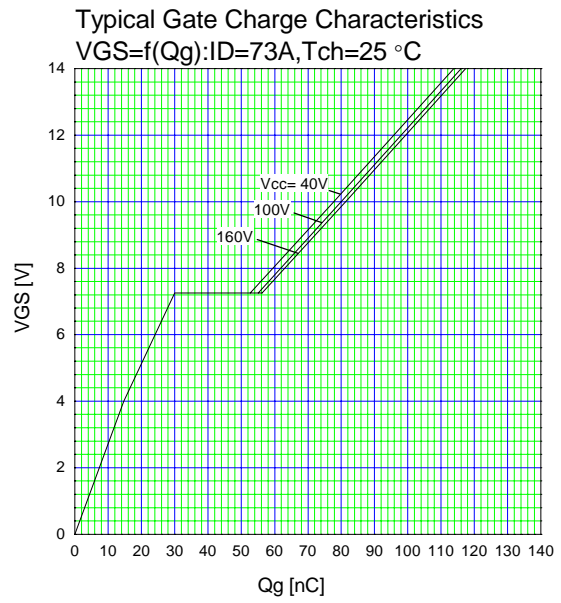
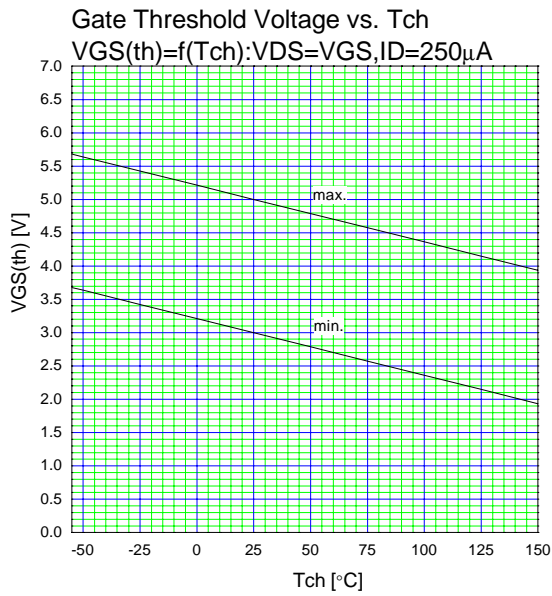

[查询"2SK3780-01"供应商](#)

