

## INTRODUCTION

### 查询"500797"供应商

The 500797 FPC series from Molex offers very high cable retention forces as a result of a unique alternating spring contact design. Alternating even and odd terminals provide opposing forces to create a high FPC retention force.

This miniature version also features an FPC hold feature that keeps the FPC in place after inserting. This feature also prevents the FPC from moving during actuation and enables higher retention forces after actuating.

#### Specifications:

- Current: 0.2A
- Voltage: 50V
- Circuit Size Range: 11-51
- Contact Resistance:
  - 80 milliohms max. (Odd Circuit)
  - 40 milliohms max. (Even Circuit)
- Insulation Resistance: 50 Megohms min.
- Dielectric Withstanding Voltage: AC250V
- Terminal Retention Force:
  - 0.5N {0.05kgf} min.
- Durability: 20 Cycles



## 0.30mm (.012") Pitch FPC Connector 1.05mm (.041") Height 500797

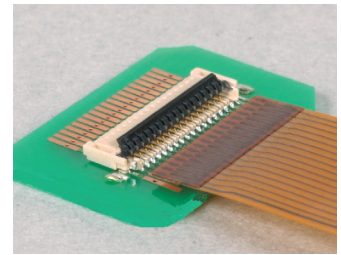

## FEATURES AND BENEFITS

### Superior terminal design allows for high retention force

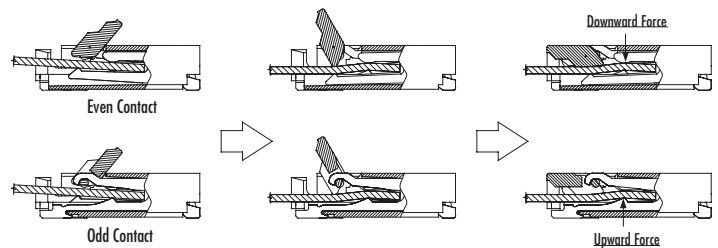
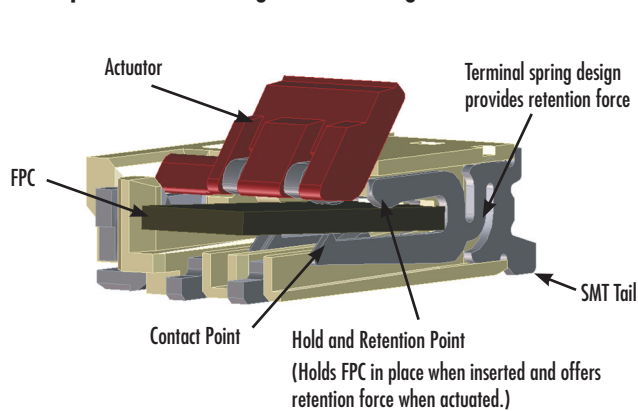

Alternating even spring terminals and odd stationary terminals provide opposing forces for high FPC retention force.

## SELECTION MATRIX

	Description	Order No.	Circuits	Plating (Terminal/Solder Tab)	Material (Housing/Terminal)	Packaging
	Right Angle, SMT EasyOn™ Bottom Contact Height = 1.05mm (.041") FPC Thickness = 0.20mm (.008")	500797-**92	11, 15, 19, 23, 25, 27, 31, 33, 39, 41, 51	Gold/Tin	LCP (Glass-filled), UL 94V-0 / Copper Alloy	Embossed Tape

## APPLICATIONS

- Mobile Phones
- Digital Cameras
- Hand Held Devices
- GPS Systems
- MP3 Players
- Mini DVD Players



## INTRODUCTION

### 查询"500797"供应商

With a height of just 0.80mm (.031") and a depth of 3.20mm (.126"), the 501461 FPC series from Molex offers the smallest overall size available today.

This connector features two locking features for the FPC: actuator tangs lock into notches on the FPC cable; and friction locks on the actuator corners provide an audible click when fully engaged.

The 501461 series was designed for the backlighting of LCDs, but with its range of small circuit sizes can serve other applications as well.

#### Specifications:

- Current: 0.3A
- Voltage: 50V
- Circuit Size Range: 4-8
- Contact Resistance: 40 milliohms max.
- Insulation Resistance: 50 Megohms min.
- Dielectric Withstanding Voltage: AC250V
- Terminal Retention Force: 1.0N {0.1kgf} min.
- Durability: 20 Cycles



## 0.50mm (.020") Pitch FPC Connector 0.80mm (.031") Height 501461

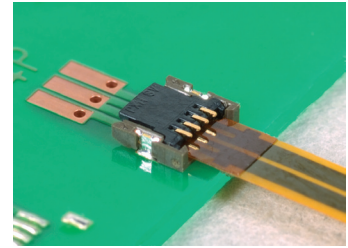

## FEATURES AND BENEFITS

### Two Types of Locking Features

#### Friction Actuator Lock

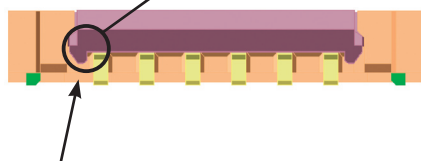
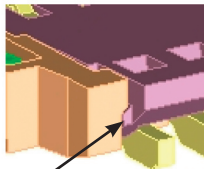

Friction locks provide audible click

#### FPC Lock

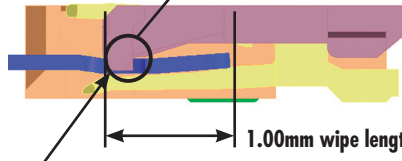

FPC lock for secure cable retention

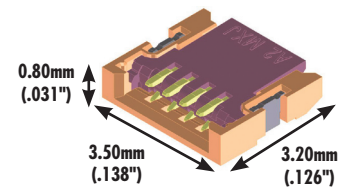

(4 Circuit)

Lowest profile and smallest footprint available today

## SELECTION MATRIX

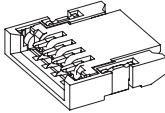
	Description	Order No.	Circuits	Plating (Terminal/Solder Tab)	Material (Housing/Terminal)	Packaging
	Right Angle, SMT BackFlip™ Bottom Contact Height = 0.80mm (.031") FPC Thickness = 0.12mm (.005")	501461-**01	4, 5, 6, 8	Gold/Tin	46 Nylon (Glass-filled), UL 94V-0 / Copper Alloy	Embossed Tape



Bringing People & Technology Together, Worldwide<sup>SM</sup>

**Americas Headquarters**  
2222 Wellington Ct,  
Lisle, Illinois 60532 USA  
Tel: 1-800-78MOLEX  
amerinfo@molex.com

**Far East North Headquarters**  
Yamato, Kanagawa, Japan  
Tel: 81-462-65-2324  
feninfo@molex.com

**Far East South Headquarters**  
Jurong, Singapore  
Tel: 65-6-268-6868  
fesinfo@molex.com

**European Headquarters**  
Munich, Germany  
Tel: 49-89-413092-0  
eurinfo@molex.com

**Corporate Headquarters**  
2222 Wellington Ct,  
Lisle, Illinois 60532 USA  
Tel: 630-969-4550