

[查询"MC14530BCL"供应商](#)

Dual 5-Input Majority Logic Gate

The MC14530B dual five-input majority logic gate is constructed with P-channel and N-channel enhancement mode devices in a single monolithic structure. Combinational and sequential logic expressions are easily implemented with the majority logic gate, often resulting in fewer components than obtainable with the more basic gates. This device can also provide numerous logic functions by using the W and some of the logic (A thru E) inputs as control inputs.

- Diode Protection on All Inputs
- Supply Voltage Range = 3.0 Vdc to 18 Vdc
- Capable of Driving Two Low-power TTL Loads or One Low-power Schottky TTL Load Over the Rated Temperature Range

MAXIMUM RATINGS* (Voltages Referenced to V_{SS})

Symbol	Parameter	Value	Unit
V _{DD}	DC Supply Voltage	- 0.5 to + 18.0	V
V _{in} , V _{out}	Input or Output Voltage (DC or Transient)	- 0.5 to V _{DD} + 0.5	V
I _{in} , I _{out}	Input or Output Current (DC or Transient), per Pin	± 10	mA
P _D	Power Dissipation, per Package†	500	mW
T _{stg}	Storage Temperature	- 65 to + 150	°C
T _L	Lead Temperature (8-Second Soldering)	260	°C

* Maximum Ratings are those values beyond which damage to the device may occur.

† Temperature Derating:

Plastic "P and D/DW" Packages: - 7.0 mW/°C From 65°C To 125°C
Ceramic "L" Packages: - 12 mW/°C From 100°C To 125°C

LOGIC TABLE

INPUTS A B C D E	W	Z
For all combinations of inputs where three or more inputs are logical "0".	0	1
	1	0
For all combinations of inputs where three or more inputs are logical "1".	0	0
	1	1

This device contains protection circuitry to guard against damage due to high static voltages or electric fields. However, precautions must be taken to avoid applications of any voltage higher than maximum rated voltages to this high-impedance circuit. For proper operation, V_{in} and V_{out} should be constrained to the range V_{SS} ≤ (V_{in} or V_{out}) ≤ V_{DD}. Unused inputs must always be tied to an appropriate logic voltage level (e.g., either V_{SS} or V_{DD}). Unused outputs must be left open.

MC14530B

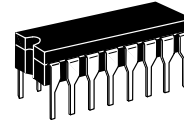

L SUFFIX
CERAMIC
CASE 620

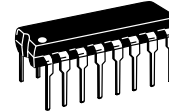

P SUFFIX
PLASTIC
CASE 648

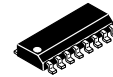

D SUFFIX
SOIC
CASE 751B

ORDERING INFORMATION

MC14XXXBCP Plastic
MC14XXXBCL Ceramic
MC14XXXBD SOIC

T_A = - 55° to 125°C for all packages.

BLOCK DIAGRAM

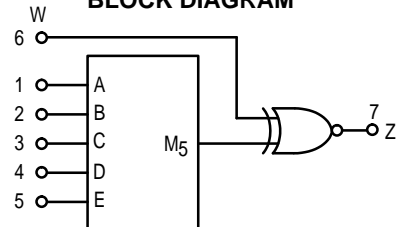

$$* Z = M_5 \odot W = (ABC+ABD+ABE+ACD+ACE+ADE+BCD+BCE+BDE+CDE) \odot W$$

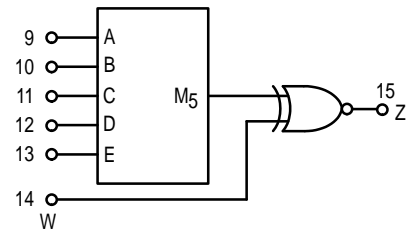

* M₅ is a logical "1" if any three or more inputs are logical "1".

⊙ ≡ Exclusive NOR ≡ Exclusive OR

TRUTH TABLE

M ₅	W	Z
0	0	1
0	1	0
1	0	0
1	1	1

V_{DD} = PIN 16
V_{SS} = PIN 8

ELECTRICAL CHARACTERISTICS (Voltages Referenced to V_{SS})

Characteristic	Symbol	V _{DD} Vdc	- 55°C		25°C			125°C		Unit	
			Min	Max	Min	Typ #	Max	Min	Max		
Output Voltage V _{in} = V _{DD} or 0	“0” Level V _{OL}	5.0	—	0.05	—	0	0.05	—	0.05	Vdc	
		10	—	0.05	—	0	0.05	—	0.05		
15		—	0.05	—	0	0.05	—	0.05			
V _{in} = 0 or V _{DD}	“1” Level V _{OH}	5.0	4.95	—	4.95	5.0	—	4.95	—	Vdc	
		10	9.95	—	9.95	10	—	9.95	—		
		15	14.95	—	14.95	15	—	14.95	—		
Input Voltage (V _O = 4.5 or 0.5 Vdc) (V _O = 9.0 or 1.0 Vdc) (V _O = 13.5 or 1.5 Vdc)	“0” Level V _{IL}	5.0	—	1.2	—	2.25	1.25	—	1.15	Vdc	
		10	—	2.5	—	4.50	2.5	—	2.4		
		15	—	3.0	—	6.75	3.0	—	2.9		
	“1” Level (V _O = 0.5 or 4.5 Vdc) (V _O = 1.0 or 9.0 Vdc) (V _O = 1.5 or 13.5 Vdc)	V _{IH}	5.0	3.85	—	3.75	2.75	—	3.75	—	Vdc
			10	7.6	—	7.5	5.50	—	7.5	—	
			15	12.1	—	12	8.25	—	12	—	
Output Drive Current (V _{OH} = 2.5 Vdc) (V _{OH} = 4.6 Vdc) (V _{OH} = 9.5 Vdc) (V _{OH} = 13.5 Vdc)	Source I _{OH}	5.0	- 3.0	—	- 2.4	- 4.2	—	- 1.7	—	mA _{dc}	
		5.0	- 0.64	—	- 0.51	- 0.88	—	- 0.36	—		
		10	- 1.6	—	- 1.3	- 2.25	—	- 0.9	—		
		15	- 4.2	—	- 3.4	- 8.8	—	- 2.4	—		
	Sink I _{OL}	5.0	0.64	—	0.51	0.88	—	0.36	—	mA _{dc}	
		10	1.6	—	1.3	2.25	—	0.9	—		
15	4.2	—	3.4	8.8	—	2.4	—	—			
Input Current	I _{in}	15	—	± 0.1	—	± 0.00001	± 0.1	—	± 1.0	μA _{dc}	
Input Capacitance (V _{in} = 0)	C _{in}	—	—	—	—	5.0	7.5	—	—	pF	
Quiescent Current (Per Package)	I _{DD}	5.0	—	0.25	—	0.0005	0.25	—	7.5	μA _{dc}	
		10	—	0.5	—	0.0010	0.5	—	15		
		15	—	1.0	—	0.0015	1.0	—	30		
Total Supply Current**† (Dynamic plus Quiescent, Per Package) (C _L = 50 pF on all outputs, all buffers switching)	I _T	5.0	I _T = (0.75 μA/kHz) f + I _{DD}							μA _{dc}	
10	I _T = (1.50 μA/kHz) f + I _{DD}										
15	I _T = (2.25 μA/kHz) f + I _{DD}										

#Data labelled “Typ” is not to be used for design purposes but is intended as an indication of the IC’s potential performance.

**The formulas given are for the typical characteristics only at 25°C.

* To calculate total supply current at loads other than 50 pF:

$$I_T(C_L) = I_T(50 \text{ pF}) + (C_L - 50) Vfk$$

where: I_T is in μA (per package), C_L in pF, V = (V_{DD} - V_{SS}) in volts, f in kHz is input frequency, and k = 0.002.

PIN ASSIGNMENT

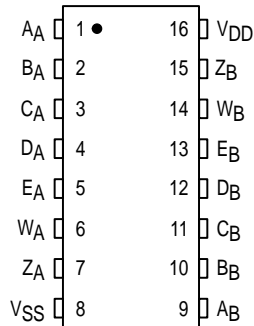

SEQUENTIAL LOGIC APPLICATIONS

[查询"MC14530BCL"供应商](#)

COINCIDENT FLIP-FLOP

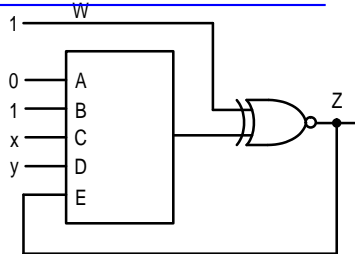

x	y	Q_{n+1}
0	0	0
0	1	Q
0	0	Q
1	1	1

A flip-flop that will change only when both inputs agree.

ASTABLE MULTIVIBRATOR

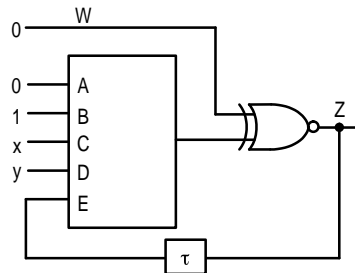

x	y	Q_{n+1}
0	0	1
0	1	2τ
1	0	2τ
1	1	1

A flip-flop with three output conditions, where the third state is in oscillation between "1" and "0". The period of oscillation is twice the delay of the gate and the feedback element.

COINCIDENT FLIP-FLOP

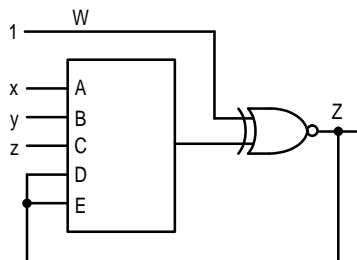

t_x	y	z	Q_{n+1}
0	0	0	0
0	0	1	Q_n
0	1	0	Q_n
0	1	1	Q_n
1	0	0	Q_n
1	0	1	Q_n
1	1	0	Q_n
1	1	1	1

The flip-flop changes state only when all "1's" or all "0's" are entered. This configuration may be extended by cascading M₅ gates to cover n-inputs where all inputs must be "1's" or "0's" before the output will change. As an example, this configuration is useful for controlling an n-stage up/down counter that is to cycle from a minimum to maximum count and back again without flipping over (from all "1's" to all "0's".)

BASIC COMBINATIONAL FUNCTIONS

查询"MC14530BCL"供应商

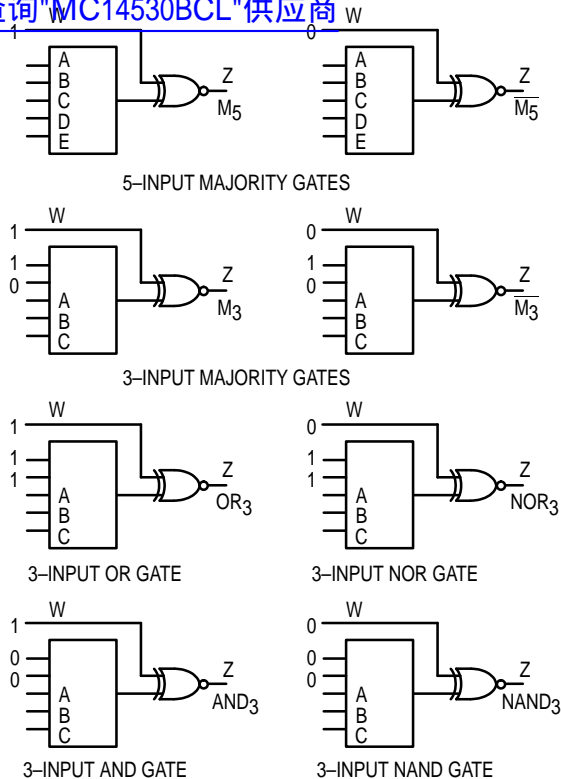

DOUBLING THE WEIGHT OF INPUT VARIABLE A BY TYING IT TO ANY TWO INPUTS

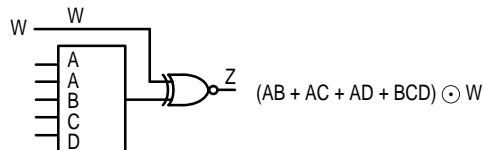

CORRELATION OF MULTIPLE SAMPLES WITH A TEST BIT

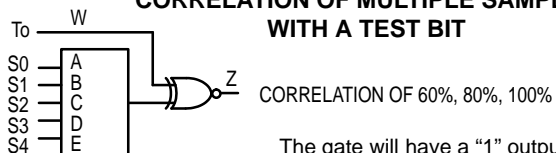

The gate will have a "1" output if the test bit To matches or correlates with 3, 4 or 5 of the sample bits S0-S4.

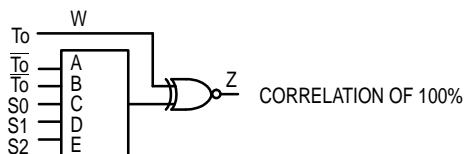
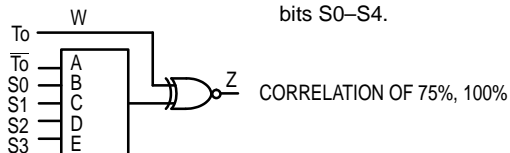

5-INPUT MAJORITY LOGIC GATE APPLICATIONS

Each package labeled M₅ is a single majority logic gate using five inputs, A thru E, and one output Z.

1. Majority Logic Gate Array yielding the symmetric function of 1 thru 7 variables true, out of 7 input variables (X1... X7)

(e.g., if any two-input variables are true (logical "1"), Z1 and Z2 are true (logical "1"))

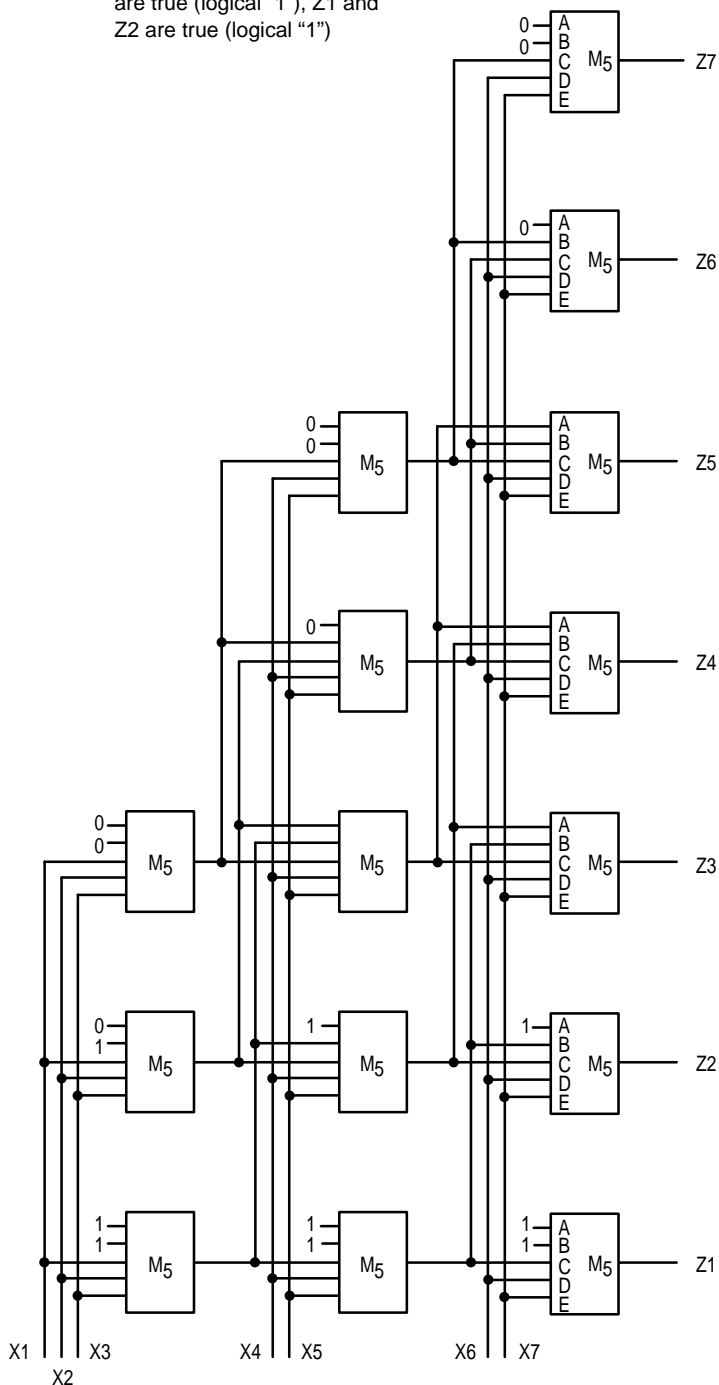

OUTLINE DIMENSIONS

查询"MC14530BCL"供应商

D SUFFIX PLASTIC SOIC PACKAGE CASE 751B-05 ISSUE J

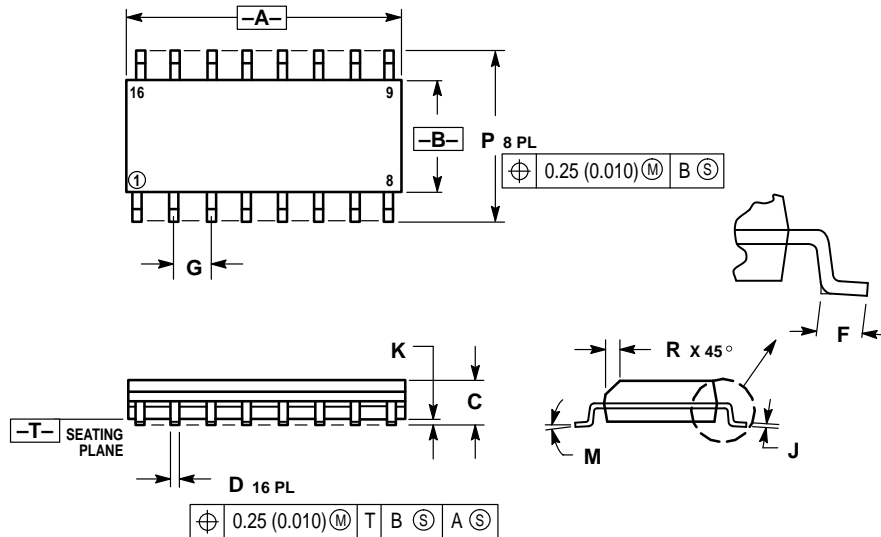

NOTES:

1. DIMENSIONING AND TOLERANCING PER ANSI Y14.5M, 1982.
2. CONTROLLING DIMENSION: MILLIMETER.
3. DIMENSIONS A AND B DO NOT INCLUDE MOLD PROTRUSION.
4. MAXIMUM MOLD PROTRUSION 0.15 (0.006) PER SIDE.
5. DIMENSION D DOES NOT INCLUDE DAMBAR PROTRUSION. ALLOWABLE DAMBAR PROTRUSION SHALL BE 0.127 (0.005) TOTAL IN EXCESS OF THE D DIMENSION AT MAXIMUM MATERIAL CONDITION.

DIM	MILLIMETERS		INCHES	
	MIN	MAX	MIN	MAX
A	9.80	10.00	0.386	0.393
B	3.80	4.00	0.150	0.157
C	1.35	1.75	0.054	0.068
D	0.35	0.49	0.014	0.019
F	0.40	1.25	0.016	0.049
G	1.27 BSC		0.050 BSC	
J	0.19	0.25	0.008	0.009
K	0.10	0.25	0.004	0.009
M	0° - 7°		0° - 7°	
P	5.80	6.20	0.229	0.244
R	0.25	0.50	0.010	0.019

Motorola reserves the right to make changes without further notice to any products herein. Motorola makes no warranty, representation or guarantee regarding the suitability of its products for any particular purpose, nor does Motorola assume any liability arising out of the application or use of any product or circuit, and specifically disclaims any and all liability, including without limitation consequential or incidental damages. "Typical" parameters which may be provided in Motorola data sheets and/or specifications can and do vary in different applications and actual performance may vary over time. All operating parameters, including "Typicals" must be validated for each customer application by customer's technical experts. Motorola does not convey any license under its patent rights nor the rights of others. Motorola products are not designed, intended, or authorized for use as components in systems intended for surgical implant into the body, or other applications intended to support or sustain life, or for any other application in which the failure of the Motorola product could create a situation where personal injury or death may occur. Should Buyer purchase or use Motorola products for any such unintended or unauthorized application, Buyer shall indemnify and hold Motorola and its officers, employees, subsidiaries, affiliates, and distributors harmless against all claims, costs, damages, and expenses, and reasonable attorney fees arising out of, directly or indirectly, any claim of personal injury or death associated with such unintended or unauthorized use, even if such claim alleges that Motorola was negligent regarding the design or manufacture of the part. Motorola and are registered trademarks of Motorola, Inc. Motorola, Inc. is an Equal Opportunity/Affirmative Action Employer.

How to reach us:

USA/EUROPE/Locations Not Listed: Motorola Literature Distribution;
P.O. Box 20912; Phoenix, Arizona 85036. 1-800-441-2447 or 602-303-5454

JAPAN: Nippon Motorola Ltd.; Tatsumi-SPD-JLDC, 6F Seibu-Butsuryu-Center,
3-14-2 Tatsumi Koto-Ku, Tokyo 135, Japan. 03-81-3521-8315

MFAX: RMFAX0@email.sps.mot.com - TOUCHTONE 602-244-6609
INTERNET: http://Design-NET.com

ASIA/PACIFIC: Motorola Semiconductors H.K. Ltd.; 8B Tai Ping Industrial Park,
51 Ting Kok Road, Tai Po, N.T., Hong Kong. 852-26629298



MC14530B/D

