

# Gallium Arsenide PHEMT

## RF Power Field Effect Transistor

Designed for WLL/MMDS/BWA or UMTS driver applications with frequencies from 500 to 5000 MHz. Device is unmatched and is suitable for use in Class AB Customer Premise Equipment (CPE) applications.

- Typical Single-Carrier W-CDMA Performance:  $V_{DD} = 6$  Volts,  $I_{DQ} = 180$  mA,  $P_{out} = 450$  mWatts Avg., 3550 MHz, Channel Bandwidth = 3.84 MHz, PAR = 8.5 dB @ 0.01% Probability on CCDF.  
 Power Gain — 10 dB  
 Drain Efficiency — 27%  
 ACPR @ 5 MHz Offset — -42.5 dBc in 3.84 MHz Channel Bandwidth
- 3 Watts P1dB @ 3550 MHz, CW

### Features

- Excellent Phase Linearity and Group Delay Characteristics
- High Gain, High Efficiency and High Linearity
- RoHS Compliant
- In Tape and Reel. T1 Suffix = 1000 Units per 12 mm, 7 inch Reel.

**MRFG35003N6AT1**

**3.5 GHz, 3 W, 6 V  
 POWER FET  
 GaAs PHEMT**

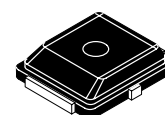

**CASE 466-03, STYLE 1  
 PLD-1.5  
 PLASTIC**

**Table 1. Maximum Ratings**

Rating	Symbol	Value	Unit
Drain-Source Voltage	$V_{DSS}$	8	Vdc
Gate-Source Voltage	$V_{GS}$	-5	Vdc
RF Input Power	$P_{in}$	24	dBm
Storage Temperature Range	$T_{stg}$	-65 to +150	°C
Channel Temperature (1)	$T_{ch}$	175	°C

**Table 2. Thermal Characteristics**

Characteristic	Symbol	Value (2)	Unit
Thermal Resistance, Junction to Case	$R_{\theta JC}$	5.9	°C/W

**Table 3. ESD Protection Characteristics**

Test Methodology	Class
Human Body Model (per JESD22-A114)	2 (Minimum)
Machine Model (per EIA/JESD22-A115)	A (Minimum)
Charge Device Model (per JESD22-C101)	IV (Minimum)

**Table 4. Moisture Sensitivity Level**

Test Methodology	Rating	Package Peak Temperature	Unit
Per JESD22-A113, IPC/JEDEC J-STD-020	3	260	°C

1. For reliable operation, the operating channel temperature should not exceed 150°C.
2. Refer to AN1955, *Thermal Measurement Methodology of RF Power Amplifiers*. Go to <http://www.freescale.com/rf>. Select Documentation/Application Notes - AN1955.

**Table 5. Electrical Characteristics** ( $T_A = 25^\circ\text{C}$  unless otherwise noted)

Characteristic	Symbol	Min	Typ	Max	Unit
Saturated Drain Current ( $V_{DS} = 3.5\text{ Vdc}$ , $V_{GS} = 0\text{ Vdc}$ )	$I_{DSS}$	—	2.9	—	Adc
Off State Leakage Current ( $V_{GS} = -0.4\text{ Vdc}$ , $V_{DS} = 0\text{ Vdc}$ )	$I_{GSS}$	—	< 1	100	$\mu\text{Adc}$
Off State Drain Current ( $V_{DS} = 6\text{ Vdc}$ , $V_{GS} = -2.2\text{ Vdc}$ )	$I_{DSO}$	—	50	1000	$\mu\text{Adc}$
Off State Current ( $V_{DS} = 20\text{ Vdc}$ , $V_{GS} = -2.5\text{ Vdc}$ )	$I_{DSX}$	—	< 1	15	mAdc
Gate-Source Cut-off Voltage ( $V_{DS} = 3.5\text{ Vdc}$ , $I_{DS} = 15\text{ mA}$ )	$V_{GS(th)}$	-1.2	-0.95	-0.7	Vdc
Quiescent Gate Voltage ( $V_{DS} = 6\text{ Vdc}$ , $I_D = 180\text{ mA}$ )	$V_{GS(Q)}$	-1.1	-0.82	-0.6	Vdc

**Functional Tests** (In Freescale Test Fixture, 50 ohm system)  $V_{DD} = 6\text{ Vdc}$ ,  $I_{DQ} = 180\text{ mA}$ ,  $P_{out} = 450\text{ mWatts Avg.}$ ,  $f = 3550\text{ MHz}$ , Single-Carrier W-CDMA, 3.84 MHz Channel Bandwidth Carrier. ACPR measured in 3.84 MHz Channel Bandwidth @  $\pm 5\text{ MHz}$  Offset. PAR = 8.5 dB @ 0.01% Probability on CCDF.

Power Gain	$G_{ps}$	8	10	—	dB
Drain Efficiency	$\eta_D$	22	27	—	%
Adjacent Channel Power Ratio	ACPR	—	-42.5	-38	dBc

**Typical RF Performance** (In Freescale Test Fixture, 50 ohm system)  $V_{DD} = 6\text{ Vdc}$ ,  $I_{DQ} = 180\text{ mA}$ ,  $f = 3550\text{ MHz}$

Output Power, 1 dB Compression Point, CW	$P_{1dB}$	—	3	—	W
--	-----------	---	---	---	---

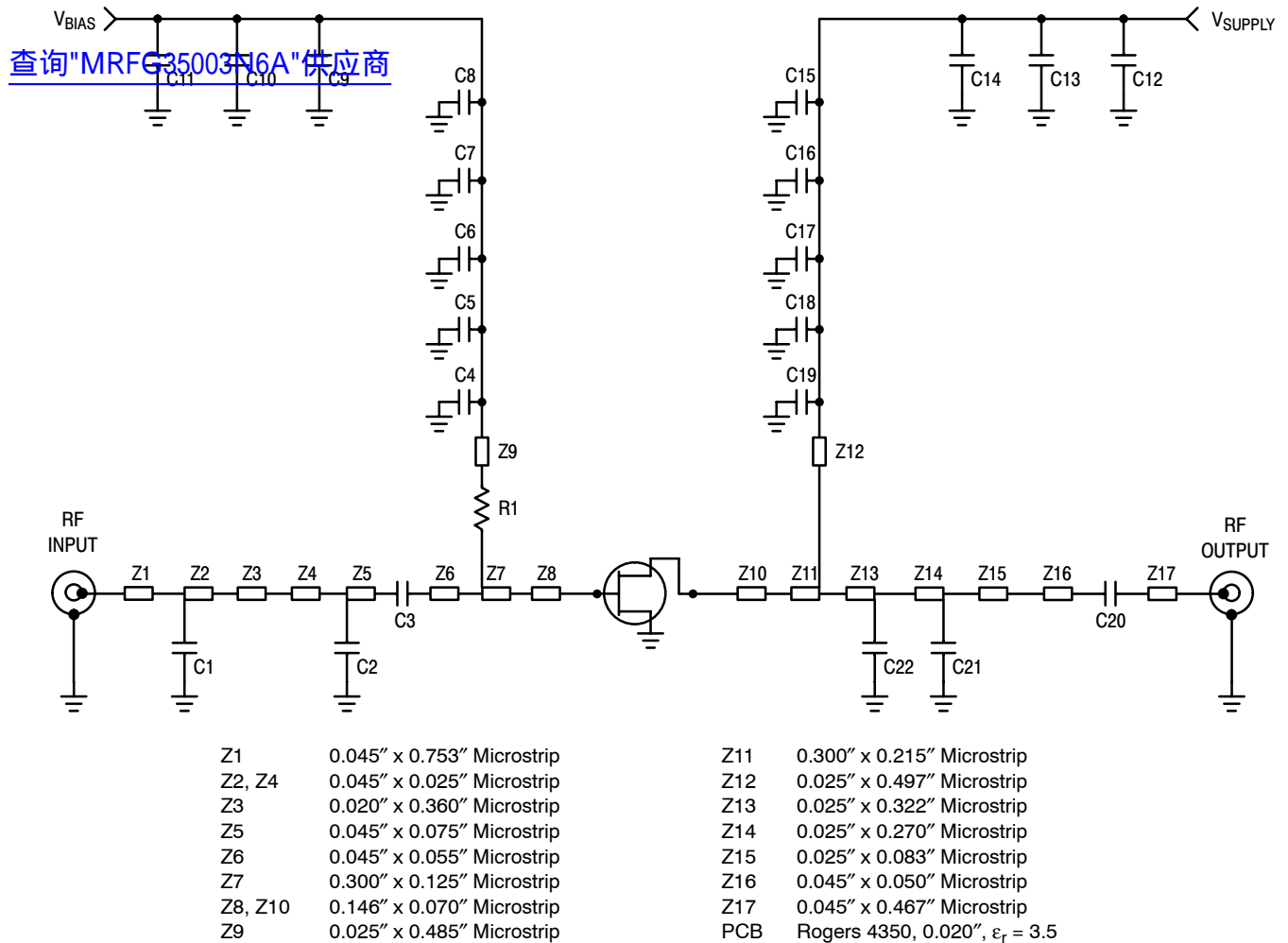

Figure 1. MRFG35003N6A Test Circuit Schematic

Table 6. MRFG35003N6A Test Circuit Component Designations and Values

Part	Description	Part Number	Manufacturer
C1	0.5 pF Chip Capacitor	08051J0R5BBS	AVX
C2	0.4 pF Chip Capacitor	06035J0R4BBS	AVX
C3	0.5 pF Chip Capacitor	06035J0R5BBS	AVX
C4, C19, C20	6.8 pF Chip Capacitors	08051J6R8BBS	AVX
C5, C18	10 pF Chip Capacitors	ATC100A100JT150XT	ATC
C6, C17	100 pF Chip Capacitors	ATC100A101JT150XT	ATC
C7, C16	100 pF Chip Capacitors	ATC100B101JT500XT	ATC
C8, C15	1000 pF Chip Capacitors	ATC100B102JT50XT	ATC
C9, C14	0.01 $\mu$ F Chip Capacitors	ATC200B103KT50XT	ATC
C10, C13	39K pF Chip Capacitors	ATC200B393KT50XT	ATC
C11, C12	10 $\mu$ F, 50 V Chip Capacitors	GRM55DR61H106KA88B	Murata
C21, C22	0.7 pF Chip Capacitors	08051J0R7BBS	AVX
R1	50 $\Omega$ Chip Resistor	CRCW040250R0FKTA	Vishay

查询"MRFG35003N6A"供应商

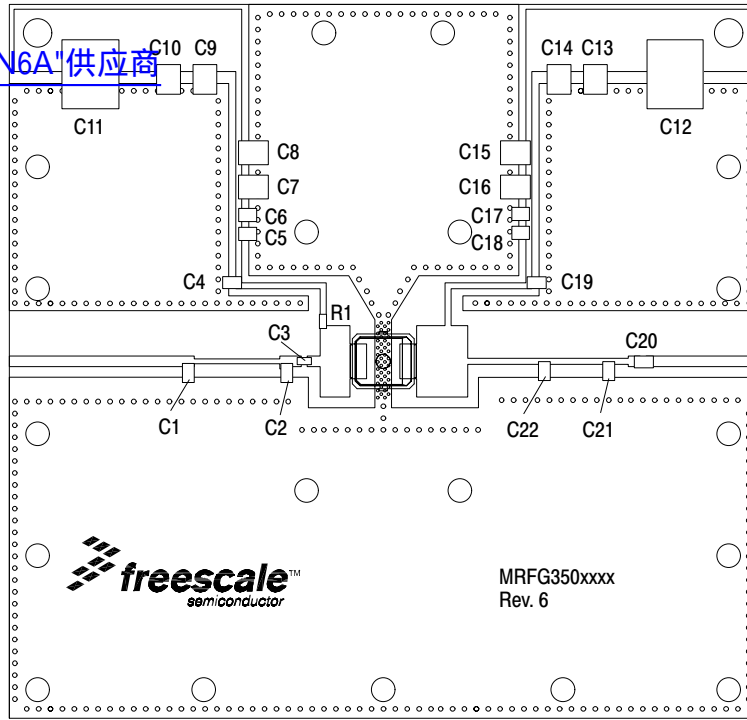
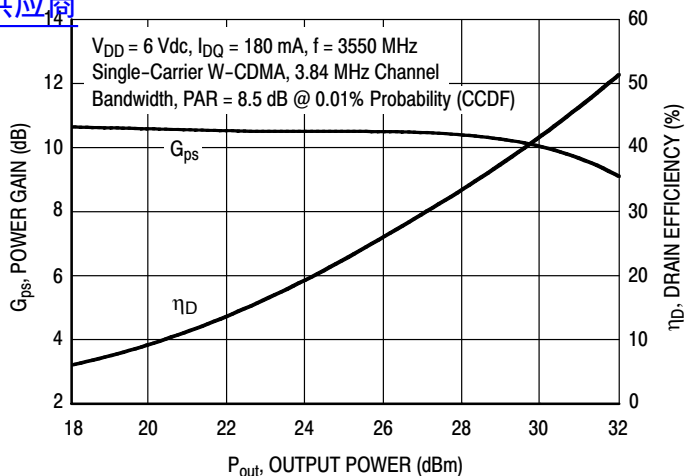

Figure 2. MRFG35003N6A Test Circuit Component Layout

## TYPICAL CHARACTERISTICS

[查询"MRFG35003N6A"供应商](#)



**Figure 3. Single-Channel W-CDMA Power Gain and Drain Efficiency versus Output Power**

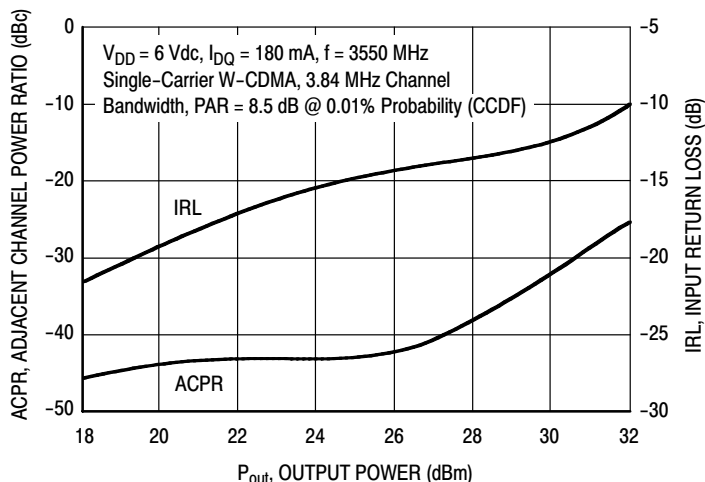

**Figure 4. Single-Channel W-CDMA Adjacent Channel Power Ratio and IRL versus Output Power**

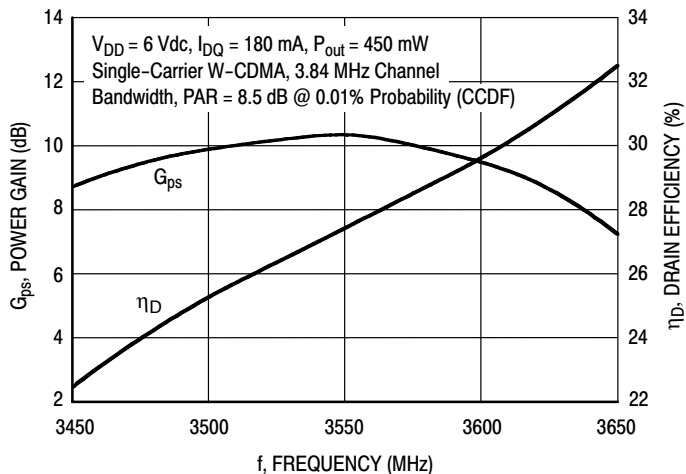
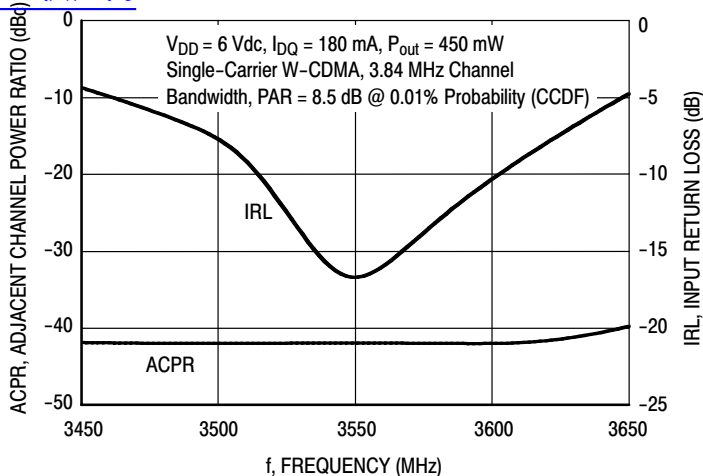

**Figure 5. Single-Channel W-CDMA Power Gain and Drain Efficiency versus Frequency**

**NOTE:** Data is generated from the test circuit shown.

## TYPICAL CHARACTERISTICS

[查询"MRFG35003N6A"供应商](#)



**Figure 6. Single-Channel W-CDMA Adjacent Channel Power Ratio and IRL versus Frequency**

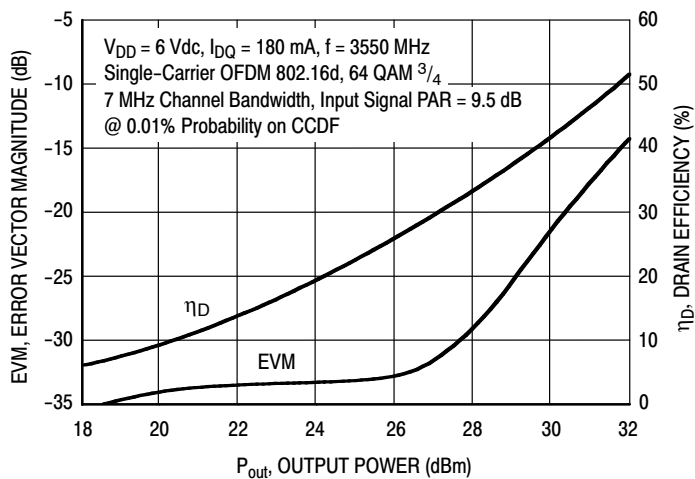

**Figure 7. Single-Channel OFDM Error Vector Magnitude and Drain Efficiency versus Output Power**

**NOTE:** Data is generated from the test circuit shown.

**Table 7. Common Source S-Parameters** ( $V_{DD} = 6 \text{ Vdc}$ ,  $I_{DQ} = 180 \text{ mA}$ ,  $T_A = 25^\circ\text{C}$ , 50 Ohm System)

查询"MRFG35003N6AT"供应商			$S_{21}$		$S_{12}$		$S_{22}$	
MHz	$ S_{11} $	$\angle \phi$	$ S_{21} $	$\angle \phi$	$ S_{12} $	$\angle \phi$	$ S_{22} $	$\angle \phi$
500	0.952	-178.5	3.658	83.3	0.017	4.87	0.844	177.9
550	0.952	-179.7	3.336	82.0	0.017	4.61	0.845	177.3
600	0.952	179.2	3.062	80.7	0.017	4.46	0.845	176.8
650	0.952	178.2	2.832	79.4	0.018	4.25	0.845	176.2
700	0.952	177.2	2.627	78.2	0.018	4.15	0.845	175.7
750	0.952	176.3	2.451	77.0	0.018	4.03	0.844	175.1
800	0.952	175.4	2.304	75.8	0.018	3.89	0.844	174.6
850	0.952	174.6	2.175	74.7	0.018	3.79	0.845	174.1
900	0.952	173.9	2.062	73.5	0.018	3.72	0.845	173.6
950	0.952	173.1	1.955	72.4	0.018	3.66	0.845	173.1
1000	0.952	172.3	1.857	71.3	0.018	3.53	0.845	172.6
1050	0.951	171.6	1.769	70.1	0.018	3.39	0.845	172.1
1100	0.951	170.9	1.696	69.0	0.018	3.25	0.845	171.6
1150	0.952	170.3	1.631	68.0	0.018	3.11	0.845	171.1
1200	0.951	169.6	1.567	66.8	0.018	2.90	0.845	170.6
1250	0.951	168.9	1.508	65.8	0.018	2.78	0.845	170.0
1300	0.951	168.3	1.453	64.7	0.018	2.76	0.844	169.5
1350	0.951	167.7	1.403	63.6	0.018	2.70	0.844	168.9
1400	0.951	167.1	1.360	62.5	0.019	2.56	0.843	168.4
1450	0.950	166.5	1.319	61.4	0.019	2.46	0.843	167.8
1500	0.950	166.0	1.308	60.0	0.019	2.11	0.839	166.5
1550	0.950	165.7	1.267	59.0	0.019	2.15	0.839	165.8
1600	0.950	165.3	1.226	58.0	0.019	2.11	0.840	165.2
1650	0.950	164.9	1.189	57.0	0.019	2.13	0.840	164.5
1700	0.950	164.4	1.154	56.0	0.019	2.02	0.841	164.0
1750	0.950	164.0	1.123	54.9	0.019	1.89	0.841	163.5
1800	0.949	163.4	1.093	53.9	0.019	1.83	0.842	163.0
1850	0.949	162.9	1.065	52.9	0.020	1.75	0.842	162.6
1900	0.949	162.3	1.039	51.9	0.020	1.58	0.842	162.1
1950	0.948	161.7	1.014	50.9	0.020	1.45	0.841	161.7
2000	0.948	161.1	0.991	49.9	0.020	1.27	0.841	161.3
2050	0.948	160.5	0.970	48.8	0.020	1.15	0.842	160.9
2100	0.948	159.8	0.950	47.8	0.020	0.98	0.841	160.5
2150	0.947	159.2	0.931	46.8	0.020	0.83	0.841	160.1
2200	0.947	158.5	0.914	45.8	0.020	0.64	0.841	159.8
2250	0.947	157.7	0.897	44.7	0.020	0.39	0.841	159.4
2300	0.947	156.9	0.883	43.6	0.021	0.13	0.839	159.1
2350	0.946	156.1	0.869	42.6	0.021	-0.13	0.839	158.8
2400	0.946	155.3	0.857	41.5	0.021	-0.44	0.838	158.4
2450	0.945	154.4	0.845	40.4	0.021	-0.82	0.838	158.1
2500	0.945	153.5	0.835	39.2	0.021	-1.20	0.836	157.8
2550	0.944	152.6	0.825	38.1	0.022	-1.58	0.835	157.4
2600	0.944	151.7	0.816	37.0	0.022	-1.95	0.833	157.0
2650	0.944	150.9	0.808	35.9	0.022	-2.32	0.832	156.5
2700	0.943	150.0	0.800	34.7	0.022	-2.71	0.831	156.1
2750	0.942	149.0	0.793	33.5	0.023	-3.10	0.830	155.6

(continued)

MRFG35003N6AT1

**Table 7. Common Source S-Parameters** ( $V_{DD} = 6 \text{ Vdc}$ ,  $I_{DQ} = 180 \text{ mA}$ ,  $T_A = 25^\circ\text{C}$ , 50 Ohm System) (continued)

MHz	S <sub>11</sub>		S <sub>21</sub>		S <sub>12</sub>		S <sub>22</sub>	
	S <sub>11</sub>	∠φ	S <sub>21</sub>	∠φ	S <sub>12</sub>	∠φ	S <sub>22</sub>	∠φ
2800	0.942	148.1	0.787	32.3	0.023	-3.45	0.828	155.1
2850	0.941	147.2	0.780	31.1	0.023	-3.81	0.826	154.6
2900	0.941	146.3	0.775	29.9	0.023	-4.24	0.824	154.0
2950	0.940	145.4	0.770	28.6	0.024	-4.68	0.822	153.3
3000	0.940	144.6	0.766	27.4	0.024	-5.11	0.821	152.6
3050	0.939	143.8	0.761	26.2	0.024	-5.52	0.819	151.8
3100	0.938	143.0	0.757	25.0	0.025	-5.90	0.818	151.0
3150	0.938	142.3	0.752	23.7	0.025	-6.24	0.816	150.1
3200	0.937	141.7	0.748	22.5	0.025	-6.70	0.814	149.2
3250	0.937	141.1	0.745	21.3	0.026	-7.22	0.813	148.2
3300	0.937	140.5	0.740	20.1	0.026	-7.78	0.813	147.3
3350	0.936	139.9	0.736	18.9	0.027	-8.32	0.811	146.3
3400	0.935	139.3	0.732	17.7	0.027	-8.86	0.810	145.4
3450	0.934	138.8	0.728	16.5	0.027	-9.47	0.809	144.5
3500	0.934	138.2	0.723	15.3	0.028	-10.00	0.808	143.6
3550	0.933	137.6	0.720	14.1	0.028	-10.60	0.807	142.7
3600	0.932	137.0	0.716	13.0	0.028	-11.16	0.807	141.9
3650	0.932	136.4	0.712	11.8	0.028	-11.65	0.807	141.1
3700	0.930	135.8	0.708	10.7	0.029	-12.05	0.807	140.3
3750	0.929	135.1	0.704	9.6	0.029	-12.48	0.806	139.6
3800	0.928	134.5	0.700	8.5	0.029	-12.78	0.806	138.9
3850	0.928	133.9	0.696	7.4	0.029	-13.03	0.805	138.3
3900	0.927	133.2	0.693	6.3	0.030	-13.30	0.804	137.6
3950	0.926	132.6	0.690	5.2	0.030	-13.55	0.804	137.0
4000	0.926	131.8	0.687	4.1	0.030	-13.84	0.802	136.4
4050	0.925	131.1	0.684	3.1	0.030	-14.13	0.801	135.8
4100	0.924	130.4	0.681	1.9	0.031	-14.34	0.799	135.1
4150	0.923	129.7	0.679	0.8	0.031	-14.45	0.798	134.5
4200	0.921	128.9	0.677	-0.2	0.031	-14.48	0.797	134.0
4250	0.920	128.1	0.676	-1.4	0.032	-14.65	0.797	133.4
4300	0.917	127.2	0.675	-2.5	0.032	-14.76	0.796	132.9
4350	0.917	126.3	0.674	-3.7	0.033	-15.08	0.795	132.3
4400	0.916	125.4	0.673	-4.9	0.034	-15.50	0.792	131.8
4450	0.915	124.3	0.673	-6.1	0.034	-15.93	0.791	131.3
4500	0.913	123.2	0.673	-7.4	0.035	-16.40	0.788	130.8
4550	0.912	122.0	0.673	-8.7	0.035	-16.94	0.786	130.2
4600	0.910	120.7	0.674	-10.0	0.036	-17.54	0.783	129.7
4650	0.909	119.4	0.675	-11.4	0.037	-18.24	0.780	129.1
4700	0.908	118.0	0.676	-12.8	0.038	-18.93	0.777	128.6
4750	0.907	116.5	0.679	-14.3	0.038	-19.78	0.773	127.9
4800	0.905	115.0	0.681	-15.9	0.039	-20.65	0.771	127.2
4850	0.903	113.4	0.684	-17.4	0.040	-21.58	0.768	126.4
4900	0.901	111.8	0.686	-19.1	0.041	-22.66	0.765	125.6
4950	0.900	110.2	0.689	-20.7	0.042	-23.74	0.762	124.6
5000	0.898	108.6	0.692	-22.4	0.042	-24.86	0.757	123.6



PACKAGE DIMENSIONS

查询"MRFG35003N6A"供应商

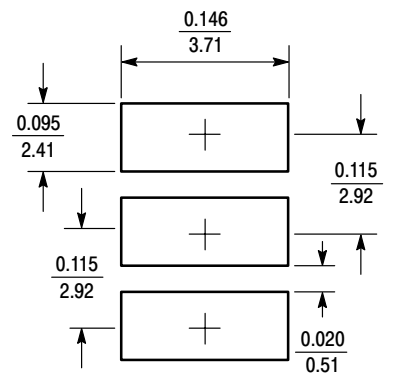
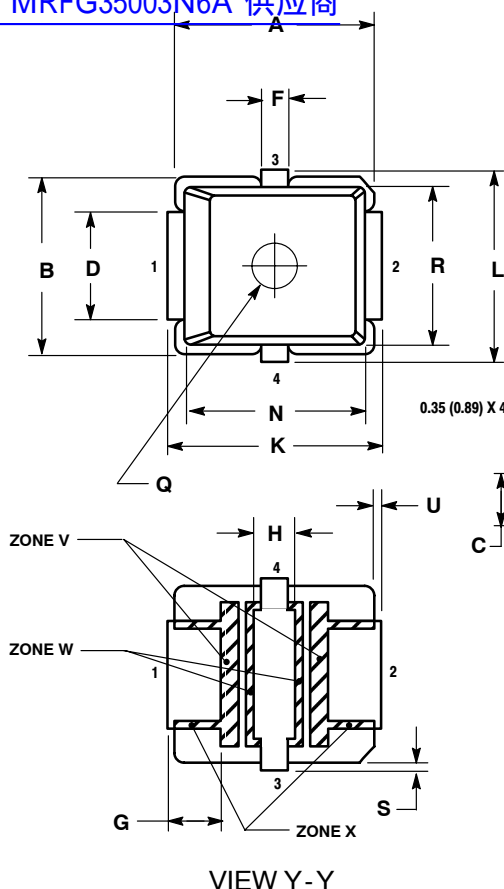

SOLDER FOOTPRINT

DIM	INCHES		MILLIMETERS	
	MIN	MAX	MIN	MAX
A	0.255	0.265	6.48	6.73
B	0.225	0.235	5.72	5.97
C	0.065	0.072	1.65	1.83
D	0.130	0.150	3.30	3.81
E	0.021	0.026	0.53	0.66
F	0.026	0.044	0.66	1.12
G	0.050	0.070	1.27	1.78
H	0.045	0.063	1.14	1.60
J	0.160	0.180	4.06	4.57
K	0.273	0.285	6.93	7.24
L	0.245	0.255	6.22	6.48
N	0.230	0.240	5.84	6.10
P	0.000	0.008	0.00	0.20
Q	0.055	0.063	1.40	1.60
R	0.200	0.210	5.08	5.33
S	0.006	0.012	0.15	0.31
U	0.006	0.012	0.15	0.31
ZONE V	0.000	0.021	0.00	0.53
ZONE W	0.000	0.010	0.00	0.25
ZONE X	0.000	0.010	0.00	0.25

- NOTES:
1. INTERPRET DIMENSIONS AND TOLERANCES PER ASME Y14.5M, 1984.
  2. CONTROLLING DIMENSION: INCH
  3. RESIN BLEED/FLASH ALLOWABLE IN ZONE V, W, AND X.
- STYLE 1:  
 PIN 1. DRAIN  
 2. GATE  
 3. SOURCE  
 4. SOURCE

CASE 466-03  
 ISSUE D  
 PLD-1.5  
 PLASTIC

## PRODUCT DOCUMENTATION

[查询"MRF35003N6A"供应商](#)  
Refer to the following documents to aid your design process.

### Application Notes

- AN1955: Thermal Measurement Methodology of RF Power Amplifiers

## REVISION HISTORY

The following table summarizes revisions to this document.

Revision	Date	Description
0	July 2007	<ul style="list-style-type: none"><li>• Initial Release of Data Sheet</li></ul>
1	Nov. 2008	<ul style="list-style-type: none"><li>• Removed "Operating Case Temperature Range" from Maximum Ratings table so that the maximum channel temperature rating is the limiting thermal design criteria and not the case temperature range, p. 1</li></ul>
2	June 2009	<ul style="list-style-type: none"><li>• Modified data sheet to reflect MSL rating change from 1 to 3 as a result of the standardization of packing process as described in Product and Process Change Notification number, PCN13516, p. 1</li></ul>

## **How to Reach Us:**

### **Home Page:**

[www.freescale.com](http://www.freescale.com)

### **Web Support:**

<http://www.freescale.com/support>

### **USA/Europe or Locations Not Listed:**

Freescale Semiconductor, Inc.  
Technical Information Center, EL516  
2100 East Elliot Road  
Tempe, Arizona 85284  
1-800-521-6274 or +1-480-768-2130  
[www.freescale.com/support](http://www.freescale.com/support)

### **Europe, Middle East, and Africa:**

Freescale Halbleiter Deutschland GmbH  
Technical Information Center  
Schatzbogen 7  
81829 Muenchen, Germany  
+44 1296 380 456 (English)  
+46 8 52200080 (English)  
+49 89 92103 559 (German)  
+33 1 69 35 48 48 (French)  
[www.freescale.com/support](http://www.freescale.com/support)

### **Japan:**

Freescale Semiconductor Japan Ltd.  
Headquarters  
ARCO Tower 15F  
1-8-1, Shimo-Meguro, Meguro-ku,  
Tokyo 153-0064  
Japan  
0120 191014 or +81 3 5437 9125  
[support.japan@freescale.com](mailto:support.japan@freescale.com)

### **Asia/Pacific:**

Freescale Semiconductor China Ltd.  
Exchange Building 23F  
No. 118 Jianguo Road  
Chaoyang District  
Beijing 100022  
China  
+86 10 5879 8000  
[support.asia@freescale.com](mailto:support.asia@freescale.com)

### **For Literature Requests Only:**

Freescale Semiconductor Literature Distribution Center  
1-800-441-2447 or +1-303-675-2140  
Fax: +1-303-675-2150  
[LDCForFreescaleSemiconductor@hibbertgroup.com](mailto:LDCForFreescaleSemiconductor@hibbertgroup.com)

Information in this document is provided solely to enable system and software implementers to use Freescale Semiconductor products. There are no express or implied copyright licenses granted hereunder to design or fabricate any integrated circuits or integrated circuits based on the information in this document.

Freescale Semiconductor reserves the right to make changes without further notice to any products herein. Freescale Semiconductor makes no warranty, representation or guarantee regarding the suitability of its products for any particular purpose, nor does Freescale Semiconductor assume any liability arising out of the application or use of any product or circuit, and specifically disclaims any and all liability, including without limitation consequential or incidental damages. "Typical" parameters that may be provided in Freescale Semiconductor data sheets and/or specifications can and do vary in different applications and actual performance may vary over time. All operating parameters, including "Typicals", must be validated for each customer application by customer's technical experts. Freescale Semiconductor does not convey any license under its patent rights nor the rights of others. Freescale Semiconductor products are not designed, intended, or authorized for use as components in systems intended for surgical implant into the body, or other applications intended to support or sustain life, or for any other application in which the failure of the Freescale Semiconductor product could create a situation where personal injury or death may occur. Should Buyer purchase or use Freescale Semiconductor products for any such unintended or unauthorized application, Buyer shall indemnify and hold Freescale Semiconductor and its officers, employees, subsidiaries, affiliates, and distributors harmless against all claims, costs, damages, and expenses, and reasonable attorney fees arising out of, directly or indirectly, any claim of personal injury or death associated with such unintended or unauthorized use, even if such claim alleges that Freescale Semiconductor was negligent regarding the design or manufacture of the part.

Freescale™ and the Freescale logo are trademarks of Freescale Semiconductor, Inc. All other product or service names are the property of their respective owners.

© Freescale Semiconductor, Inc. 2007-2009. All rights reserved.

