

MINI TYPE LED LAMPS

小型化發光二極體指示

[查詢"BZW04-17B"供應商](#)

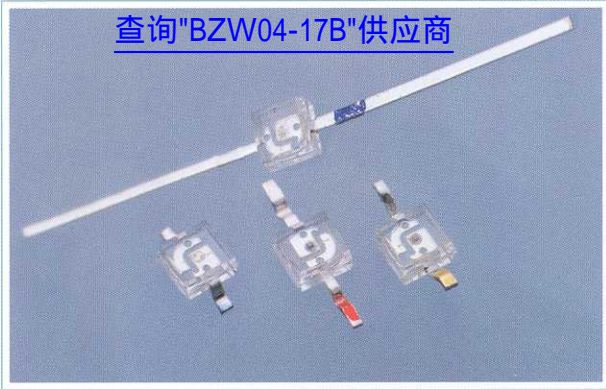

Recommended Soldering Pattern For Reflow Soldering

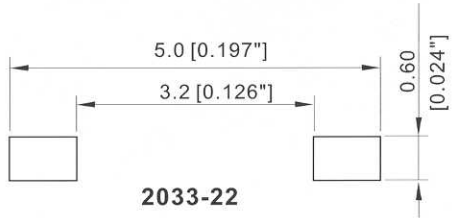

2033-22

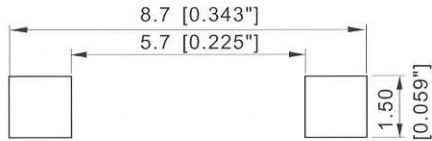

2033-23

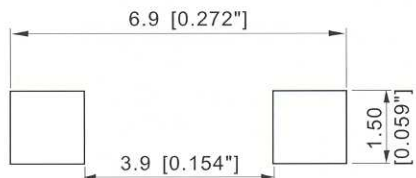

2033-24

Package Outline Drawing:

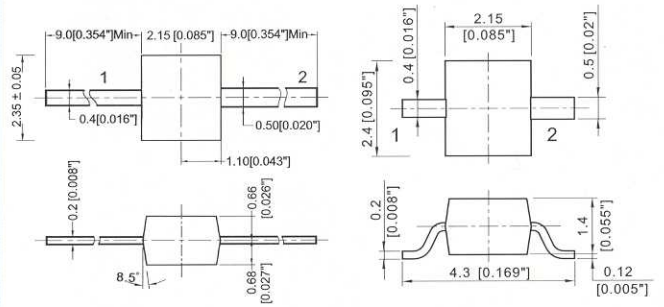

2033-21

2033-22

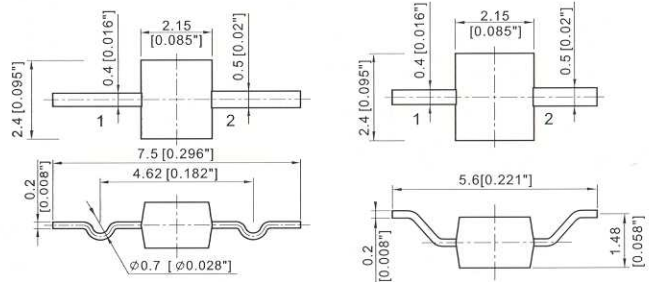

2033-23

2033-24

NOTES 1. All dimensions are in millimeters (inches);
2. Tolerances are ± 0.1 mm (0.004inch) unless otherwise noted;
3. Resin color: water clear.

Recommended Reflow Soldering Profile.

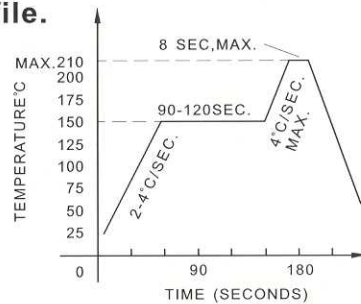

Axial Flat Top LEDs

Part Number	Raw Material	Wave Length λ D(nm)	Emitting color	Lens Type	Vf(V) Typ	Iv(mcd) Typ	Viewing angle $2\theta_{1/2}(\text{°})$
					At 20mA		
RF-RS2033TS-(21-24)E	GaAlAs	645	Red	Water Clear	1.8	15	135
RF-RU2033TP-(21-24)E	AlGaInP	630	Red	Water Clear	2.0	35	135
RF-OU2033TP-(21-24)E	AlGaInP	620	Orange	Water Clear	2.0	45	135
RF-YU2033TP-(21-24)E	AlGaInP	587	Yellow	Water Clear	2.0	45	135
RF-YG2033TP-(21-24)E	GaP	570	Yellow Green	Water Clear	2.3	12	135
RF-GP2033TP-(21-24)E	AllnGaN	525	Green	Water Clear	3.3	120	135
RF-BN2033TP-(21-24)E	AllnGaN	470	Blue	Water Clear	3.3	36	135
RF-WN2033TP-(21-24)E	AllnGaN		White	diffused	3.3	80	135