



900 MHz GaAs Low Noise Amplifier with Gain Control

Designed primarily for use in 900 MHz wireless communication systems such as GSM, AMPS, and Industrial, Scientific, and Medical (ISM) band applications. The MRFIC0930 is a two-stage low noise amplifier with an integrated step attenuator and is packaged in a low-cost SO-8 package. The MRFIC0930DM is packaged in the smaller Micro-8 package. The attenuator is controlled by a V_{gain} Pin. The LNA can be turned off during transmit mode to save current by using the Rx Enable Pin. The amplifier can be matched to optimize gain or noise figure with simple off-chip input matching.

- Usable Frequency Range = 800 to 1000 MHz
- 19 dB Typ Gain
- Gain Attenuation = 18 dB (Typ)
- 1.7 dB Typ Noise Figure
- Simple Off-chip Matching for Maximum Gain/Noise Figure Flexibility
- High Reverse Isolation = 41 dB (Typ)
- Low Power Consumption = 24 mW (Typ)
- Single Bias Supply = 2.7 to 4.5 V
- Low Standby Current = 20 μ A (Typ)
- Low Cost Surface Mount Plastic Package

MRFIC0930

900 MHz GaAs LOW NOISE AMPLIFIER WITH GAIN CONTROL

SEMICONDUCTOR TECHNICAL DATA

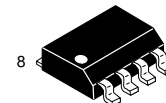

1
(Scale 2:1)

PLASTIC PACKAGE
CASE 751
(SO-8, Tape & Reel Only)

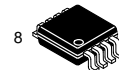

1
(Scale 2:1)

DM SUFFIX
PLASTIC PACKAGE
CASE 846A
(Micro-8, Tape & Reel Only)

PIN CONNECTIONS

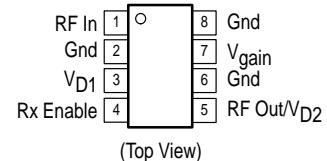

Simplified Block Diagram

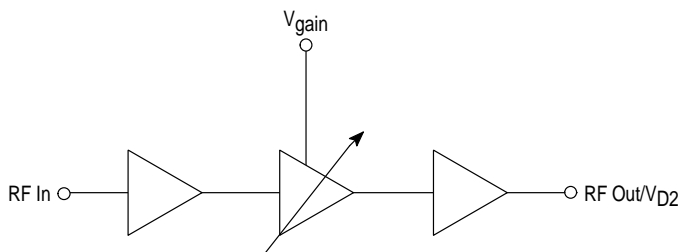

This device contains 12 active transistors.

ORDERING INFORMATION

Device	Operating Temp Range	Package
MRFIC0930R2	$T_A = -30$ to 70°C	SO-8* Tape & Reel
MRFIC0930DMR2		Micro-8** Tape & Reel

*2,500 Units per 16 mm, 13 inch reel.
**2,500 Units per 12 mm, 13 inch reel.

Freescale Semiconductor, Inc.
DEVICE ON LIFETIME BUY

LAST ORDER 28SEP01 LAST SHIP 28SEP02

Freescale Semiconductor, Inc.

MAXIMUM RATINGS (T_A = 25°C, unless otherwise noted)

Symbol	Value	Unit
Supply Voltage	V _{D1} , V _{D2}	5.5 Vdc
RF Input Power	P _{RF}	3 dBm
Gain Control Voltage	V _{gain}	5.5 Vdc
Enable Voltage	RX Enable	5.5 Vdc
Storage Temperature Range	T _{stg}	-65 to 150 °C
Operating Ambient Temperature	T _A	-30 to 70 °C

NOTES: 1. Meets Human Body Model (HBM) ≤750 V and Machine Model (MM) ≤100 V.
2. ESD data available upon request.

RECOMMENDED OPERATING RANGES

Parameter	Symbol	Min	Typ	Max	Unit
RF Frequency	f _{RF}	800	-	1000	MHz
Supply Voltage	V _{D1} , V _{D2}	2.7	-	4.5	Vdc
V _{gain} , High Gain	V _{gain}	-	3.0	-	Vdc
V _{gain} , Low Gain	V _{gain}	-	0	-	Vdc
Rx Enable Voltage, On	Rx Enable	2.7	-	V _{D1} , V _{D2}	Vdc
Rx Enable Voltage, Off	Rx Enable	0	-	0.2	Vdc

NOTE: To bias, apply V_{D1} and V_{D2} before Rx Enable.

ELECTRICAL CHARACTERISTICS (V_{D1}, V_{D2} = 2.8 V, T_A = 25°C, RF = 940 MHz, Rx Enable = 2.8 V, V Gain = 2.8 V, RF In = -30 dBm, unless otherwise noted. Tested in Circuit Shown in Figure 1.)

Characteristic	Symbol	Min	Typ	Max	Unit
RF Gain MRFIC0930 MRFIC0930DM	S ₂₁	17 17.5	19 19	21 21.5	dB
RF Gain (V _{gain} = 0 V)	S ₂₁	-	0.8	4.0	dB
SSB Noise Figure [Note]	NF	-	1.7	3.0	dB
SSB Noise Figure (V _{gain} = 0 V) [Note]	NF	-	10.4	-	dB
RF Input 3rd Order Intercept Point [Note]	IIP3	-12	-9.0	-	dBm
RF Input 3rd Order Intercept Point (V _{gain} = 0 V) [Note]	IIP3	-7.0	-5.7	-	dBm
Input 1.0 dB Gain Compression [Note]	P _{1dB}	-21.5	-20.8	-	dBm
Input 1.0 dB Gain Compression (V _{gain} = 0 V) [Note]	P _{1dB}	-16	-11	-	dBm
Reverse Isolation (S ₁₂)	S ₁₂	-	41	-	dB
Input Return Loss	S ₁₁	-	15	-	dB
Input Return Loss (V _{gain} = 0 V)	S ₁₁	-	15	-	dB
Output Return Loss	S ₂₂	-	15	-	dB
Output Return Loss (V _{gain} = 0 V)	S ₂₂	-	12	-	dB
Supply Current Rx Mode	I _D	-	8.5	12	mA
Supply Current Standby Mode (Rx Enable = 0 V)	I _D	-	20	200	μA

NOTE: Guaranteed by design.

[查询"MRFIC0930"供应商](#)

Figure 1. 900 MHz Test Circuit

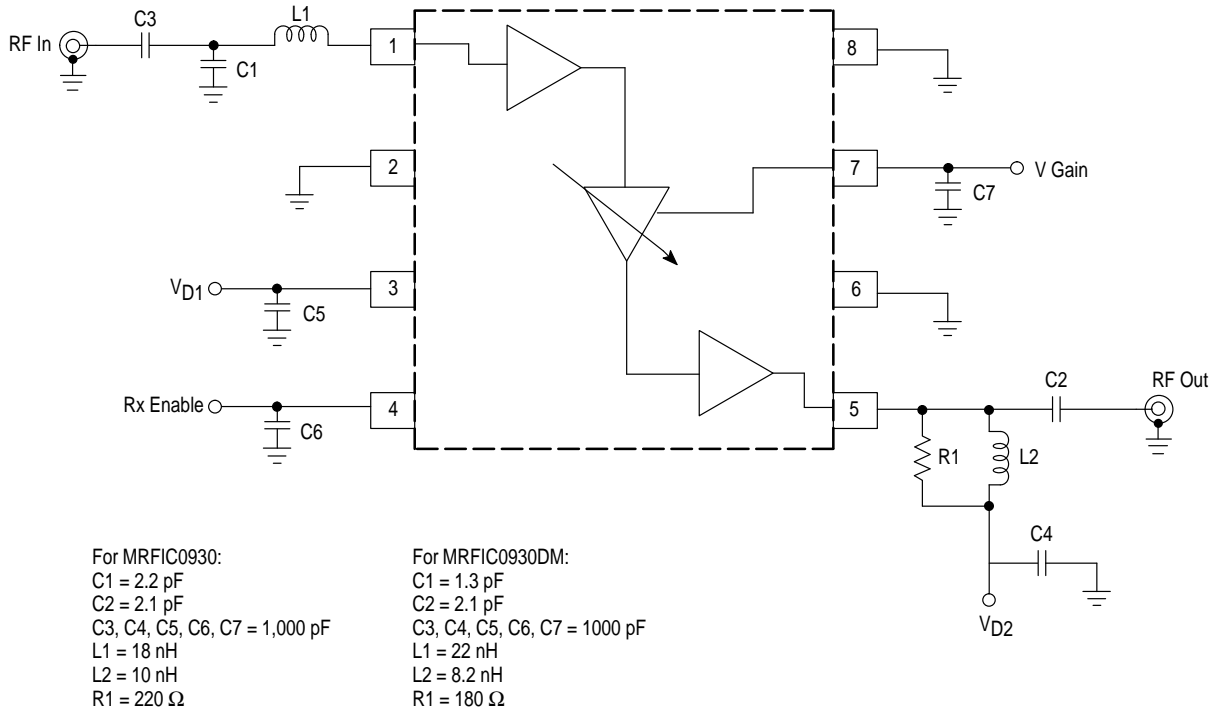

Freescale Semiconductor, Inc.
 DEVICE ON LIFETIME BUY

LAST ORDER 28SEP01 LAST SHIP 28SEP02

TYPICAL CHARACTERISTICS

(For SO-8 Packaged MRFIC0930)

[查询"MRFIC0930"供应商](#)

Figure 2. Reverse Isolation versus Frequency

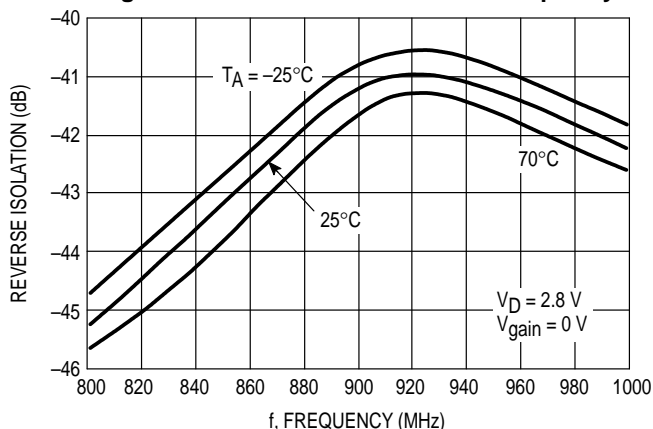

Figure 3. Reverse Isolation versus Frequency

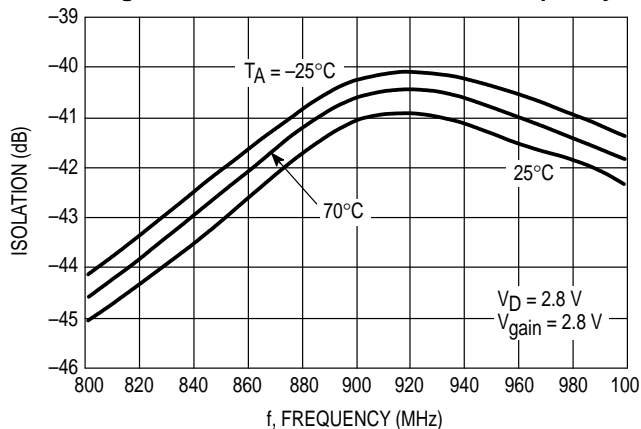

Figure 4. Gain versus Frequency

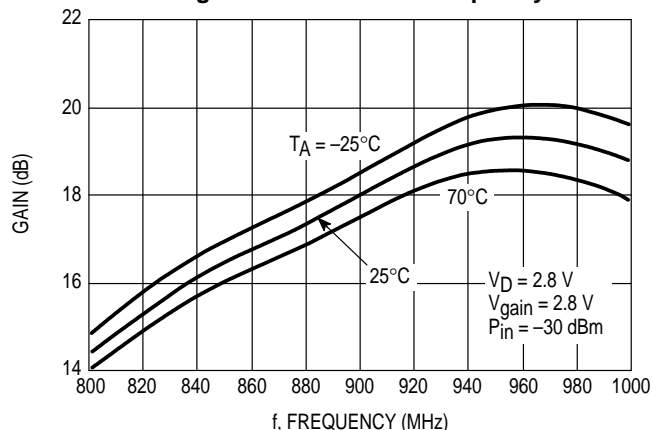

Figure 5. Gain Attenuation versus Frequency

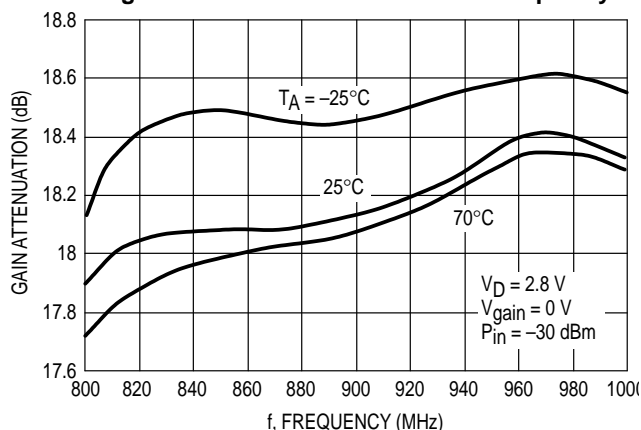

Figure 6. Gain versus Frequency

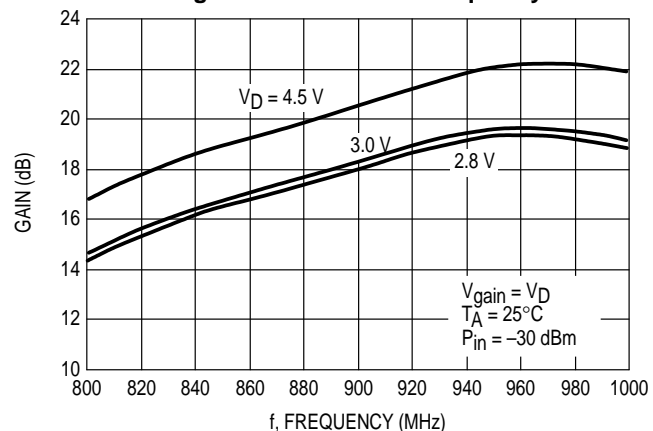
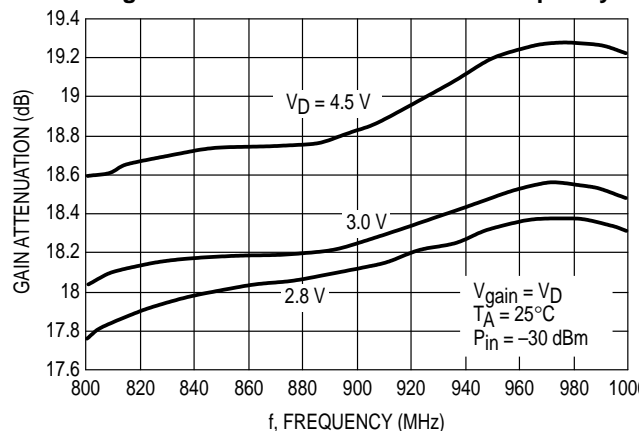

Figure 7. Gain Attenuation versus Frequency



Freescale Semiconductor, Inc. DEVICE ON LIFETIME BUY

LAST ORDER 28SEP01 LAST SHIP 28SEP02

查询"MRFIC0930"供应商

Figure 8. Input Power versus Output Power

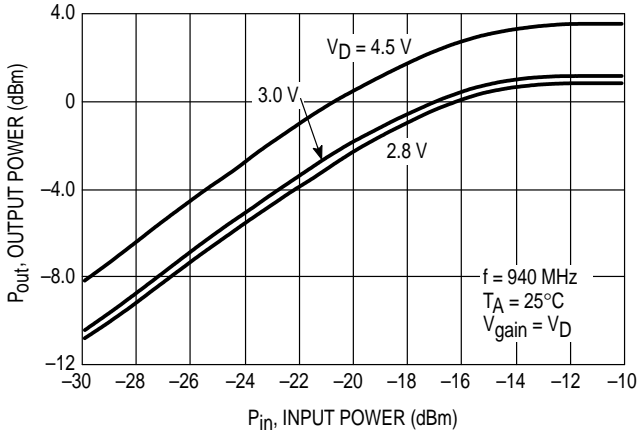

Figure 9. Input Power versus Output Power

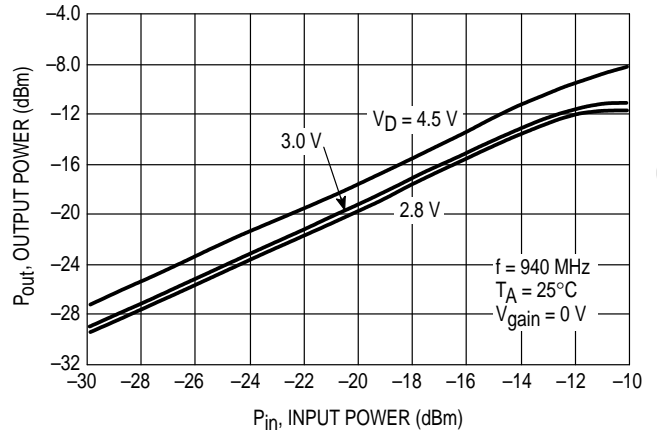

Figure 10. Input Power versus Output Power

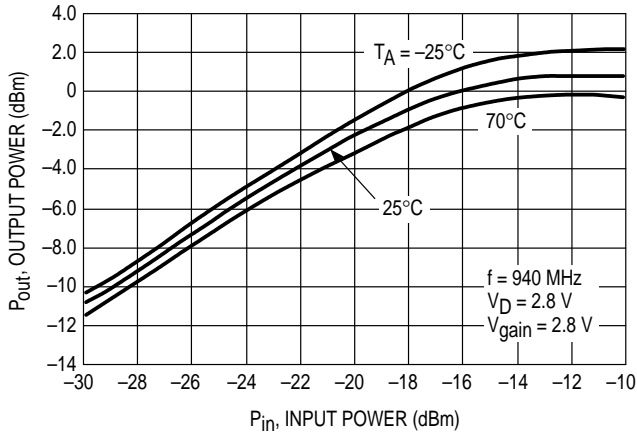

Figure 11. Input Power versus Output Power

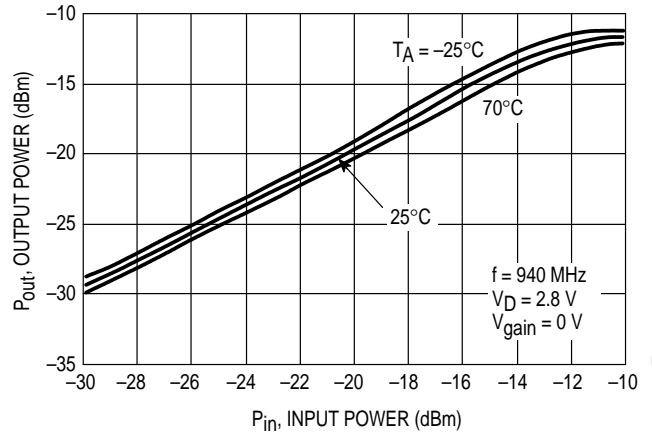

Figure 12. Noise Figure versus Frequency

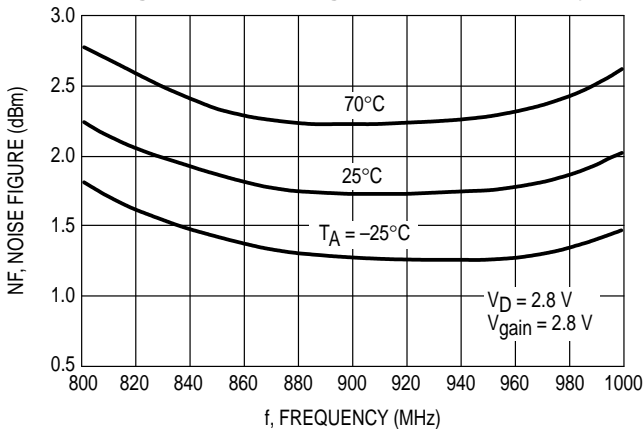
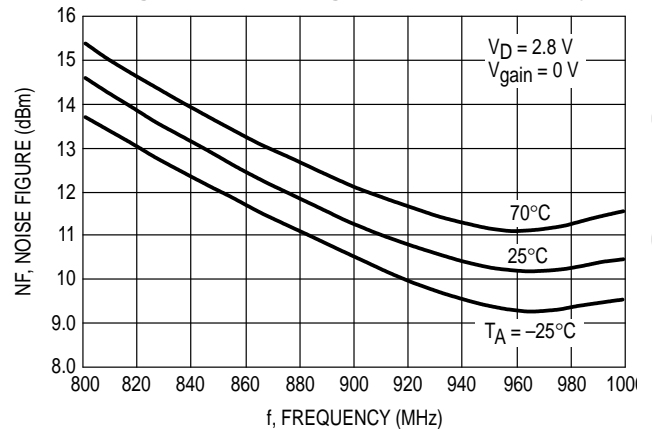

Figure 13. Noise Figure versus Frequency



Freescale Semiconductor, Inc. DEVICE ON LIFETIME BUY

LAST SHIP 28SEP02 LAST ORDER 28SEP01

TYPICAL CHARACTERISTICS (For Micro-8 Packaged MRFIC0930DM)

[查询"MRFIC0930"供应商](#)

Figure 14. Reverse Isolation versus Frequency

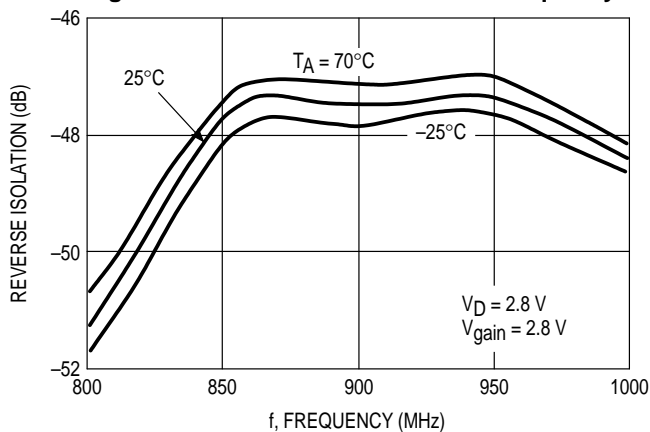

Figure 15. Reverse Isolation versus Frequency

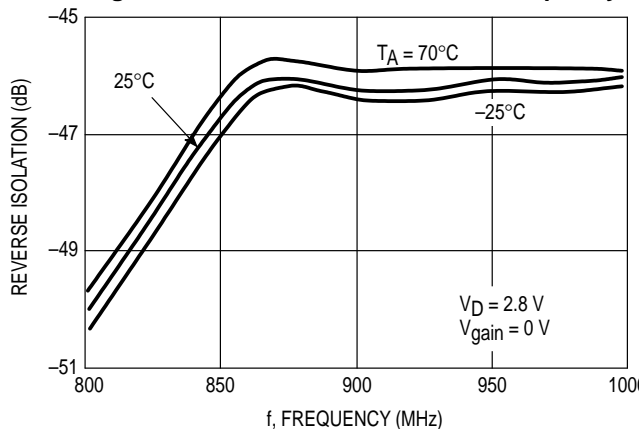

Figure 16. Gain versus Frequency

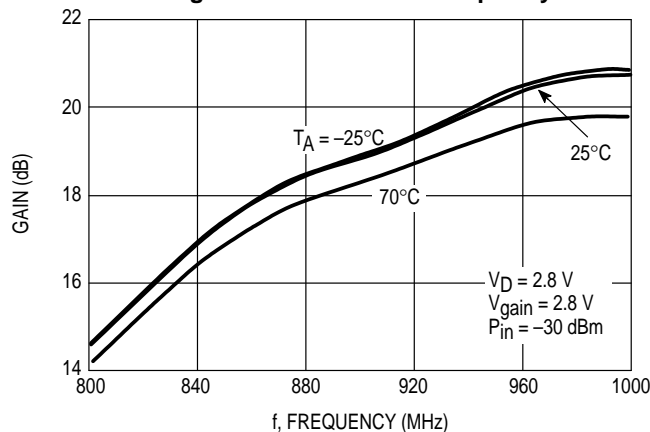

Figure 17. Gain Attenuation versus Frequency

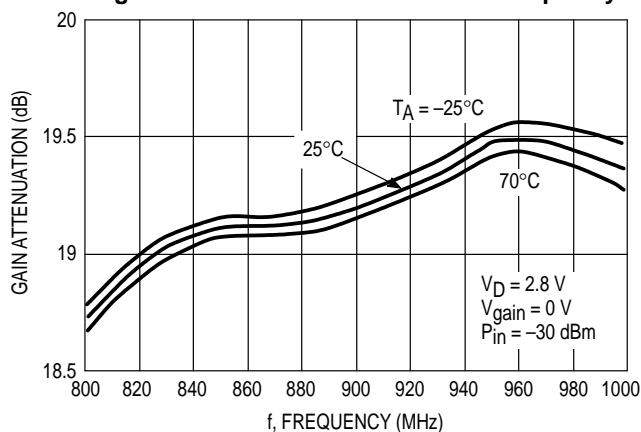

Figure 18. Gain versus Frequency

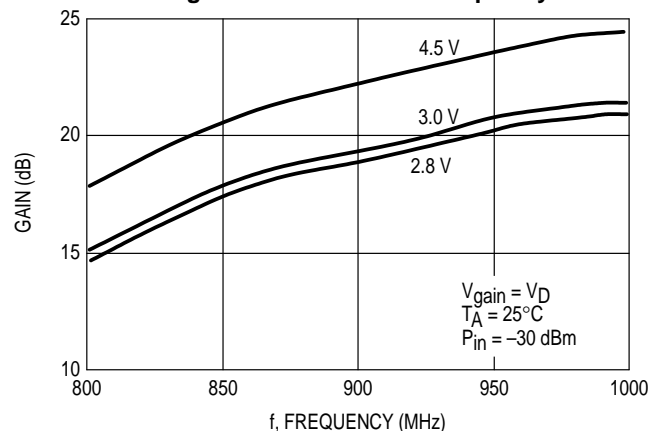
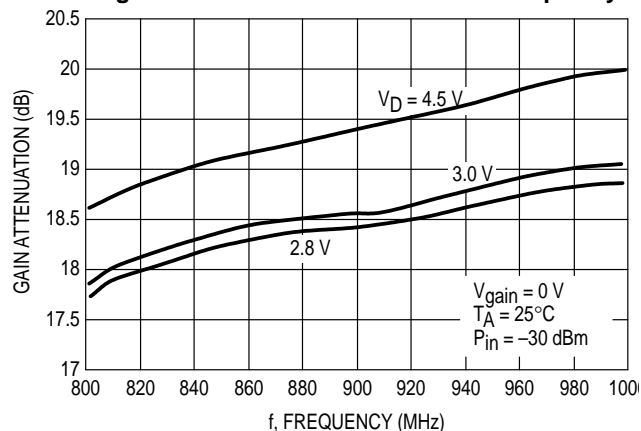

Figure 19. Gain Attenuation versus Frequency



Freescale Semiconductor, Inc.
DEVICE ON LIFETIME BUY

LAST ORDER 28SEP01 LAST SHIP 28SEP02

TYPICAL CHARACTERISTICS (For Micro-8 Packaged MRFIC0930DM)

[查询"MRFIC0930"供应商](#)

Figure 20. Input Power versus Output Power

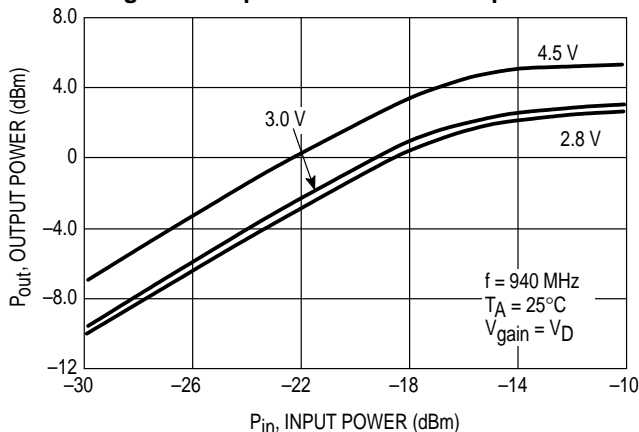

Figure 21. Input Power versus Output Power

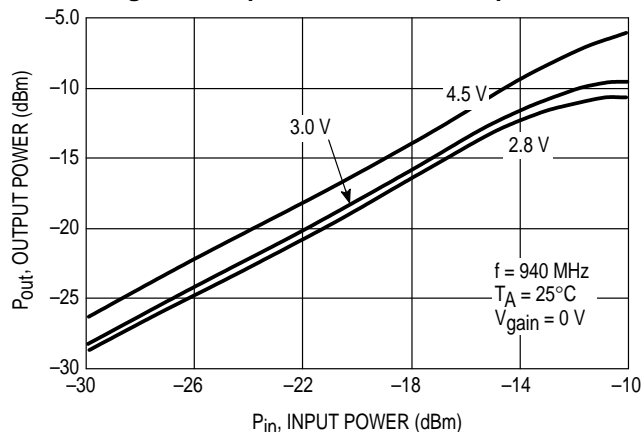

Figure 22. Input Power versus Output Power

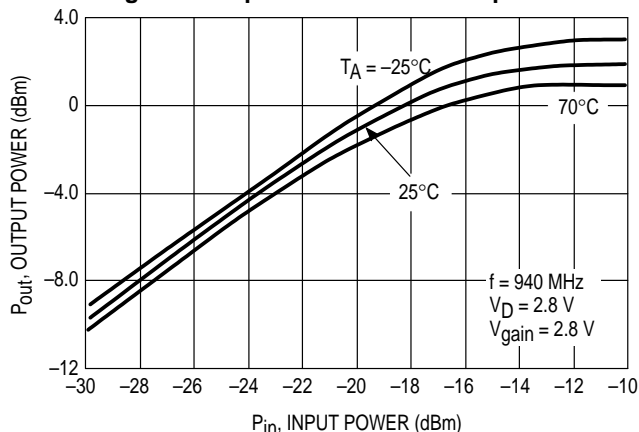

Figure 23. Input Power versus Output Power

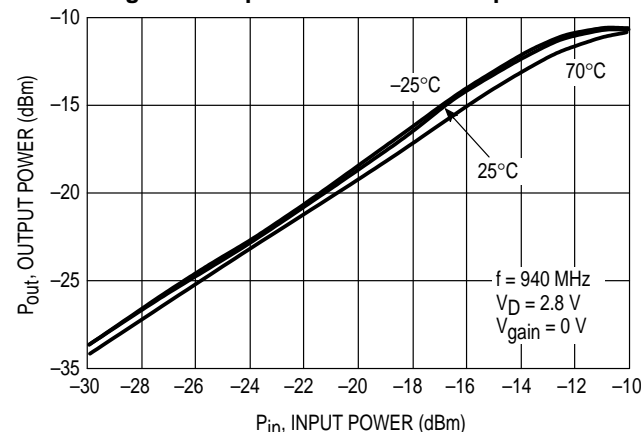

Figure 24. Noise Figure versus Frequency

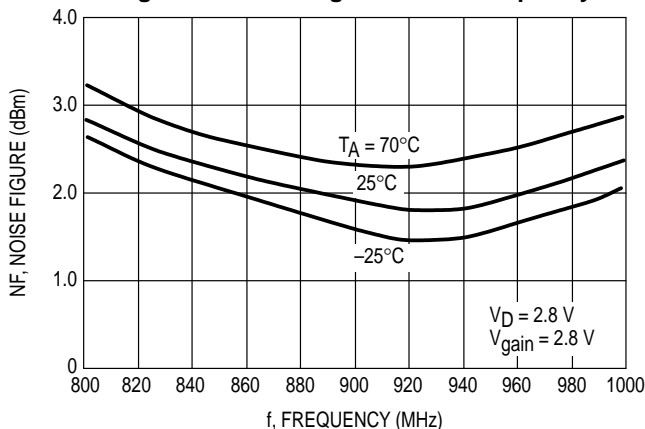
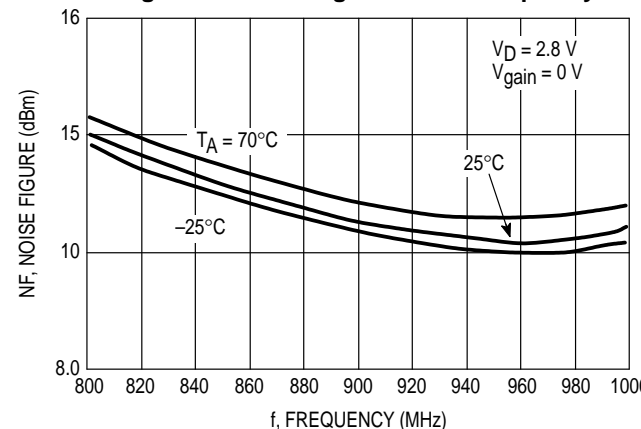

Figure 25. Noise Figure versus Frequency



Freescale Semiconductor, Inc. DEVICE ON LIFETIME BUY

LAST ORDER 28SEP01 LAST SHIP 28SEP02

OUTLINE DIMENSIONS

查询"MRFIC0930"供应商

PLASTIC PACKAGE
CASE 751-06
(SO-8)
ISSUE T

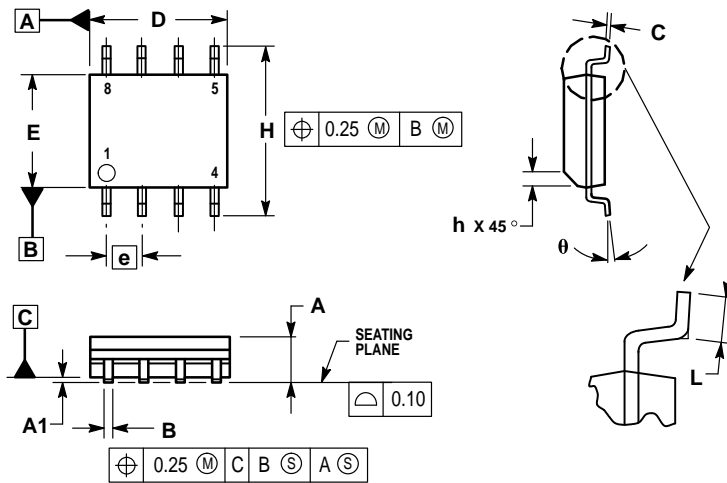

NOTES:

1. DIMENSIONING AND TOLERANCING PER ASME Y14.5M, 1994.
2. DIMENSIONS ARE IN MILLIMETER.
3. DIMENSION D AND E DO NOT INCLUDE MOLD PROTRUSION.
4. MAXIMUM MOLD PROTRUSION 0.15 PER SIDE.
5. DIMENSION B DOES NOT INCLUDE DAMBAR PROTRUSION. ALLOWABLE DAMBAR PROTRUSION SHALL BE 0.127 TOTAL IN EXCESS OF THE B DIMENSION AT MAXIMUM MATERIAL CONDITION.

DIM	MILLIMETERS	
	MIN	MAX
A	1.35	1.75
A1	0.10	0.25
B	0.35	0.49
C	0.19	0.25
D	4.80	5.00
E	3.80	4.00
e	1.27 BSC	
H	5.80	6.20
h	0.25	0.50
L	0.40	1.25
θ	0°	7°

PLASTIC PACKAGE
CASE 846A-02
(Micro-8)
ISSUE D

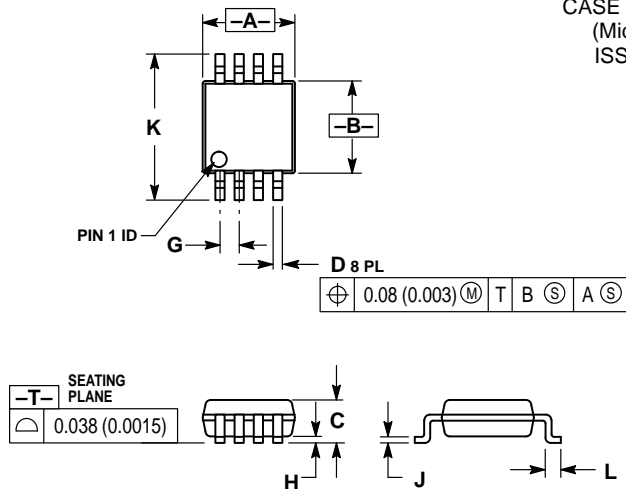

NOTES:

1. DIMENSIONING AND TOLERANCING PER ANSI Y14.5M, 1982.
2. CONTROLLING DIMENSION: MILLIMETER.
3. DIMENSION A DOES NOT INCLUDE MOLD FLASH, PROTRUSIONS OR GATE BURRS. MOLD FLASH, PROTRUSIONS OR GATE BURRS SHALL NOT EXCEED 0.15 (0.006) PER SIDE.
4. DIMENSION B DOES NOT INCLUDE INTERLEAD FLASH OR PROTRUSION. INTERLEAD FLASH OR PROTRUSION SHALL NOT EXCEED 0.25 (0.010) PER SIDE.

DIM	MILLIMETERS		INCHES	
	MIN	MAX	MIN	MAX
A	2.90	3.10	0.114	0.122
B	2.90	3.10	0.114	0.122
C	—	1.10	—	0.043
D	0.25	0.40	0.010	0.016
G	0.65 BSC		0.026 BSC	
H	0.05	0.15	0.002	0.006
J	0.13	0.23	0.005	0.009
K	4.75	5.05	0.187	0.199
L	0.40	0.70	0.016	0.028

Motorola reserves the right to make changes without further notice to any products herein. Motorola makes no warranty, representation or guarantee regarding the suitability of its products for any particular purpose, nor does Motorola assume any liability arising out of the application or use of any product or circuit, and specifically disclaims any and all liability, including without limitation consequential or incidental damages. "Typical" parameters which may be provided in Motorola data sheets and/or specifications can and do vary in different applications and actual performance may vary over time. All operating parameters, including "Typicals" must be validated for each customer application by customer's technical experts. Motorola does not convey any license under its patent rights nor the rights of others. Motorola products are not designed, intended, or authorized for use as components in systems intended for surgical implant into the body, or other applications intended to support or sustain life, or for any other application in which the failure of the Motorola product could create a situation where personal injury or death may occur. Should Buyer purchase or use Motorola products for any such unintended or unauthorized application, Buyer shall indemnify and hold Motorola and its officers, employees, subsidiaries, affiliates, and distributors harmless against all claims, costs, damages, and expenses, and reasonable attorney fees arising out of, directly or indirectly, any claim of personal injury or death associated with such unintended or unauthorized use, even if such claim alleges that Motorola was negligent regarding the design or manufacture of the part. Motorola and are registered trademarks of Motorola, Inc. Motorola, Inc. is an Equal Opportunity/Affirmative Action Employer.

Mfax is a trademark of Motorola, Inc.

How to reach us:

USA/EUROPE/Locations Not Listed: Motorola Literature Distribution;
P.O. Box 5405, Denver, Colorado 80217. 1-303-675-2140 or 1-800-441-2447

JAPAN: Motorola Japan Ltd.; SPD, Strategic Planning Office, 141,
4-32-1 Nishi-Gotanda, Shinagawa-ku, Tokyo, Japan. 81-3-5487-8488

Customer Focus Center: 1-800-521-6274

Mfax™: RMFAX0@email.sps.mot.com – TOUCHTONE 1-602-244-6609
Motorola Fax Back System – US & Canada ONLY 1-800-774-1848
– http://sps.motorola.com/mfax/

ASIA/PACIFIC: Motorola Semiconductors H.K. Ltd.; Silicon Harbour Centre,
2, Dai King Street, Tai Po Industrial Estate, Tai Po, N.T., Hong Kong.
852-26629298

HOME PAGE: <http://motorola.com/sps/>



For More Information On This Product,
Go to: www.freescale.com

MRFIC0930/D

Freescale Semiconductor, Inc.
DEVICE ON LIFETIME BUY

LAST ORDER 28SEP01 LAST SHIP 28SEP02