



LM1895/LM2895 Audio Power Amplifier

General Description

The LM1895 is a 6V audio power amplifier designed to deliver 1W into 4Ω. Utilizing a unique patented compensation scheme, the LM1895 is ideal for sensitive AM radio applications. This new circuit technique exhibits lower noise, lower distortion, and less AM radiation than conventional designs. The amplifier's supply range (3V–9V) is ideal for battery operation. The LM1895 is packaged in an 8-pin miniDIP for minimum PC board space. For higher supplies ($V_S > 9V$) the LM2895 is available in an 11-lead single-in-line package. The 11-lead package has been redesigned, resulting in a slightly degraded thermal characteristic shown in the figure Device Dissipation vs Ambient Temperature.

Features

- Guaranteed low crossover distortion
- Low AM radiation

- Low noise
- 3V, 4Ω, $P_O = 250$ mW
- Wide supply operation 3V–15V (LM2895)
- Low distortion
- No turn on "pop"
- Smooth waveform clipping
- 8-pin miniDIP (LM1895)
- 12V, 4Ω, $P_O = 4W$ (LM2895)
- Tested for low crossover distortion

Applications

- Compact AM-FM radios
- Battery operated tape player amplifiers
- Line driver

Typical Applications

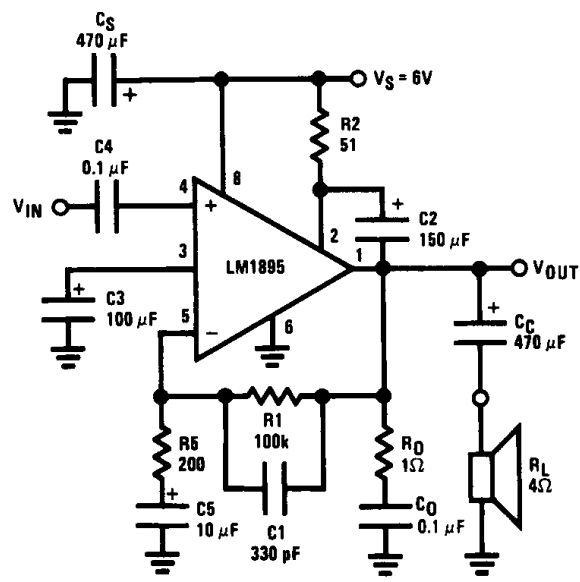

FIGURE 1. LM1895 with $A_V = 500$, $BW = 5$ kHz, AM Radio Application ($V_{IN} = 4.2$ mV for Full Power Output)

Order Number LM1895N or LM2895P
See NS Package Number N08E or P11A

TL/H/7919-1

Absolute Maximum Ratings

If Military/Aerospace specified devices are required, please contact the National Semiconductor Sales Office/Distributors for availability and specifications.

Supply Voltage

LM1895

$V_S = 12V$

LM2895

$V_S = 18V$

Operating Temperature (Note 1)

0°C to +70°C

Storage Temperature

-65°C to +150°C

Junction Temperature

150°C

Lead Temperature (Soldering, 10 sec.)

260°C

Electrical Characteristics

Unless otherwise specified, $T_A = 25^\circ\text{C}$, $A_V = 200$ (46 dB). For the LM1895, $V_S = 6V$ and $R_L = 4\Omega$. For the LM2895, $T_{TAB} = 25^\circ\text{C}$, $V_S = 12V$ and $R_L = 4\Omega$. Test circuit shown in Figure 2.

Parameter	Conditions	LM1895			LM2895			Units
		Min	Typ	Max	Min	Typ	Max	
Supply Current	$P_O = W$		8	14		12	20	mA
Operating Supply Voltage		3		10	3		15	V
Output Power	THD = 10%, $f = 1\text{ kHz}$							
LM1895N	$V_S = 6V, R_L = 4\Omega$	0.9	1.1					W
	$V_S = 9V, R_L = 8\Omega$		1.1					W
LM2895P	$V_S = 12V, R_L = 4\Omega$				3.6	4.3		W
	$V_S = 12V, R_L = 8\Omega$					2.5		W
Distortion	$f = 1\text{ kHz}$							
	$P_O = 50\text{ mW}$		0.27			0.27		%
	$P_O = 0.5W$		0.20			0.20		%
	$P_O = 1.0W$					0.15		%
	$f = 20\text{ kHz}, P_O = 100\text{ mW}, V_S = 3.6V$			3.0			3.0	%
Crossover Distortion	$f = 20\text{ kHz}, R_L = 4\Omega, P_O = 100\text{ mW}, V_{CC} = 3.6V$			3			3	%
Power Supply Rejection Ratio (PSRR)	$C_{BY} = 100\ \mu\text{F}, f = 1\text{ kHz}, C_{IN} = 0.1\ \mu\text{F}$ Output Referred, $V_{RIPPLE} = 250\text{ mV}$	40	52		40	52		dB
Noise	Equivalent Input Noise $R_S = 0$, $C_{IN} = 0.1\ \mu\text{F}, BW = 20 - 20\text{ kHz}$ CCIR/ARM Wideband		1.4			1.4		μV
			1.4			1.4		μV
			2.0			2.0		μV
DC Output Level		2.8	3.0	3.2	5.6	6.0	6.4	V
Input Impedance		50	150	350	50	150	350	k Ω
Input Offset Voltage			5			5		mV
Input Bias Current			120			120		nA

Note 1: For operation at ambient temperature greater than 25°C, the LM1895/LM2895 must be derated based on a maximum junction temperature using a thermal resistance which depends upon mounting techniques.

Typical Performance Characteristics

LM2895 Device Dissipation vs Ambient Temperature

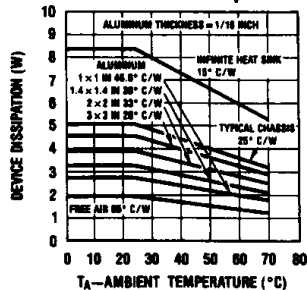

LM1895 Maximum Device Dissipation vs Ambient Temperature

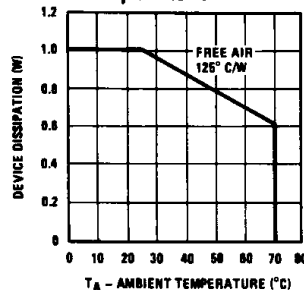

-3 dB Bandwidth vs Voltage Gain for Stable Operation

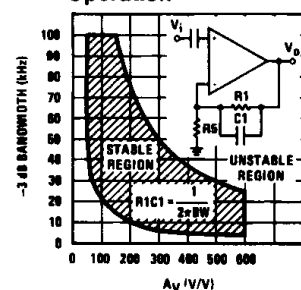

TL/H/7919-2

Typical Performance Characteristics (Continued)

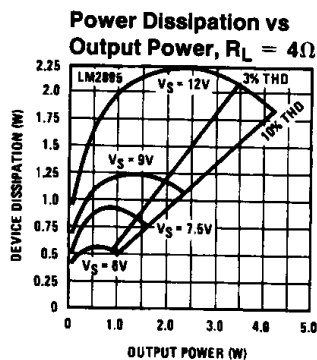
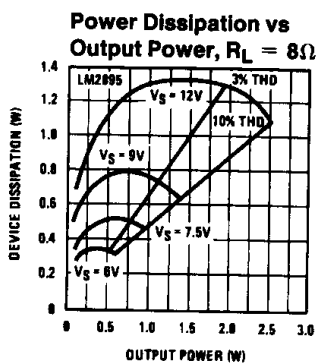
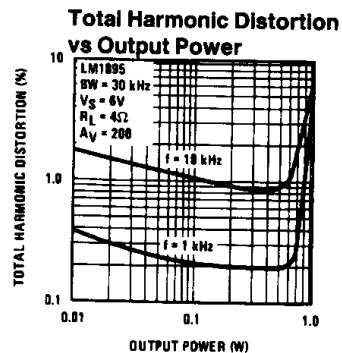
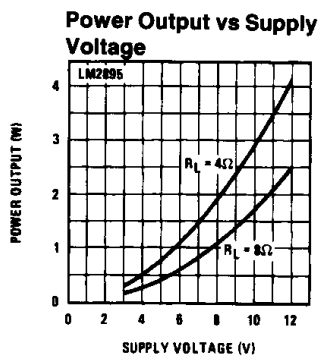
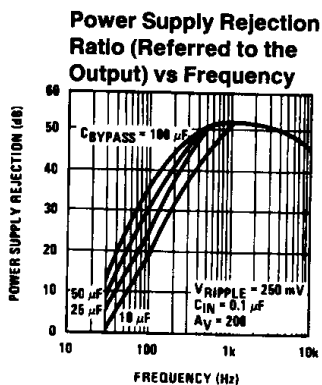
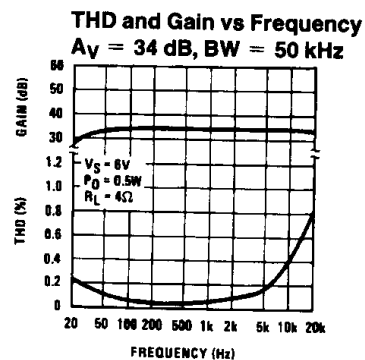
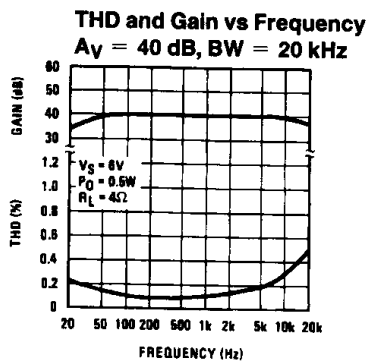
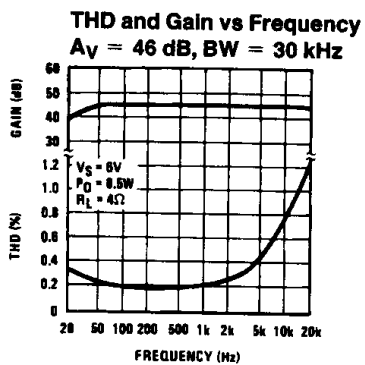
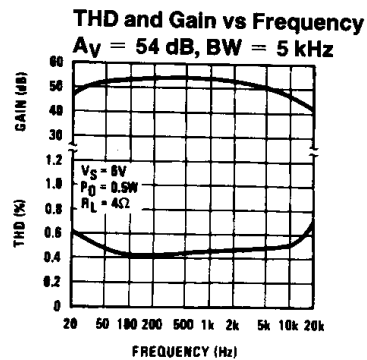
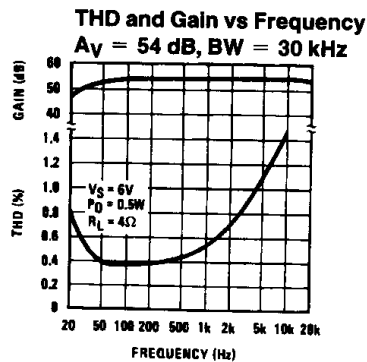
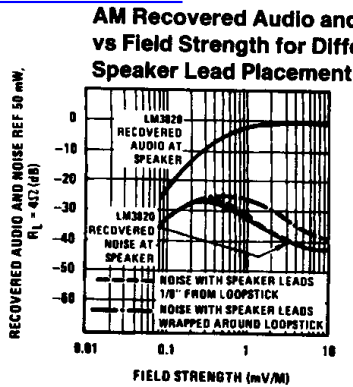

TL/H/7919-3

Equivalent Schematic

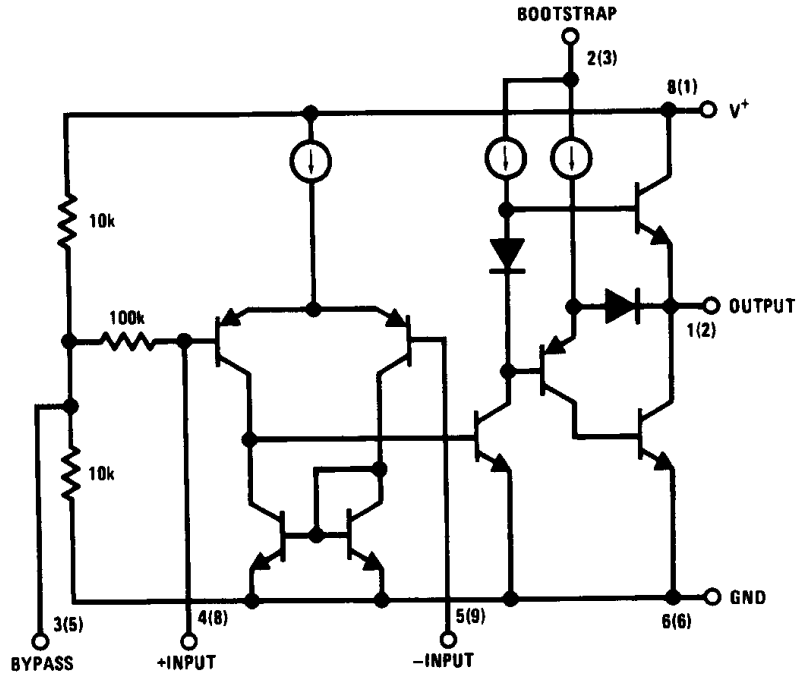

Pin 7 no connection on LM1895
 Pins 4, 7, 10, 11 no connection on LM2895
 () indicates pin number for LM2895

TL/H/7919-4

Typical Applications (Continued)

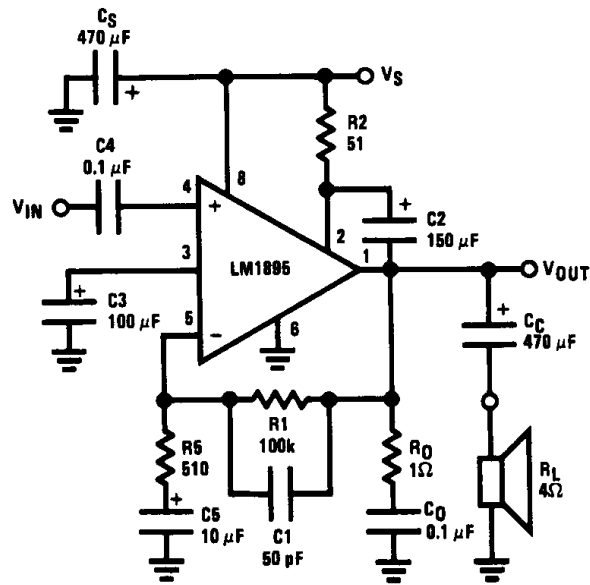

FIGURE 2. Amplifier with $A_v = 200$, $BW = 30$ kHz

TL/H/7919-5

External Components (Figure 2)

Components	Comments
1. R1, R5	Sets voltage gain, $A_V = 1 + R1/R5$
2. R2	Bootstrap resistor sets drive current for output stage and allows pin 2 to go above V_S
3. R_O	Works with C_O to stabilize output stage
4. C_4	Input coupling capacitor. Pin 4 is at a DC potential of $V_S/2$. Low frequency pole set by: $f_L = \frac{1}{2\pi R_{IN}C_4}$
5. C_5	Feedback capacitor. Ensure unity gain at DC. Also a low frequency pole at: $f_L = \frac{1}{2\pi R_5C_5}$
6. C_2	Bootstrap capacitor, used to increase drive to output stage. A low frequency pole is set by: $f_L = \frac{1}{2\pi R_2C_2}$
7. C_1	Compensation capacitor. This stabilizes the amplifier and adjusts the bandwidth. See curve of bandwidth vs allowable gain
8. C_3	Improves power supply rejection. (See Typical Performance Curves). Increasing C_3 increases turn-on delay
9. C_C	Output coupling capacitor. Isolates pin 1 from the load. Low frequency pole set by: $f_L = \frac{1}{2\pi C_C R_L}$
10. C_O	Works with R_O to stabilize output stage
11. C_S	Provides power supply filtering

Connection Diagrams

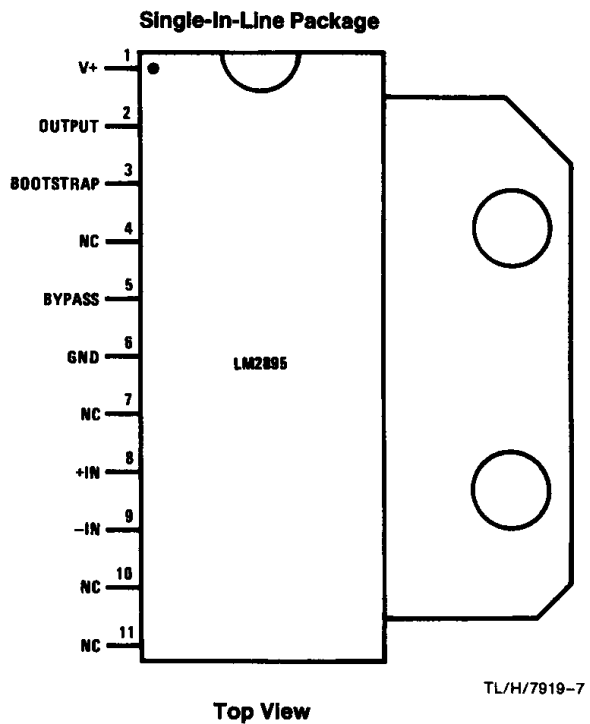
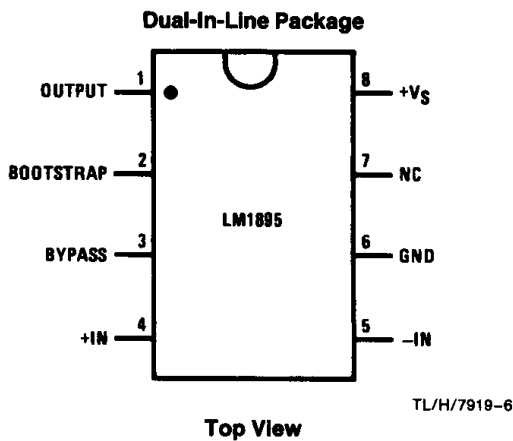

Application Hints

AM Radios

The LM1895/LM2895 have been designed to fill a wide range of audio power applications. A common problem with IC audio power amplifiers has been poor signal-to-noise performance when used in AM radio applications. In a typical radio application, the loopstick antenna is in close proximity to the audio amplifier. Current flowing in the speaker and power supply leads can cause electromagnetic coupling to the loopstick, resulting in system oscillation. In addition, most audio power amplifiers are not optimized for lowest noise because of compensation requirements. If noise from the audio amplifier radiates into the AM section, the sensitivity and signal-to-noise ratio will be degraded.

The LM1895 exhibits extremely low wideband noise due in part to an external capacitor C1 which is used to tailor the bandwidth. The circuit shown in *Figure 2* is capable of a signal-to-noise ratio in excess of 60 dB referred to 50 mW. Capacitor C1 not only limits the closed loop bandwidth, it also provides overall loop compensation. Neglecting C5 in *Figure 2*, the gain is:

$$A_V(S) = \frac{S + A_V\omega_o}{S + \omega_o}$$

$$\text{where } A_V = \frac{R1 + R5}{R5}, \quad \omega_o = \frac{1}{R1C1}$$

A curve of -3 dB BW (ω_o) vs A_V is shown in the Typical Performance Curves.

Figure 3 shows a plot of recovered audio as a function of field strength in $\mu\text{V}/\text{M}$. The receiver section in this example is an LM3820. The power amplifier is located about two inches from the loopstick antenna. Speaker leads run parallel to the loopstick and are $1/8$ inch from it. Referenced to a 20 dB S/N ratio, the improvement in noise performance over conventional designs is about 10 dB. This corresponds to an increase in usable sensitivity of about 8.5 dB.

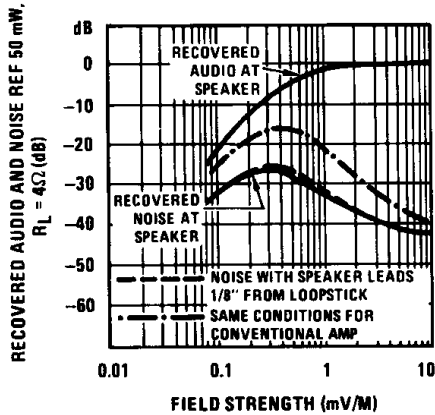

FIGURE 3. Improved AM Sensitivity Over Conventional Design

TL/H/7919-8

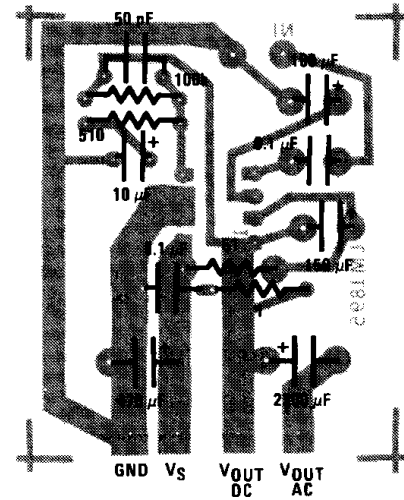

FIGURE 4. Printed Circuit Board Layout for LM1895

TL/H/7919-9